

CATALOG 3.1

# LINEAR LED LIGHTING SYSTEM

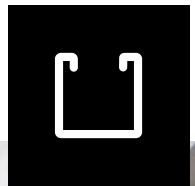

## NEW PROFILES

Brand new products  
1450, 3100, 8500, 8800 and more!

## NEW CATEGORIES

Luminaires, recessed downlights,  
track light system and more!





## ABOUT LUMENTRUSS

We are proud to introduce the new **LUMENTRUSS V3.0** catalogue, featuring our extensive range of profiles for architectural LED lighting. Through time, we have created many new extrusions and accessories to suit your very needs.





























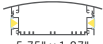

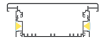

























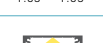











Our LED profiles are easily installed and are perfect for residential, commercial and industrial purposes. Made in Canada with 6063-T5 aluminum, our LED profiles can be used both indoors and outdoors, in dry or wet locations. They all meet the North American woodworking standards. Our products are custom-made and available in sections up to 20 linear feet. They are suitable for any space and can be anodized or painted with the color of your choice to match your décor. These extrusions can be installed on a surface, recessed or even installed on a multitude of suspension lights.

Find out about our LTPS dimmable drivers on electronic low-voltage dimmers allowing you to connect to different automation systems and controls in place. The uses of the **LUMENTRUSS** range are literally limitless! We work daily to expand our range of profiles and accessories to meet all your needs.

# 100% CUSTOMIZED

We create architectural lighting to your specifications. Our profiles can be extensively customized, offering you endless creative possibilities.

# INDEX

	<b>Optics</b> Pages 4-5		<b>4400 Profile</b> Pages 78-79 0.48" x 0.48"		<b>TOOBYFOR</b> Pages 168-169 1.75" x 3.25"
	<b>Legend</b> Page 6		<b>4500 Profile</b> Pages 80-81 0.63" x 0.56"		<b>TAO</b> Pages 170-171 4.20" x 1.50"
	<b>How to Order</b> Page 7		<b>5000 Profile</b> Pages 84-85 0.86" x 0.43" / 0.73" x 0.65"		<b>SILO</b> Pages 172-173 Ø 2.75"
	<b>1100 Profile</b> Pages 10-11 0.74" x 0.20"		<b>5350 Profile</b> Pages 86-87 0.93" x 0.45"		<b>PIKE</b> Pages 174-175 2.37" x 3.25"
	<b>1200 Profile</b> Pages 12-13 0.74" x 0.45"		<b>5450 Profile</b> Pages 88-89 1.10" x 0.54"		<b>APSID</b> Pages 178-179 7.14" x 7.89"
	<b>1300 Profile</b> Pages 14-15 1.03" x 0.45"		<b>5560 Profile</b> Pages 90-91 0.71" x 0.16"		<b>ARCUS</b> Pages 180-181 5.27" x 10.34"
	<b>1400 Profile</b> Pages 16-17 0.74" x 0.67"		<b>7400(7420) Profile</b> Pages 94-95 5.75" x 1.97"		<b>GEMINUS</b> Pages 182-183 6.85" x 6.85"
	<b>1450 Profile</b> Pages 18-21 0.925" x 1"		<b>7400(7450) Profile</b> Pages 96-97 5.98" x 2.22"		<b>NIDUS</b> Pages 184-185 7.00" x 6.00"
	<b>1460 Profile</b> Pages 22-25 1" x 1.42"		<b>7500 Profile</b> Pages 98-99 Ø 1.5"		<b>SULCUS</b> Pages 186-187 8" x 3.25"
	<b>1500 Profile</b> Pages 26-27 1.34" x 0.67"		<b>7650 Profile</b> Pages 100-103 Ø 3.00"		<b>LATUS</b> Pages 188-189 10.25" x 1.74"
	<b>1580 Profile</b> Pages 28-31 1.61" x 0.78"		<b>7800 Profile</b> Pages 104-105 1.06" x 1.63"		<b>EXA Luminaire</b> Pages 192-195 2.95" x 4.13"
	<b>1590 Profile</b> Pages 32-35 2.37" x 1.26"		<b>7850 Profile</b> Pages 106-107 Ø 1.30" x 1.19"		<b>FullMoon Luminaire</b> Pages 196-203 17.75" or 35.5" x 2.95"
	<b>1650 Profile</b> Pages 36-37 1.46" x 0.72"		<b>8500 Profile</b> Pages 110-113 2.40" x 1.85"		<b>8700 Profile (serzo)</b> Pages 204-207 Ø 36"/54"/72" x 2"/4"
	<b>1690 Profile</b> Pages 38-39 1.57" x 0.63"		<b>8540 Profile</b> Pages 114-121 3" x 2.98"		<b>STRUSS Luminaire</b> Pages 208-209 2.95" x 3.98"
	<b>1800 Profile</b> Pages 40-41 2.18" x 1.14"		<b>8550 Profile</b> Pages 122-129 4" x 1.85"		<b>Taskline Luminaire</b> Pages 210-213 1.5" x 2.6"
	<b>2000 Profile</b> Pages 44-45 0.79" x 0.79"		<b>8800 Profile</b> Pages 130-131 1.65" x 1.65"		<b>Light Task Lamp</b> Pages 214-217 41.5" x 76.77"
	<b>2200 Profile</b> Pages 46-49 0.79" x 0.79"		<b>8860 Profile</b> Pages 132-133 3.25" x 0.625"		<b>Recessed downlight Omega</b> Pages 220-223
	<b>2400 Profile</b> Pages 50-53 0.79" x 0.79"		<b>8870 Profile</b> Pages 134-137 4" x 0.7"		<b>Track light system Traxx</b> Pages 224-231
	<b>3100 Profile</b> Pages 56-57 2.19" x 0.67"		<b>8900 Profile</b> Pages 138-139 6.57" x 1.50"		<b>LED Engines</b> Pages 234-245
	<b>3150 Profile</b> Pages 58-61 2.91" x 0.67"		<b>9400 Profile</b> Pages 142-143 1.63" x 1.63"		<b>Flexible Neon</b> Pages 246-247
	<b>3200 Profile</b> Pages 62-63 5.35" x 0.67"		<b>9820 Profile</b> Pages 144-155 2.95" x 1.97"		<b>Power Supplies</b> Pages 248-249
	<b>4200 Profile</b> Pages 66-69 0.51" x 0.51"		<b>9850 Profile</b> Pages 156-157 2.95" x 3.98"		<b>Sample Kits</b> Pages 251
	<b>4250 Profile</b> Pages 70-73 0.97" x 0.63"		<b>LuxSleeve</b> Pages 160-163 0.87" x 0.47"		<b>Appendix</b> Pages 252-254
	<b>4260 Profile</b> Pages 74-77 0.51" x 0.51"		<b>TIGA</b> Pages 166-167 1.73" x 3.25"		

# OUR LED LIGHT SOURCES

## BRIGHT, BEAUTIFUL LIGHT OUR LED LIGHT SOURCES

### FULL RANGE

We offer a comprehensive range of flexible LED engines in a variety of LED types, sizes, densities, colors, and voltages.

- The LED engines have excellent flexibility but also a solid construction.
- A variety of densities are available, from 18 LEDs per foot for ambient lighting, to well over 73 LEDs per foot for high intensity, dot-free appearance.
- We offer a complete palette of industry standard white and color LEDs.

### CERTIFIED QUALITY TOP PERFORMANCE

From the specifications and design to the sourcing and manufacturing processes, rigorous quality controls backed by leading certification authorities ensure that you get a product that is guaranteed to perform to expectations.

- Certified by the Underwriters Laboratories and Intertek for compliance with the US and Canadian lighting and electrical codes and regulations.
- Compliance with RoHS European standards for quality and reduction of hazardous materials.
- California's Title 24 lighting compliance.

We settle for nothing less than the best in LED light sources. Energy efficiency is a key parameter in any application, and our LED engines rank consistently in the top range of energy efficient LED products on the market.

- Luminous efficacy of over 80 lumens per Watt in our standard 3528 and 5050 engines.
- Up to 130 lumens per watt in the high-power 2835 engines.



Lumen package	Physical		Electrical		Lumens/foot			
	Width	Density, LED/ft	DC Input	Rated Power, W/ft	Clear lens	Optiflex lens	Opal lens	Prime lens
LP0	5/16" (8mm)	18.3	12V 24V	1.5	124	109	64	94
LP1	5/16" (8mm)	36.6	24V	1.5	155	136	80	118
LP2	5/16" (8mm)	36.6	12V 24V	2.9	246	217	128	186
LP3	5/16" (8mm)	54.9	24V	4.4	297	262	154	225
LHP	2/5" (10mm)	73.2	24V	7	676	595	350	511

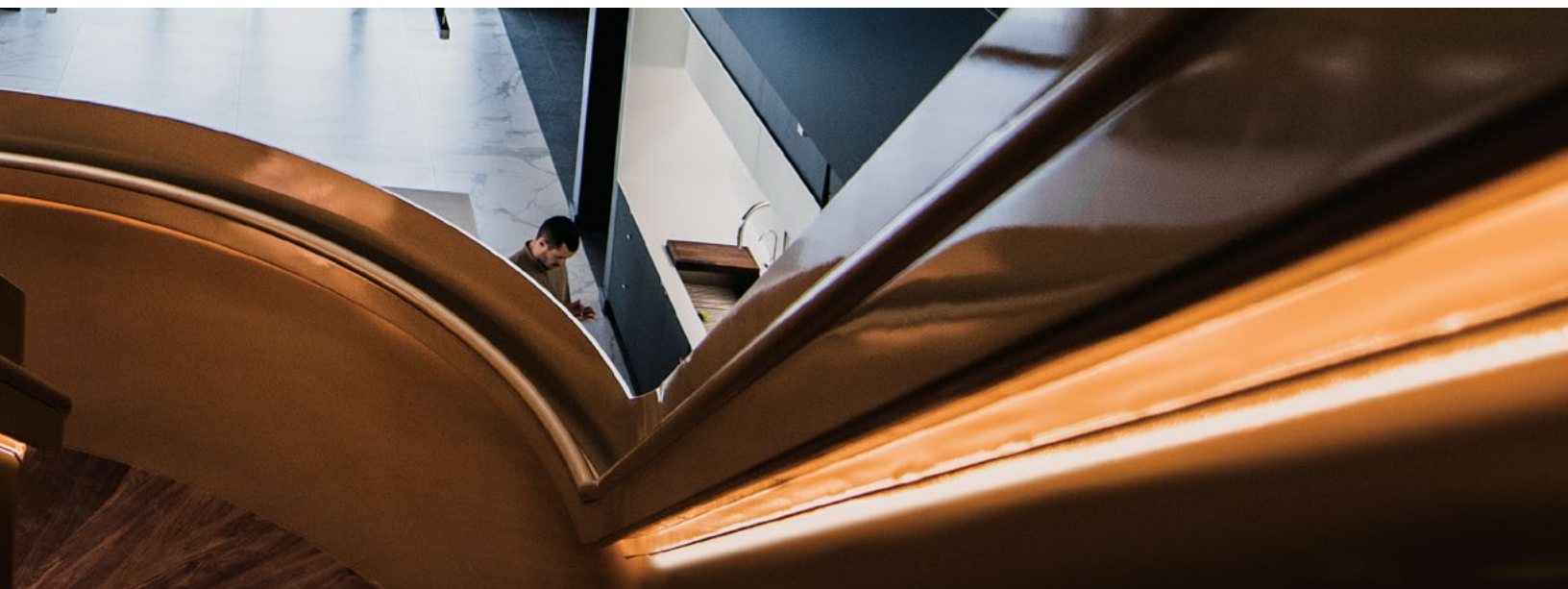

## LIFELIKE COLORS

No more bleak colors and ugly hue shifts that have plagued the post-incandescent lighting world. Enjoy vivid, lifelike colors, and benefit from the superior energy efficiency of our white LED engines at the same time.

- Our whites provide a color rendering index (CRI) that is over 95, for a healthier, more natural lighting, particularly useful in color-critical environments such as retail, art & design, fashion, etc.



CRI < 60

CRI > 95

## VIVID REDS

The red color is essential in all our perception of the world, from food to healthy-looking skintones. While many LEDs on the market boast a high CRI, few display bright reds properly.

- Our LED engines feature an R9 (bright red) value of over 60, for a vivid display of red tones. We are also in the processing of continually improving it, with many products' R9 being already well over 60.



R9 < 30

R9 > 60

## CUSTOM TAILORED

Some of our luminaires use custom LED light sources to optimize the form factor, improve the heat dissipation, and maximize the performance and efficiency.

- Contact us with your project concept, and we can design and source the manufacturing of one-of-a-kind LED light sources to your very own requirements.

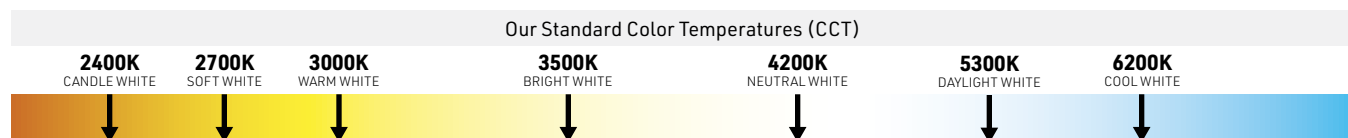

Compliance with California's Title 24 Building Energy Efficiency Program, with a CRI over 90 and a luminous efficacy of over 50 lumens per Watt.



# OUR OPTICS

## CUSTOMIZE YOUR LIGHTING WITH OUR COMPLETE RANGE OF LENSES

Without lens



### CLEAR

This basic lens is designed to maximize the light output.

- Addition of components to increase flexibility
- Increases CCT of 50-80 Kelvin
- cRUus recognized component
- UV resistant
- Transmits 96.5% of the original light output from the LED source

### OPTIFLEX

The frosted lens is developed for standard lighting, allowing an optimal light diffusion while maintaining high brightness.

- Addition of components to increase flexibility
- CCT reduction of 120-140 Kelvin
- cRUus recognized component
- UV resistant
- Transmits 85% of the original light output from the LED source

### OPAL

A lens developed for thin profiles, allowing the elimination of the hot spots of the LED light source.

- Faded effect of the light source (minimum 120 LED per meter not to see the dots)
- CCT reduction of 190-240 Kelvin
- cRUus recognized component
- UV Resistant
- Transmits 65% of the original light output from the LED source

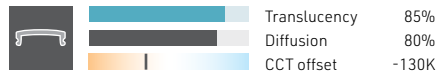
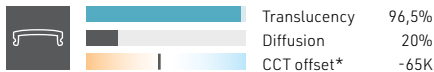



## EXTRAS

Many lenses are available in extra shapes and materials, offering a greater creative freedom in the design of unique lighting fixtures.

- Volumetric lenses provide light diffusion over a wider angle, as well as a dot-free appearance of the source due to increased inner space
- cRUus component Certification
- UV Resistant



## SPREAD

With its integrated prismatic grooves, this lens scatters the light and increases the beam angle to better light nearby objects.

- Addition of components to increase flexibility
- CCT reduction of 50-80 Kelvin
- cRUus recognized component
- UV resistant
- Transmits 95% of the original light output from the LED source



## FOCUS

A converging lens that is designed to focus the light beam, for targeted and focused lighting.

- Addition of components to increase flexibility
- CCT reduction of 50-80 Kelvin
- cRUus recognized component
- UV resistant
- Transmits 85% of the original light output from the LED source



## PRIME

A brand new optical diffuser Lumentruss has been working on to give you a no dots solution with more light output.

- Combines the qualities of the opal and optiflex lenses without their downsides
- cRUus recognized component
- Same effect as our opal lens but 45% more efficient
- Gives a uniform light
- Designed to give a no dots solution while keeping a much more interesting light effect and higher Lumen rate
- CCT 80% more accurate
- 50% more flexible

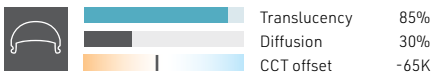
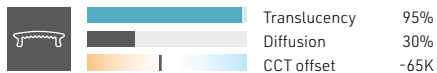

\*CCT offset: average change of the LED source's original Correlated Color Temperature, in Kelvin



# LEGEND

Symbols used and their meaning



Made in North America (plastic and aluminum components).



Architectural-grade 6063-T5 aluminum alloy with a 2.68 g/cm density and superior mechanical quality.



Components recognized by UL (Underwriters Laboratories) / IFDR Low-voltage Lighting Systems, Power Units, Luminaires, and Fittings



Certified by UL (Underwriters Laboratories) for Canada and the United States concerning North American safety and electrical standards governing this product / IFAM Surface-mounted LED Luminaires



For wet and dry locations.



Indicates product has been evaluated using the Standard for Low Voltage Lighting Systems, UL 2108 and the United States requirements from the Standard for LED Light Sources for use in Lighting Products, UL 8750. CNL indicates investigation to CSA Standard for Luminaires, C22.2 No. 250.0, and CSA Standard for General Requirements for Luminaires C22.2 No. 9.



5 year limited warranty on aluminum profiles.



The LED engine can be inserted into a resistant silicone sheath, making it waterproof, with an IP68 ingress protection rating.



Designed to give a uniform light without hot spots, with an opal or prime lens and a LED engine of 120 LEDs per meter or more.



Designed to allow CNC machining for a more extensive customization.



Sets of endcaps and brackets are also available with screws and bolts in stainless steel.



Choice of custom colors available on special order (minimum quantities required, please contact our specialists for details).



Standard finishings (Wood Series).



Standard plaster finishing (Gypsum Series).



For each of our Lumentruss luminaire that's made with recycled wood from Quebec, a tree will be planted. Help us help the environment!



Products that meet verified carbon standards by not having travelled more than 500 kilometers in their manufacturing process, thus promoting a sustainable development. We are committed to meet 2020 global carbon emission reduction goals while promoting renewable energy projects. We care about climate change and global warming.



California Title 24 Building Energy Efficiency Standards are designed to ensure new and existing buildings achieve energy efficiency and preserve outdoor and indoor environmental quality.



Designed to be levelled to the wall surface using joint compound.



Designed to assemble a non-linear luminaire; L-shaped, square, rectangular, etc.



Designed with a device that automatically switches the light on and off.



## WARNING

Important electrical notice

1. Use only certified Class II components not exceeding 30V DC or 15V AC for installation in wet locations, and a maximum of 60V DC or 42.4V AC for installation in a dry or humid area.
2. Do not exceed 5 amps per circuit from 12VDC or 24VDC, for compliance with Class 2 standards of the American and Canadian electrical codes.
3. Products must be installed in full accordance with applicable electrical and building codes and regulations applicable. Installation should be performed by a qualified electrician in accordance with electrical standards and relevant local codes.



# HOW TO ORDER

## Example

For each of the available profiles, you will get a presentation page followed by another one containing a detailed list of all compatible components. By referring to the example provided at the bottom of this page, choose the parts needed and indicate them using the quick order codes provided below the components' descriptions.

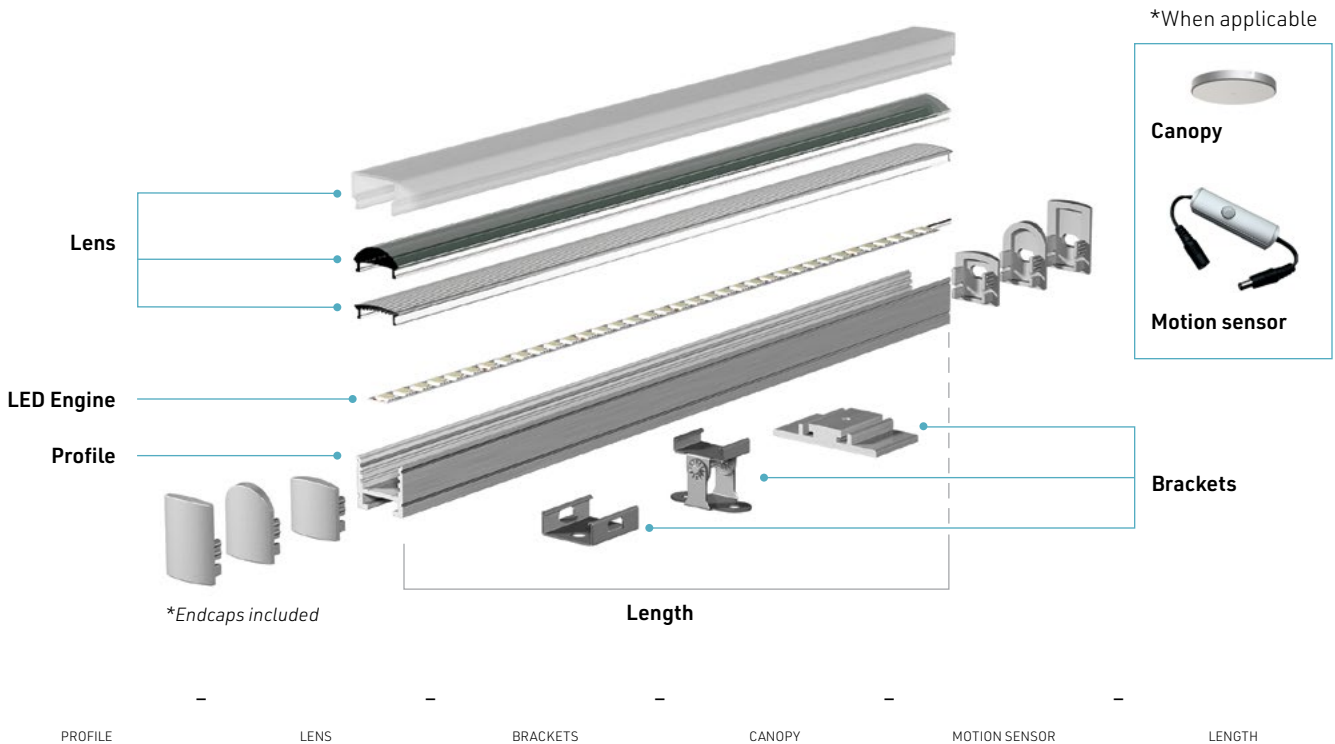

**\*NOTE:** By default, LumenTruss will install the appropriate endcaps according to options chosen. No endcaps option is available if mentioned when ordered.

### Ordering example

To order a linear lighting fixture using a single LED engine, you can choose a profile from the 1000 Series. For a swiveling floodlight with a narrow beam (featured on the right), you can choose the 1400 profile, a Focus lens and the swivel surface mount. Finally, specify the needed total length of the fixture.

By default, the length is specified in inches, in accordance with North American woodworking standards. However, should you need to specify sizes in any other imperial or metric system units, please make sure to indicate the units used in the last field (length).

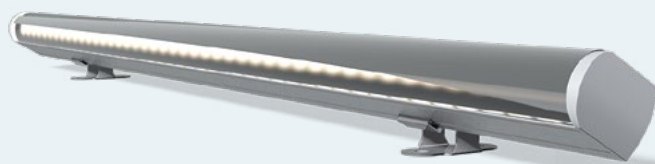
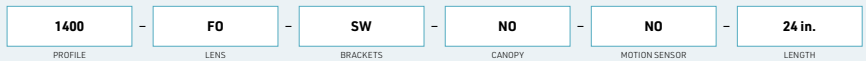

### SEND ORDER :

Email : [orders@lumentruss.com](mailto:orders@lumentruss.com)  
 Phone : 1-855-384-3384  
 Fax : 514-903-0649



# 1000 SERIES





# 1100 PROFILE

1000 Series



## Cross-section dimensions:

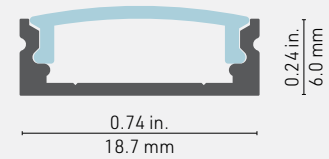

## THE THINNEST OF THE 1000 SERIES

This profile is **the thinnest of the 1000 Series** being only 6 mm (0.236 inch) thick and 18.7 mm (0.736 inch) wide, and is compatible with most of our LED engines. Perfect for tight spots, it will be very discreet and will stand out.

### FEATURES

- The most compact profile of the 1000 Series, only 6mm thick.
- Custom length by sections of 2 to 240 inches (6m).
- Application guide for 10mm (3/8 inch) LED engine or less.
- Made of ALCOA 6063-T5 aluminum alloy increasing heat dissipation.
- Its use increases the lifetime of your LED engine.
- Compatible with multiple installation accessories.
- Designed to meet North American woodworking standards.

### OPTIONS

















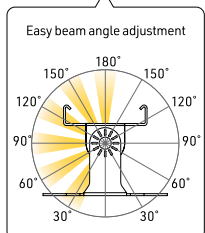

### LED ENGINE COMPATIBILITY

Compatible with LED engines up to **14mm** wide.



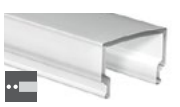











### LINEAR WEIGHT

0.060 lbs/ft, 0.089 kg/m (without lens)



PROFILE	LENSES	MOUNTING HARDWARE	LENGTH
 1100 - 1100 Profile, alu	 CL - Clear lens	 FL - Flat bracket	Custom length by sections of 2 to 240 inches (6m).
	 SP - Spread lens	 45 - 45° Corner bracket	
	 OX - Optiflex lens	 SW - Swivel bracket 180°	
	 OP - Opal lens	 <p>Easy beam angle adjustment</p>	
	 PR - Prime lens		
	 BK - Black lens	 3M - Mounting tape, double face	
	 OX3D - Square 3D, Optiflex	 NO - No mounting hardware	
	 OP3D - Square 3D, Opal		
	 SIL - Silens Serie 1000		
	 NO - No lens		

<b>1100</b>			
PROFILE	LENS	MOUNTING HARDWARE	LENGTH

COLOR TEMPERATURE	LUMEN PACKAGE*	LEAD IN/OUT	USAGE	POWER SUPPLY/CONTROL	*NOTES
<ul style="list-style-type: none"> <li> 24 - 2400K</li> <li> 27 - 2700K</li> <li> 30 - 3000K</li> <li> 35 - 3500K</li> <li> 42 - 4200K</li> <li> 53 - 5300K (LHP only)</li> <li> 62 - 6200K (LP only)</li> <li> WD1 - WarmDim 14W</li> <li> WD2 - WarmDim 17W</li> <li> TW1 - Tunable White 11W</li> <li> TW2 - Tunable White 19W</li> <li> RGB1 - RGB 14W</li> <li> RGB2 - RGB 19W</li> <li> RGBW1 - 3000K</li> <li> RGBW2 - 3000K 4in1</li> </ul>	<ul style="list-style-type: none"> <li>LP0 - 128 LM / 1.5W FT / 90+CRI</li> <li>LP1 - 160 LM / 1.5W FT / 90+CRI</li> <li>LP2 - 255 LM / 3.0W FT / 90+CRI</li> <li>LP3 - 308 LM / 4.5W FT / 90+CRI</li> <li>LP4 - 400 LM / 5.8W FT / 90+CRI</li> <li>LHP - 700 LM / 7.0W FT / 95+CRI</li> </ul> <p>Note: Not applicable for Warmdim Tunable White &amp; RGB color temperatures</p>	<ul style="list-style-type: none"> <li>HW3 - Hardwire 3 FT</li> <li>HW6 - Hardwire 6 FT</li> <li>HW9 - Hardwire 9 FT</li> <li>HWX - Hardwire custom FT</li> <li>DC3 - DC plug 3 FT</li> <li>DC6 - DC plug 6 FT</li> <li>DC9 - DC plug 9 FT</li> <li>DCX - DC plug custom FT</li> <li>NO - No lead</li> </ul>	<ul style="list-style-type: none"> <li>I - IP22 indoor dry location</li> </ul>	<ul style="list-style-type: none"> <li>A - Non-dimming</li> <li>B - ELV dimming 120V AC</li> <li>C - ELV dimming 120/277 VAC**</li> <li>D - 0/10V dimming 120/277 VAC</li> <li>E - Non-dimming DC plug in</li> <li>F - DMX</li> <li>G - Lutron - HI-LUME PREMIER 0,1% Eco System 24V/96W</li> <li>I - Casambi CBU-A2D-0/10V-DALI-Bluetooth 100/277 VAC</li> <li>J - Casambi CBU-PWM4-4CH-Bluetooth 100/277 VAC</li> <li>K - Casambi CBU-TED-CV-Trail edge dim-Bluetooth 120 VAC</li> <li>NO - No driver</li> </ul>	<p>*The light output is provided in lumens per foot, for a CCT of 4200K and a clear lens. Please refer to the optics page for CCT and translucency conversion factors.</p> <p>** Only available in 96W - 24V Driver</p> <div style="border: 1px solid black; padding: 2px; display: inline-block;"> <p>TITLE <b>24</b> www.lumentruss.com</p> </div>
COLOR TEMPERATURE CCT	LUMEN PACKAGE	LEAD IN LEAD OUT	USAGE	POWER SUPPLY/CONTROL	

# 1200 PROFILE

1000 Series



## Cross-section dimensions:

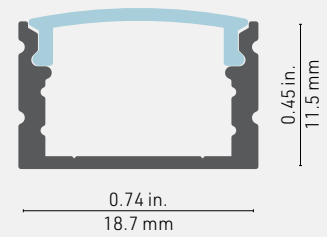

## LIGHTING WITHOUT HOT SPOTS!

This profile is designed to ensure that the LED source is invisible, offering uniform and soft lighting for the eyes. A compact and versatile luminaire!

### FEATURES

- Designed to give a uniform light without hot spots with an opal or prime lens.
- Custom length by sections of 2 to 240 inches (6m).
- Application guide for 10mm (3/8-inch) LED engine or less.
- Made of ALCOA 6063-T5 aluminum alloy increasing heat dissipation.
- Its use increases the lifetime of your LED engine.
- Compatible with multiple installation accessories.
- Designed to meet North American woodworking standards.

### OPTIONS



### LED ENGINE COMPATIBILITY























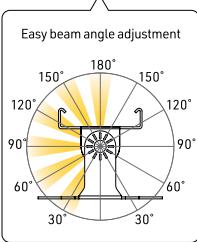

IP22: Compatible with LED engines up to **14mm** wide.



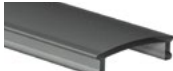



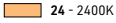

IP68: Compatible with LED engines up to **10mm** wide.

### LINEAR WEIGHT

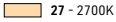
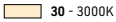
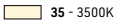
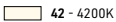
0.099 lbs/ft, 0.148 kg/m (without lens)

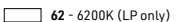
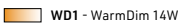
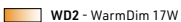

PROFILE	LENSES	MOUNTING HARDWARE	MOTION SENSORS*	LENGTH
 1200 - 1200 Profile, alu	 CL - Clear lens	 FL - Flat bracket	 SEN1 - 30 sec. Embedded	Custom length by sections of 2 to 240 inches (6m).
 1201 - 1200 Profile, black	 SP - Spread lens	 45 - 45° Corner bracket	 SEN2 - 30 sec. Outside extrusion	
 1202 - 1200 Profile, white	 OX - Optiflex lens	 SW - Swivel bracket 180°	 SEN3 - 4 min. Embedded	
 120X - 1200 Profile, custom color <b>IMPORTANT:</b> Give RAL color No See Appendix 1 on page 158	 OP - Opal lens		 SEN4 - 4 min. Outside extrusion	
<b>RAL NUMBER</b>	 PR - Prime lens		 3M - Mounting tape, double face	
	 BK - Black lens	 NO - No mounting hardware	 NO - No sensor	
	 FO - Focus lens		<b>*NOTES</b> All motion sensors: - Max 36W/12V or 72W/24V - Can only be used with non-dimmable power supplies	
	 SIL - Silens Serie 1000			
	 NO - No lens			
PROFILE	LENS	MOUNTING HARDWARE	MOTION SENSOR	

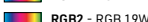
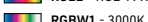
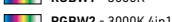
COLOR TEMPERATURE	LUMEN PACKAGE*	LEAD IN/OUT	USAGE	POWER SUPPLY/CONTROL	*NOTES
 24 - 2400K	LP0 - 128 LM / 1.5W FT / 90+CRI	HW3 - Hardware 3 FT	I - IP22 indoor dry location	A - Non-dimming	*The light output is provided in lumens per foot, for a CCT of 4200K and a clear lens. Please refer to the optics page for CCT and translucency conversion factors.  ** Only available in 96W - 24V Driver  
 27 - 2700K	LP1 - 160 LM / 1.5W FT / 90+CRI	HW6 - Hardware 6 FT	0 - IP68 wet/damp location	B - ELV dimming 120V AC	
 30 - 3000K	LP2 - 255 LM / 3.0W FT / 90+CRI	HW9 - Hardware 9 FT	<b>Note:</b> IP68 not available with motion sensor option.	C - ELV dimming 120/277 VAC**	
 35 - 3500K	LP3 - 308 LM / 4.5W FT / 90+CRI	HWX - Hardwire custom FT		D - 0/10V dimming 120/277 VAC	
 42 - 4200K	LP4 - 400 LM / 5.8W FT / 90+CRI	DC3 - DC plug 3 FT		E - Non-dimming DC plug in	
 53 - 5300K (LHP only)	LHP - 700 LM / 7.0W FT / 95+CRI	DC6 - DC plug 6 FT		F - DMX	
 62 - 6200K (LP only)	<b>Note:</b> Not applicable for WarmDim Tunable White & RGB color temperatures	DC9 - DC plug 9 FT		G - Lutron - HI-LUME PREMIER 0,1% Eco System 24V/96W	
 WD1 - WarmDim 14W		DCX - DC plug custom FT		I - Casambi CBU-A2D-0/10V-DALI-Bluetooth 100/277 VAC	
 WD2 - WarmDim 17W		NO - No lead		J - Casambi CBU-PWM4-4CH-Bluetooth 100/277 VAC	
 TW1 - Tunable White 11W				K - Casambi CBU-TED-CV-Trail edge dim-Bluetooth 120 VAC	
 TW2 - Tunable White 19W				NO - No driver	
 RGB1 - RGB 14W					
 RGB2 - RGB 19W					
 RGBW1 - 3000K					
 RGBW2 - 3000K 4in1					
COLOR TEMPERATURE CCT	LUMEN PACKAGE	LEAD IN LEAD OUT	USAGE	POWER SUPPLY/CONTROL	

# 1300 PROFILE

1000 Series



## Cross-section dimensions:

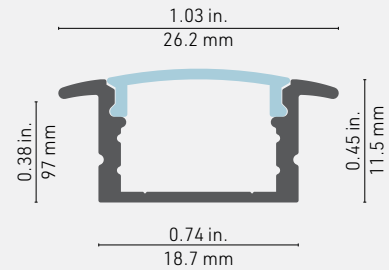

## A COMPACT AND RECESSED PROFILE

Here is a **compact and recessed** profile allowing you to make the LED light source invisible. The edges on each side of this extrusion allow for a recessed installation, while having understated style with its discreet and neat appearance.

### FEATURES

- Designed to give a uniform light without hot spots with an opal or prime lens.
- The edge allows recessed installation. To be installed in a 19mm (3/4-inch) groove.
- Custom length by sections of 2 to 240 inches (6m).
- Application guide for 10mm (3/8-inch) LED engine or less.
- Made of ALCOA 6063-T5 aluminum alloy increasing heat dissipation.
- Its use increases the lifetime of your LED engine.
- Compatible with multiple installation accessories.
- Designed to meet North American woodworking standards.

### OPTIONS



### LED ENGINE COMPATIBILITY

IP22: Compatible with LED engines up to **14mm** wide.







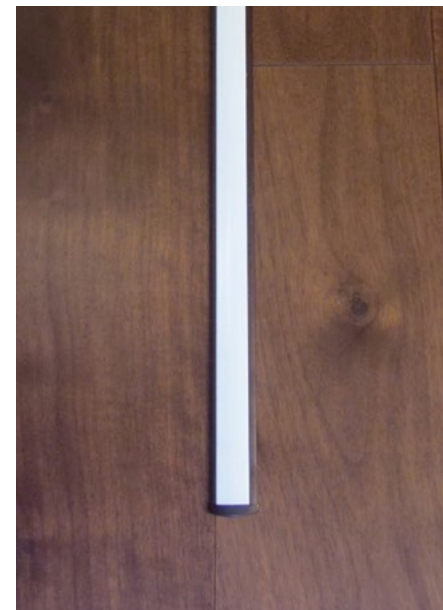
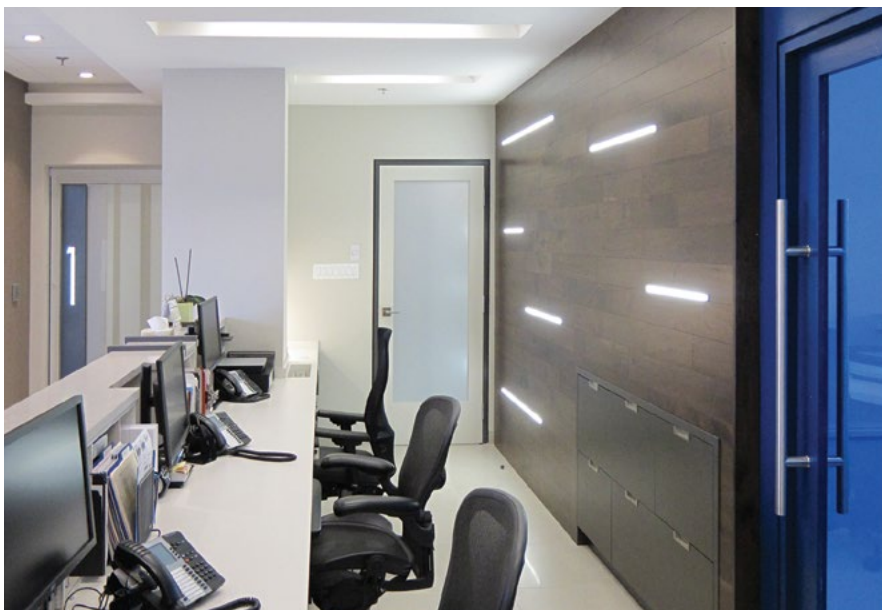



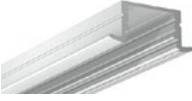
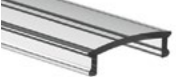

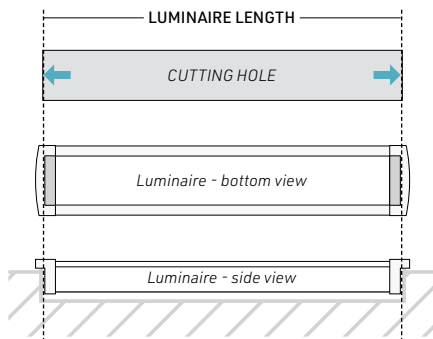

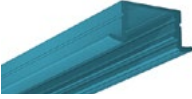

IP68: Compatible with LED engines up to **10mm** wide.

### LINEAR WEIGHT

0.115 lbs/ft, 0.171 kg/m (without lens)





PROFILE	LENSES	MOUNTING HARDWARE	MOTION SENSORS*	LENGTH
 <p><b>1300</b> - 1300 Profile, alu</p>	 <p><b>CL</b> - Clear lens</p>	 <p><b>FL</b> - Flat bracket</p>	 <p><b>SEN1</b> - 30 sec. Embedded</p>	<p>Custom length by sections of 2 to 240 inches (6m).</p> <p><b>*NOTE:</b> Follow this diagram to calculate the correct length</p> 
 <p><b>1301</b> - 1300 Profile, black</p>	 <p><b>SP</b> - Spread lens</p>	 <p><b>3M</b> - Mounting tape, double face</p>	 <p><b>SEN3</b> - 4 min. Embedded</p>	
 <p><b>130X</b> - 1300 Profile, custom color</p> <p><b>IMPORTANT:</b> Give RAL color № See Appendix 1 on page 158</p>	 <p><b>OX</b> - Optiflex lens</p>	 <p><b>NO</b> - No mounting hardware</p>	 <p><b>SEN5</b> - Intergrated proximity hand motion sensor</p>	
RAL NUMBER	 <p><b>OP</b> - Opa lens</p>	 <p><b>NO</b> - No sensor</p>	<p><b>*NOTES</b></p> <p>All motion sensors:                      - Max 36W/12V or 72W/24V                      - Can only be used with non-dimmable power supplies</p>	
	 <p><b>PR</b> - Prime lens</p>			
	 <p><b>BK</b> - Black lens</p>			
	 <p><b>SIL</b> - Silens Serie 1000</p>			
	 <p><b>NO</b> - No lens</p>			
PROFILE	LENS	MOUNTING HARDWARE	MOTION SENSOR	LENGTH

COLOR TEMPERATURE	LUMEN PACKAGE*	LEAD IN/OUT	USAGE	POWER SUPPLY/CONTROL	*NOTES
<p><b>24</b> - 2400K</p> <p><b>27</b> - 2700K</p> <p><b>30</b> - 3000K</p> <p><b>35</b> - 3500K</p> <p><b>42</b> - 4200K</p> <p><b>53</b> - 5300K (LHP only)</p> <p><b>62</b> - 6200K (LP only)</p> <p><b>WD1</b> - WarmDim 14W</p> <p><b>WD2</b> - WarmDim 17W</p> <p><b>TW1</b> - Tunable White 11W</p> <p><b>TW2</b> - Tunable White 19W</p> <p><b>RGB1</b> - RGB 14W</p> <p><b>RGB2</b> - RGB 19W</p> <p><b>RGBW1</b> - 3000K</p> <p><b>RGBW2</b> - 3000K 4in1</p>	<p><b>LP0</b> - 128 LM / 1.5W FT / 90+CRI</p> <p><b>LP1</b> - 160 LM / 1.5W FT / 90+CRI</p> <p><b>LP2</b> - 255 LM / 3.0W FT / 90+CRI</p> <p><b>LP3</b> - 308 LM / 4.5W FT / 90+CRI</p> <p><b>LP4</b> - 400 LM / 5.8W FT / 90+CRI</p> <p><b>LHP</b> - 700 LM / 7.0W FT / 95+CRI</p> <p><b>Note:</b> Not applicable for Warmdim Tunable White &amp; RGB color temperatures</p>	<p><b>HW3</b> - Hardwire 3 FT</p> <p><b>HW6</b> - Hardwire 6 FT</p> <p><b>HW9</b> - Hardwire 9 FT</p> <p><b>HWX</b> - Hardwire custom FT</p> <p><b>NO</b> - No lead</p>	<p><b>I</b> - IP22 indoor dry location</p> <p><b>O</b> - IP68 wet/damp location</p> <p><b>Note:</b> IP68 not available with motion sensor option.</p>	<p><b>A</b> - Non-dimming</p> <p><b>B</b> - ELV dimming 120V AC</p> <p><b>C</b> - ELV dimming 120/277 VAC**</p> <p><b>D</b> - 0/10V dimming 120/277 VAC</p> <p><b>E</b> - Non-dimming DC plug in</p> <p><b>F</b> - DMX</p> <p><b>G</b> - Lutron - HI-LUME PREMIER 0,1% Eco System 24V/96W</p> <p><b>I</b> - Casambi CBU-A2D-0/10V-DALI-Bluetooth 100/277 VAC</p> <p><b>J</b> - Casambi CBU-PWM4-4CH-Bluetooth 100/277 VAC</p> <p><b>K</b> - Casambi CBU-TED-CV-Trail edge dim-Bluetooth 120 VAC</p> <p><b>NO</b> - No driver</p>	<p>*The light output is provided in lumens per foot, for a CCT of 4200K and a clear lens. Please refer to the optics page for CCT and translucency conversion factors.</p> <p>** Only available in 96W - 24V Driver</p> <div style="border: 1px solid black; padding: 5px; display: inline-block;"> <p>TITLE</p> <p><b>24</b></p> <p>COMPONENTS</p> </div>
COLOR TEMPERATURE CCT	LUMEN PACKAGE	LEAD IN LEAD OUT	USAGE	POWER SUPPLY/CONTROL	

# 1400 PROFILE

1000 Series



## Cross-section dimensions:

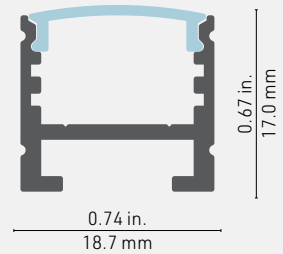

## SAY HELLO TO VERSATILITY!

In addition to offering even lighting, the 1400 allows beam adjustment<sup>1</sup> as well as a considerably larger choice of installation options<sup>2</sup>. This profile also offers a wide variety of installation, **from fixed to suspended mounting**.

(1) With an aluminum heatsink rail insert installed at different positions. (2) More than 500 configurations are possible!

### FEATURES

- The support rail offers the largest range of installation and assembly.
- Designed to give a uniform light without hot spots with an opal or prime lens.
- Custom length by sections of 2 to 240 inches (6m).
- Application guide for 10mm (3/8-inch) LED engine or less.
- Made of ALCOA 6063-T5 aluminum alloy increasing heat dissipation.
- Its use increases the lifetime of your LED engine.
- Compatible with multiple installation accessories (over 40 options).
- Designed to meet North American woodworking standards.

### OPTIONS



### LED ENGINE COMPATIBILITY

IP22: Compatible with LED engines up to **14mm** wide.

IP68: Compatible with LED engines up to **10mm** wide.

### LINEAR WEIGHT











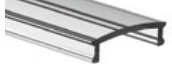











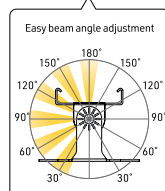

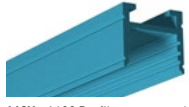









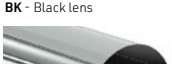

0.154 lbs/ft, 0.229 kg/m (without lens or insert)



















# 1400 Profile ordering sheet

# 1000 Series

1000

PROFILE	LENSES	MOUNTING HARDWARE	CANOPY	MOTION SENSORS*	LENGTH
 <p>1400 - 1400 Profile, alu</p>	 <p>CL - Clear lens</p>	 <p>FL - Flat bracket</p>	<p>NOTE: Only available with SUS bracket (suspension)</p>  <p>Remote driver canopy plate See Appendix 2 on page 158 CR0 - Alu CR1 - Black CR2 - White</p>	 <p>SEN1 - 30 sec. Embedded</p>	<p>Custom length by sections of 2 to 240 inches (6m).</p>
 <p>1401 - 1400 Profile, black</p>	 <p>SP - Spread lens</p>	 <p>45 - 45° Corner bracket</p>	 <p>Integrated driver in canopy See Appendix 2 on page 158 CI0 - Alu CI1 - Black CI2 - White</p>	 <p>SEN2 - 30 sec. Outside extrusion</p>	
 <p>1402 - 1400 Profile, white</p>	 <p>OX - Optiflex lens</p>	 <p>SW - Swivel bracket 180°</p>	 <p>Easy beam angle adjustment</p>	 <p>SEN3 - 4 min. Embedded</p>	
 <p>140X - 1400 Profile, custom color IMPORTANT: Give RAL color No See Appendix 1 on page 158</p>	 <p>OP - Opal lens</p>	 <p>PH - Phantom bracket</p>		 <p>Integrated driver &amp; suspension kit See Appendix 2 on page 158 CIK0 - Alu CIK1 - Black CIK2 - White</p>	 <p>SEN4 - 4 min. Outside extrusion</p>
 <p>RAL NUMBER</p>	 <p>PR - Prime lens</p>	 <p>MG - Magnetic kit</p>	<p>NO - No canopy</p> 	 <p>SEN5 - Intergrated proximity hand motion sensor</p>	
	 <p>BK - Black lens</p>	 <p>WSB - Surface 2-side bracket</p>		<p>NO - No sensor</p> 	
	 <p>FO - Focus lens</p>	 <p>SWS - Surface 1-side bracket</p>	<p>*NOTES</p> <p>All motion sensors: - Max 36W/12V or 72W/24V - Can only be used with non-dimmable power supplies</p>		
	 <p>OX3D - Square 3D, Optiflex</p>	 <p>AWS - Surface 90° bracket</p>			
	 <p>OP3D - Square 3D, Opal</p>	 <p>W45 - Surface 45° bracket</p>			
	 <p>SIL - Silens Serie 1000</p>	 <p>SUS - 1400 suspension kit</p>			
	<p>NO - No lens</p> 	<p>NO - No mounting hardware</p> 			

COLOR TEMPERATURE	LUMEN PACKAGE*	LEAD IN/OUT	USAGE	POWER SUPPLY/CONTROL	*NOTES
 24 - 2400K  27 - 2700K  30 - 3000K  35 - 3500K  42 - 4200K  53 - 5300K (LHP only)  62 - 6200K (LP only)  WD1 - WarmDim 14W  WD2 - WarmDim 17W  TW1 - Tunable White 11W  TW2 - Tunable White 19W  RGB1 - RGB 14W  RGB2 - RGB 19W  RGBW1 - 3000K  RGBW2 - 3000K 4in1	<p>LP0 - 128 LM / 1.5W FT / 90+CRI</p> <p>LP1 - 160 LM / 1.5W FT / 90+CRI</p> <p>LP2 - 255 LM / 3.0W FT / 90+CRI</p> <p>LP3 - 308 LM / 4.5W FT / 90+CRI</p> <p>LP4 - 400 LM / 5.8W FT / 90+CRI</p> <p>LHP - 700 LM / 7.0W FT / 95+CRI</p> <p>Note: Not applicable for Warmdim Tunable White &amp; RGB color temperatures</p>	<p>HW3 - Hardwire 3 FT</p> <p>HW6 - Hardwire 6 FT</p> <p>HW9 - Hardwire 9 FT</p> <p>HWX - Hardwire custom FT</p> <p>DC3 - DC plug 3 FT</p> <p>DC6 - DC plug 6 FT</p> <p>DC9 - DC plug 9 FT</p> <p>DCX - DC plug custom FT</p> <p>NO - No lead</p>	<p>I - IP22 indoor dry location</p> <p>O - IP68 wet/damp location</p> <p>Note: IP68 not available with motion sensor option.</p>	<p>A - Non-dimming</p> <p>B - ELV dimming 120V AC</p> <p>C - ELV dimming 120/277 VAC**</p> <p>D - 0/10V dimming 120/277 VAC</p> <p>E - Non-dimming DC plug in</p> <p>F - DMX</p> <p>G - Lutron - HI-LUME PREMIER 0,1% Eco System 24V/96W</p> <p>I - Casambi CBU-A2D-0/10V-DALI-Bluetooth 100/277 VAC</p> <p>J - Casambi CBU-PWM4-4CH-Bluetooth 100/277 VAC</p> <p>K - Casambi CBU-TED-CV-Trail edge dim-Bluetooth 120 VAC</p> <p>NO - No driver</p>	<p>*The light output is provided in lumens per foot, for a CCT of 4200K and a clear lens. Please refer to the optics page for CCT and translucency conversion factors.</p> <p>** Only available in 96W - 24V Driver</p> 

# 1450 PROFILE - REGULAR LED ENGINE

1000 Series



Cross-section dimensions:

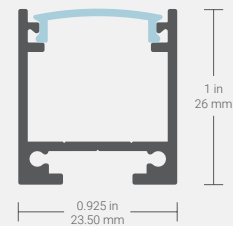

## SAY HELLO TO VERSATILITY VERSION 2.0!

This profile is the biggest in size from our 1000 series line of product. It **has been specially designed for outdoor use** and can house all the different IP68 lumen Packages we offer. With a new sliding lens design, this profile offers a wide variety of installation, from fixed to suspended mounting.

### FEATURES

- The support rail offers a large range of installation and assembly both fixed and suspended.
- NEW slidable lens system.
- Designed to give a uniform light without hot spots with a prime lens.
- Custom length by sections of 2 to 240 inches (6m).
- Made of ALCOA 6063-T5 aluminum alloy increasing heat dissipation.
- Its use increases the lifetime of your LED engine.
- Designed to meet North American woodworking standards.

### OPTIONS



### LED ENGINE COMPATIBILITY













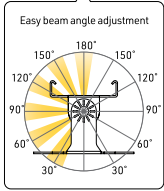











IP22: Compatible with LED engines up to **14mm** wide.

IP68: Compatible with LED engines up to **10mm** wide.

### LINEAR WEIGHT

0.23 lbs/ft, 0.35 kg/m (without lens or insert)



PROFILE	LENSES	MOUNTING HARDWARE	CANOPY	OPTION	LENGTH
 <p><b>1450</b> - Series 1400, alu</p>	 <p><b>PR</b> - Prime lens</p>	 <p><b>SW</b> - Swivel bracket 180°</p> 	<p><b>NOTE:</b> Only available with <b>SUS</b> bracket (suspension)</p>  <p><b>Remote driver canopy plate</b> See Appendix 2 on page 158 <b>CR0</b> - Alu <b>CR1</b> - Black <b>CR2</b> - White</p>	 <p><b>HER</b> - High efficiency reflector</p>  <p><b>NO</b> - No option</p>	<p>Custom length by sections of 2 to 240 inches (6m).</p>
 <p><b>1451</b> - Series 1400, black</p>	 <p><b>OP</b> - Opa lens</p>	 <p><b>PH</b> - Phantom bracket</p>	 <p><b>Integrated driver in canopy</b> See Appendix 2 on page 158 <b>CI0</b> - Alu <b>CI1</b> - Black <b>CI2</b> - White</p>		
 <p><b>1452</b> - Series 1400, white</p>	 <p><b>BK</b> - Black lens</p>	 <p><b>MG</b> - Magnetic kit</p>			
 <p><b>145X</b> - Series 1400, custom color</p> <p><b>IMPORTANT:</b> Give RAL color No See Appendix 1 on page 158</p>	 <p><b>FO</b> - Focus lens</p>	 <p><b>WSB</b> - Surface 2-side bracket</p>			
RAL NUMBER	 <p><b>PR3D</b> - Square 3D, Prime</p>  <p><b>NO</b> - No lens</p>	 <p><b>SWS</b> - Surface 1-side bracket</p>	 <p><b>Integrated driver &amp; suspension kit</b> See Appendix 2 on page 158 <b>CIK0</b> - Alu <b>CIK1</b> - Black <b>CIK2</b> - White</p>  <p><b>NO</b> - No canopy</p>		
		 <p><b>AWS</b> - Surface 90° bracket</p>			
		 <p><b>W45</b> - Surface 45° bracket</p>			
		 <p><b>SUS</b> - 1400 suspension kit</p>  <p><b>NO</b> - No mounting hardware</p>			
PROFILE	LENS	MOUNTING HARDWARE	CANOPY	OPTION	LENGTH

COLOR TEMPERATURE	LUMEN PACKAGE*	LEAD IN/OUT	USAGE	POWER SUPPLY/CONTROL	*NOTES
<p><b>24</b> - 2400K</p> <p><b>27</b> - 2700K</p> <p><b>30</b> - 3000K</p> <p><b>35</b> - 3500K</p> <p><b>42</b> - 4200K</p> <p><b>53</b> - 5300K (LHP only)</p> <p><b>62</b> - 6200K (LP only)</p> <p><b>WD1</b> - WarmDim 14W</p> <p><b>WD2</b> - WarmDim 17W</p> <p><b>TW1</b> - Tunable White 11W</p> <p><b>TW2</b> - Tunable White 19W</p> <p><b>RGB1</b> - RGB 14W</p> <p><b>RGB2</b> - RGB 19W</p> <p><b>RGBW1</b> - 3000K</p> <p><b>RGBW2</b> - 3000K 4in1</p>	<p><b>LP0</b> - 128 LM / 1.5W FT / 90+CRI</p> <p><b>LP1</b> - 160 LM / 1.5W FT / 90+CRI</p> <p><b>LP2</b> - 255 LM / 3.0W FT / 90+CRI</p> <p><b>LP3</b> - 308 LM / 4.5W FT / 90+CRI</p> <p><b>LP4</b> - 400 LM / 5.8W FT / 90+CRI</p> <p><b>LHP</b> - 700 LM / 7.0W FT / 95+CRI</p> <p><b>Note:</b> Not applicable for Warmdim Tunable White &amp; RGB color temperatures</p>	<p><b>HW3</b> - Hardwire 3 FT</p> <p><b>HW6</b> - Hardwire 6 FT</p> <p><b>HW9</b> - Hardwire 9 FT</p> <p><b>HWX</b> - Hardwire custom FT</p> <p><b>DC3</b> - DC plug 3 FT</p> <p><b>DC6</b> - DC plug 6 FT</p> <p><b>DC9</b> - DC plug 9 FT</p> <p><b>DCX</b> - DC plug custom FT</p> <p><b>NO</b> - No lead</p>	<p><b>1</b> - IP22 indoor dry location</p> <p><b>0</b> - IP68 wet/damp location</p> <p><b>Note:</b> IP68 not available with motion sensor option.</p>	<p><b>A</b> - Non-dimming</p> <p><b>B</b> - ELV dimming 120V AC</p> <p><b>C</b> - ELV dimming 120/277 VAC**</p> <p><b>D</b> - 0/10V dimming 120/277 VAC</p> <p><b>E</b> - Non-dimming DC plug in</p> <p><b>F</b> - DMX</p> <p><b>G</b> - Lutron - HI-LUME PREMIER 0,1% Eco System 24V/96W</p> <p><b>I</b> - Casambi CBU-A2D-0/10V-DALI-Bluetooth 100/277 VAC</p> <p><b>J</b> - Casambi CBU-PWM4-4CH-Bluetooth 100/277 VAC</p> <p><b>K</b> - Casambi CBU-TED-CV-Trail edge dim-Bluetooth 120 VAC</p> <p><b>NO</b> - No driver</p>	<p>*The light output is provided in lumens per foot, for a CCT of 4200K and a clear lens. Please refer to the optics page for CCT and translucency conversion factors.</p> <p>** Only available in 96W - 24V Driver</p> <div style="border: 1px solid black; padding: 5px; display: inline-block;"> <p>TITLE <b>24</b> COMPLIANCE</p> </div>
COLOR TEMPERATURE CCT	LUMEN PACKAGE	LEAD IN LEAD OUT	USAGE	POWER SUPPLY/CONTROL	

# 1450 PROFILE - LUXLINE 120V

1000 Series

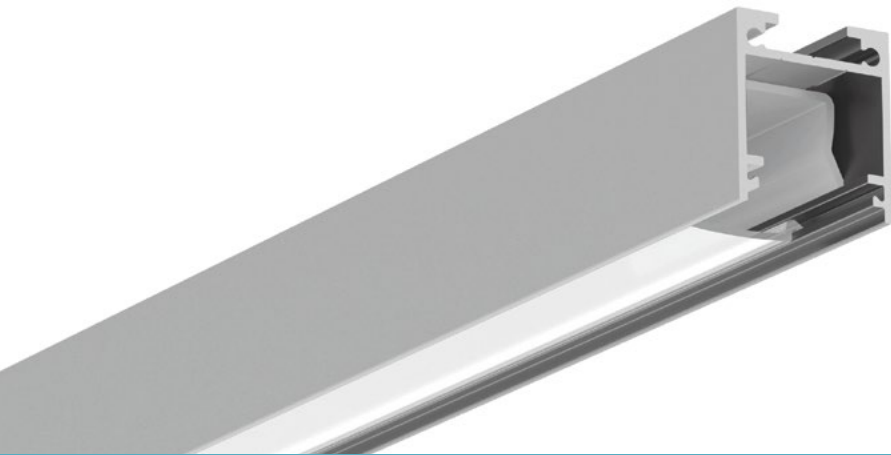

## Cross-section dimensions:

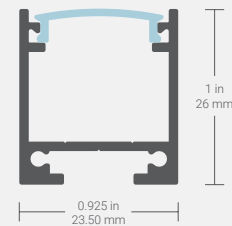

## SAY HELLO TO VERSATILITY VERSION 2.0!

This profile is the biggest in size from our 1000 series line of product. It has been specially designed to be used with our new **LuxLine** series of 120V LED engine tape. With a new sliding lens design, this profile offers a wide variety of installation, from fixed to suspended mounting.

### FEATURES

- The support rail offers a large range of installation and assembly both fixed and suspended.
- NEW slidable lens system.
- Designed to give a uniform light without hot spots with a prime lens.
- Custom length by sections of 2 to 240 inches (6m).
- Made of ALCOA 6063-T5 aluminum alloy increasing heat dissipation.
- Its use increases the lifetime of your LED engine.
- Designed to meet North American woodworking standards.

### OPTIONS



### LED ENGINE COMPATIBILITY

Compatible with LED engines up to **14mm** wide.

### LINEAR WEIGHT

0.23 lbs/ft, 0.35 kg/m (without lens or insert)

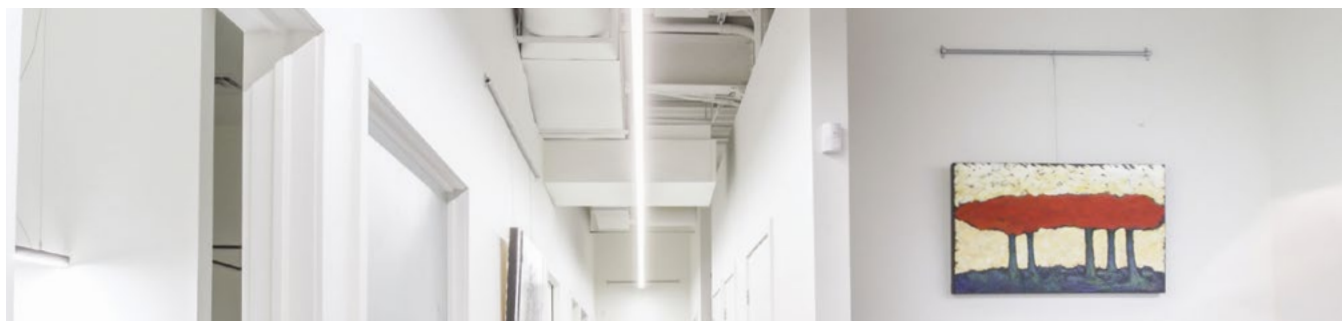

### LUXLINE FEATURES

- LumenTruss Driverless technology.
- Direct line voltage.
- Constant current IC providing uniform intensity over the entire run.
- Uses North American power plug with built-in fuse or hardwire.
- Order in lengths of 1 FT.
- 164 FT maximum run.
- Ultra high lumen output.
- Architectural grade.
- PVC coating (not recommended for direct sunlight).
- 3 year warranty.
- Life of 50,000 hours
- LED type: 3056
- WARNING: Do not cut AC plug.

### LUXLINE FEATURES



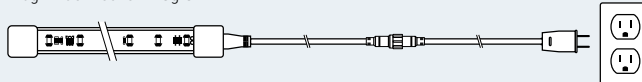









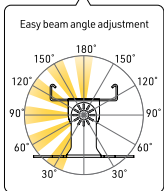









#### Plug-in Connection Diagram









#### Hardwire Connection Diagram

**With the NEW revolutionary hardwire connection with built-in fuse! Exclusive to LumenTruss.**



PROFILE	LENSES	MOUNTING HARDWARE	CANOPY	OPTION	LENGTH
 <b>1450</b> - Series 1400, alu	 <b>PR</b> - Prime lens	 <b>SW</b> - Swivel bracket 180° 	<p><b>NOTE:</b> Only available with <b>SUS</b> bracket (suspension)</p>  <b>Remote driver canopy plate</b> See Appendix 2 on page 158 <b>CR0</b> - Alu <b>CR1</b> - Black <b>CR2</b> - White	 <b>HER</b> - High efficiency reflector	Custom length by sections of 6 to 240 inches (6m).
 <b>1451</b> - Series 1400, black	 <b>OP</b> - Opal lens	 <b>PH</b> - Phantom bracket	 <b>NO</b> - No canopy	 <b>NO</b> - No option	
 <b>1452</b> - Series 1400, white	 <b>BK</b> - Black lens	 <b>MG</b> - Magnetic kit			
 <b>145X</b> - Series 1400, custom color <b>IMPORTANT:</b> Give RAL color No See Appendix 1 on page 158	 <b>FO</b> - Focus lens	 <b>WSB</b> - Surface 2-side bracket			
RAL NUMBER	 <b>PR3D</b> - Square 3D, Prime	 <b>SWS</b> - Surface 1-side bracket			
	 <b>NO</b> - No lens	 <b>AWS</b> - Surface 90° bracket			
		 <b>W45</b> - Surface 45° bracket			
		 <b>SUS</b> - 1400 suspension kit			
		 <b>NO</b> - No mounting hardware			
PROFILE	LENS	MOUNTING HARDWARE	CANOPY	OPTION	LENGTH

COLOR TEMPERATURE	LUMEN PACKAGE*	LEAD IN/OUT	JUMPER	USAGE	*NOTES
 24 - 2400K  27 - 2700K  30 - 3000K  35 - 3500K  42 - 4000K	<b>LUX</b> - 350 LM / 4.0W FT / 90+CRI	<b>PG</b> - Plug-in 47" <b>HW</b> - Hardwire 118"	<b>JP6</b> - Jumper 6" <b>JP12</b> - Jumper 12" <b>NO</b> - No jumper	<b>2</b> - IP65 indoor	The light output is provided in lumens per foot, for a CCT of 4200K and a clear lens. Please refer to the optics page for CCT and translucency conversion factors.  
COLOR TEMPERATURE CCT	LUMEN PACKAGE	LEAD IN    LEAD OUT	JUMPER    QTY	IP65	

# 1460 PROFILE

1000 Series

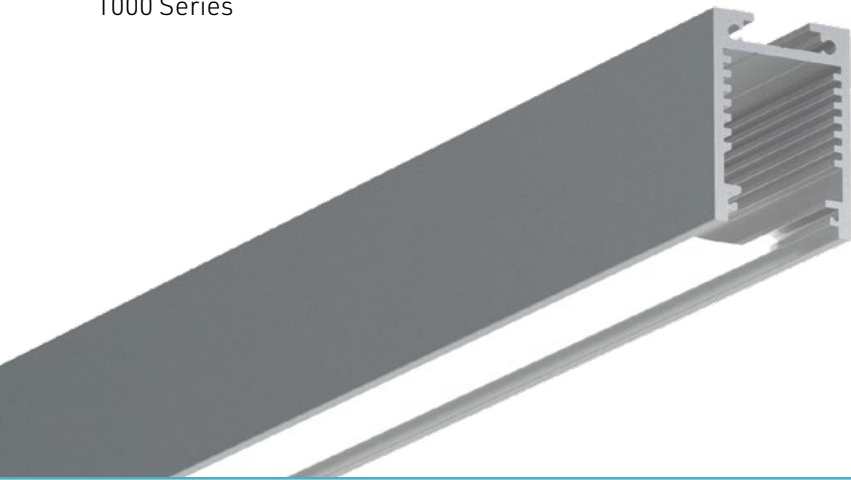

## Cross-section dimensions:

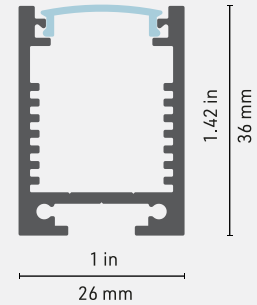

The 1460 can house all the different IP68 lumen Packages we offer. With a new sliding lens design, this profile offers a wide variety of installation, from fixed to suspended mounting. It also comes in a collection of trendy colors with the elegant aluminum finish. Its design is ideal for office, boutique and hotel applications or to enhance wall lighting.

## FEATURES

- Custom length by sections of 2 to 240 inches (6m).
- NEW slidable lens system.
- Designed to give a uniform light without hot spots with our prime lens.
- 2 colors to choose from in addition to the aluminum finish: black and white.
- 15 LED light sources to choose from 2400 K to 6200 K, including WarmDim, Tunable white, RGB and RGBW.
- Made of ALCOA 6063-T5 aluminum alloy for superior heat dissipation and increased LED light source life.
- Surface or suspended installation.

## OPTIONS



## LINEAR WEIGHT







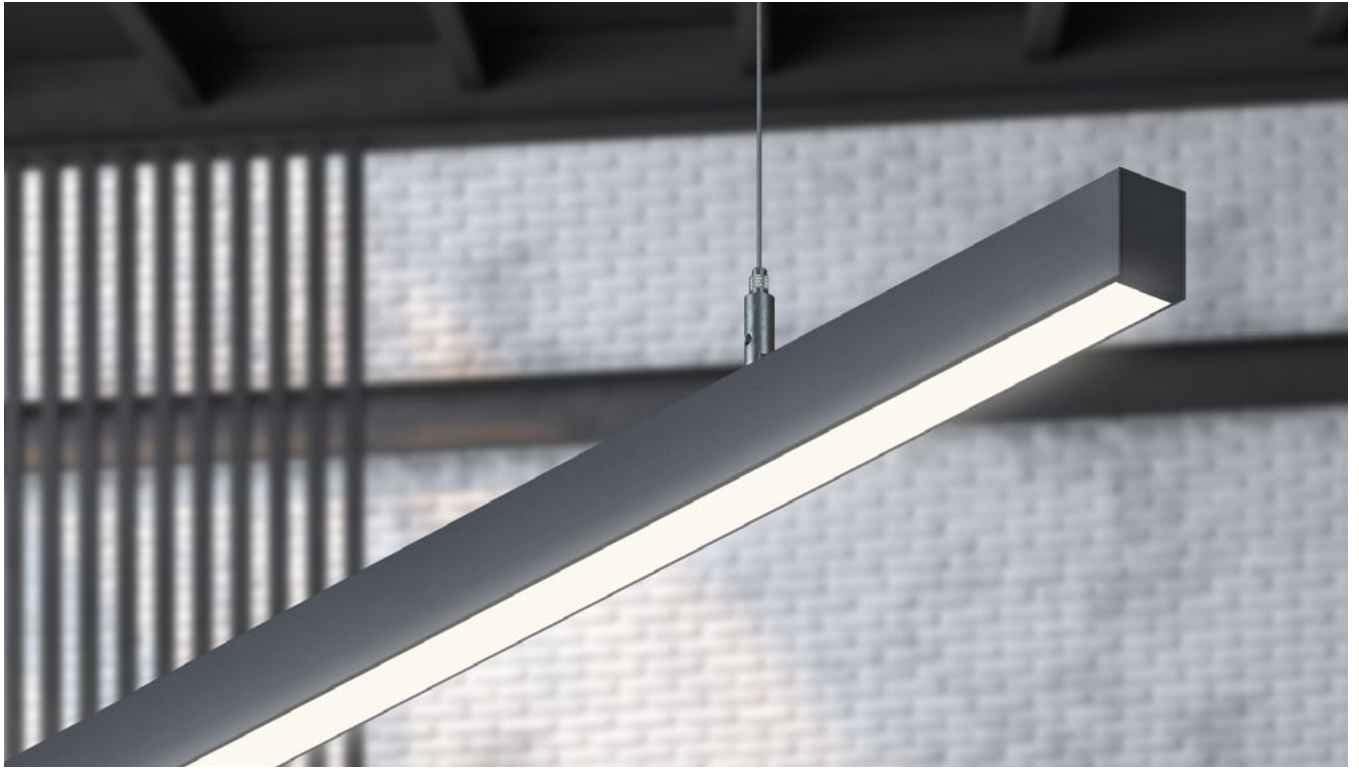















0.47 lbs/ft, 0.70 kg/m (without lens or insert)

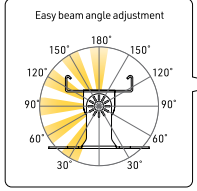





















PROFILE	LENSES	MOUNTING HARDWARE	CANOPY	OPTION	LENGTH
 <p><b>1460</b> - Series 1400, alu</p>	 <p><b>PR</b> - Prime lens</p>	 <p><b>PH</b> - Phantom bracket</p>	<p><b>NOTE:</b> Only available with <b>SUS</b> bracket (suspension)</p>  <p><b>Remote driver canopy plate</b> See Appendix 2 on page 158 <b>CR0</b> - Alu <b>CR1</b> - Black <b>CR2</b> - White</p>	 <p><b>HER</b> - High efficiency reflector</p>	<p>Custom length by sections of 6 to 240 inches (6m).</p>
 <p><b>1461</b> - Series 1400, black</p>	 <p><b>BK</b> - Black lens</p>	 <p><b>MG</b> - Magnetic kit</p>	 <p><b>NO</b> - No option</p>		
 <p><b>1462</b> - Series 1400, white</p>	 <p><b>NO</b> - No lens</p>	 <p><b>WSB</b> - Surface 2-side bracket</p>	 <p><b>Integrated driver in canopy</b> See Appendix 2 on page 158 <b>CI0</b> - Alu <b>CI1</b> - Black <b>CI2</b> - White</p>		
 <p><b>146X</b> - Series 1400, custom color <b>IMPORTANT:</b> Give RAL color No See Appendix 1 on page 158</p>	 <p>Easy beam angle adjustment</p>	 <p><b>AWS</b> - Surface 90° bracket</p>	 <p><b>Integrated driver &amp; suspension kit</b> See Appendix 2 on page 158 <b>CIK0</b> - Alu <b>CIK1</b> - Black <b>CIK2</b> - White</p>		
RAL NUMBER		 <p><b>W45</b> - Surface 45° bracket</p>	 <p><b>SWI</b> - Interior Swivel bracket 180°</p>	 <p><b>NO</b> - No canopy</p>	
		 <p><b>SWE</b> - Exterior Swivel bracket kit</p>	 <p><b>SUS</b> - 1400 suspension kit</p>		
		 <p><b>NO</b> - No mounting hardware</p>			
PROFILE	LENS	MOUNTING HARDWARE	CANOPY	OPTION	LENGTH

COLOR TEMPERATURE	LUMEN PACKAGE*	LEAD IN/OUT	USAGE	POWER SUPPLY/CONTROL	*NOTES
<ul style="list-style-type: none"> <li> 24 - 2400K</li> <li> 27 - 2700K</li> <li> 30 - 3000K</li> <li> 35 - 3500K</li> <li> 42 - 4200K</li> <li> 53 - 5300K (LHP only)</li> <li> 62 - 6200K (LP only)</li> <li> <b>WD1</b> - WarmDim 14W</li> <li> <b>WD2</b> - WarmDim 17W</li> <li> <b>TW1</b> - Tunable White 11W</li> <li> <b>TW2</b> - Tunable White 19W</li> <li> <b>RGB1</b> - RGB 14W</li> <li> <b>RGB2</b> - RGB 19W</li> <li> <b>RGBW1</b> - 3000K</li> <li> <b>RGBW2</b> - 3000K 4in1</li> </ul>	<ul style="list-style-type: none"> <li><b>LP0</b> - 128 LM / 1.5W FT / 90+CRI</li> <li><b>LP1</b> - 160 LM / 1.5W FT / 90+CRI</li> <li><b>LP2</b> - 255 LM / 3.0W FT / 90+CRI</li> <li><b>LP3</b> - 308 LM / 4.5W FT / 90+CRI</li> <li><b>LP4</b> - 400 LM / 5.8W FT / 90+CRI</li> <li><b>LHP</b> - 700 LM / 7.0W FT / 95+CRI</li> </ul> <p><b>Note:</b> Not applicable for Warmdim Tunable White &amp; RGB color temperatures</p>	<ul style="list-style-type: none"> <li><b>HW3</b> - Hardwire 3 FT</li> <li><b>HW6</b> - Hardwire 6 FT</li> <li><b>HW9</b> - Hardwire 9 FT</li> <li><b>HWX</b> - Hardwire custom FT</li> <li><b>DC3</b> - DC plug 3 FT</li> <li><b>DC6</b> - DC plug 6 FT</li> <li><b>DC9</b> - DC plug 9 FT</li> <li><b>DCX</b> - DC plug custom FT</li> <li><b>NO</b> - No lead</li> </ul>	<ul style="list-style-type: none"> <li><b>1</b> - IP22 indoor dry location</li> <li><b>0</b> - IP68 wet/damp location</li> </ul> <p><b>Note:</b> IP68 not available with motion sensor option.</p>	<ul style="list-style-type: none"> <li><b>A</b> - Non-dimming</li> <li><b>B</b> - ELV dimming 120V AC</li> <li><b>C</b> - ELV dimming 120/277 VAC**</li> <li><b>D</b> - 0/10V dimming 120/277 VAC</li> <li><b>E</b> - Non-dimming DC plug in</li> <li><b>F</b> - DMX</li> <li><b>G</b> - Lutron - HI-LUME PREMIER 0,1% Eco System 24V/96W</li> <li><b>I</b> - Casambi CBU-A2D-0/10V-DALI-Bluetooth 100/277 VAC</li> <li><b>J</b> - Casambi CBU-PWM4-4CH-Bluetooth 100/277 VAC</li> <li><b>K</b> - Casambi CBU-TED-CV-Trail edge dim-Bluetooth 120 VAC</li> <li><b>NO</b> - No driver</li> </ul>	<p>*The light output is provided in lumens per foot, for a CCT of 4200K and a clear lens. Please refer to the optics page for CCT and translucency conversion factors.</p> <p>** Only available in 96W - 24V Driver</p> <div style="border: 1px solid black; padding: 5px; width: fit-content;"> <p>TITLE <b>24</b> COMPONENTS</p> </div>
COLOR TEMPERATURE CCT	LUMEN PACKAGE	LEAD IN LEAD OUT	USAGE	POWER SUPPLY/CONTROL	

# 1500 PROFILE

1000 Series



## Cross-section dimensions:

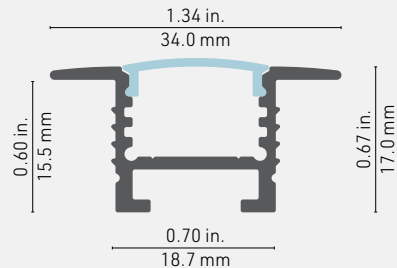

## RECESSED PROFILE WITH ADJUSTABLE BEAM!

The edge design of the 1500 profile harmonizes with your décor and allows for a very secure recessed installation and provides lighting without hot spots. Use with our spring brackets for a fast and easy installation.

### FEATURES

- The support rail offers the largest range of installation and assembly.
- Designed to give a uniform light without hot spots with an opal or prime lens.
- The edge allows recessed installation. To be installed in a 19mm (3/4-inch) groove.
- Custom length by sections of 2 to 240 inches (6m).
- Application guide for 10mm (3/8-inch) LED engine or less.
- Made of ALCOA 6063-T5 aluminum alloy increasing heat dissipation.
- Its use increases the lifetime of your LED engine.
- Designed to meet North American woodworking standards.

### OPTIONS



### LED ENGINE COMPATIBILITY















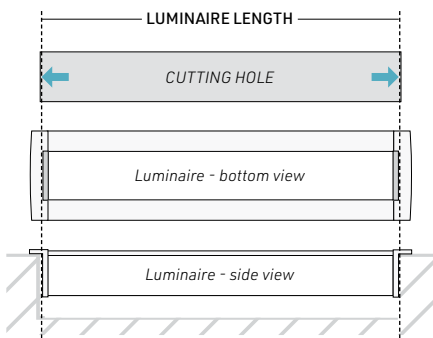



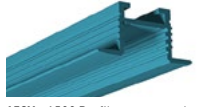

IP22: Compatible with LED engines up to **14mm** wide.

IP68: Compatible with LED engines up to **10mm** wide.

### LINEAR WEIGHT

0.192 lbs/ft, 0.286 kg/m (without lens or insert)

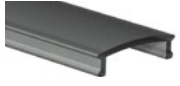

PROFILE	LENSES	MOUNTING HARDWARE	MOTION SENSORS*	LENGTH
 <p><b>1500</b> - 1500 Profile, alu</p>	 <p><b>CL</b> - Clear lens</p>	 <p><b>FL</b> - Flat bracket</p>	 <p><b>SEN1</b> - 30 sec. Embedded</p>	<p>Custom length by sections of 2 to 240 inches (6m).</p> <p><b>*NOTE:</b> Follow this diagram to calculate the correct length</p> 
 <p><b>1501</b> - 1500 Profile, alu</p>	 <p><b>SP</b> - Spread lens</p>	 <p><b>PH</b> - Phantom bracket</p>	 <p><b>SEN3</b> - 4 min. Embedded</p>	
 <p><b>1502</b> - 1500 Profile, white</p>	 <p><b>OX</b> - Optiflex lens</p>	 <p><b>MG</b> - Magnet kit</p>	 <p><b>SEN5</b> - Intergrated proximity hand motion sensor</p>	
 <p><b>150X</b> - 1500 Profile, custom color</p> <p><b>IMPORTANT:</b> Give RAL color No See Appendix 1 on page 158</p>	 <p><b>OP</b> - Opa lens</p>	 <p><b>SP</b> - Spring bracket</p>	 <p><b>NO</b> - No sensor</p>	
<p>RAL NUMBER</p>	 <p><b>BK</b> - Black lens</p>	 <p><b>NO</b> - No mounting hardware</p>	<p><b>*NOTES</b></p> <p>All motion sensors:                      - Max 36W/12V or 72W/24V                      - Can only be used with non-dimmable power supplies</p>	
	 <p><b>PR</b> - Prime lens</p>			
	 <p><b>SIL</b> - Silens Serie 1000</p>			
	 <p><b>NO</b> - No lens</p>			
PROFILE	LENS	MOUNTING HARDWARE	MOTION SENSOR	LENGTH

COLOR TEMPERATURE	LUMEN PACKAGE*	LEAD IN/OUT	USAGE	POWER SUPPLY/CONTROL	*NOTES
<p><b>24</b> - 2400K</p> <p><b>27</b> - 2700K</p> <p><b>30</b> - 3000K</p> <p><b>35</b> - 3500K</p> <p><b>42</b> - 4200K</p> <p><b>53</b> - 5300K (LHP only)</p> <p><b>62</b> - 6200K (LP only)</p> <p><b>WD1</b> - WarmDim 14W</p> <p><b>WD2</b> - WarmDim 17W</p> <p><b>TW1</b> - Tunable White 11W</p> <p><b>TW2</b> - Tunable White 19W</p> <p><b>RGB1</b> - RGB 14W</p> <p><b>RGB2</b> - RGB 19W</p> <p><b>RGBW1</b> - 3000K</p> <p><b>RGBW2</b> - 3000K 4in1</p>	<p><b>LP0</b> - 128 LM / 1.5W FT / 90+CRI</p> <p><b>LP1</b> - 160 LM / 1.5W FT / 90+CRI</p> <p><b>LP2</b> - 255 LM / 3.0W FT / 90+CRI</p> <p><b>LP3</b> - 308 LM / 4.5W FT / 90+CRI</p> <p><b>LP4</b> - 400 LM / 5.8W FT / 90+CRI</p> <p><b>LHP</b> - 700 LM / 7.0W FT / 95+CRI</p> <p><b>Note:</b> Not applicable for Warmdim Tunable White &amp; RGB color temperatures</p>	<p><b>HW3</b> - Hardwire 3 FT</p> <p><b>HW6</b> - Hardwire 6 FT</p> <p><b>HW9</b> - Hardwire 9 FT</p> <p><b>HWX</b> - Hardwire custom FT</p> <p><b>NO</b> - No lead</p>	<p><b>I</b> - IP22 indoor dry location</p> <p><b>O</b> - IP68 wet/damp location</p> <p><b>Note:</b> IP68 not available with motion sensor option.</p>	<p><b>A</b> - Non-dimming</p> <p><b>B</b> - ELV dimming 120V AC</p> <p><b>C</b> - ELV dimming 120/277 VAC**</p> <p><b>D</b> - 0/10V dimming 120/277 VAC</p> <p><b>E</b> - Non-dimming DC plug in</p> <p><b>F</b> - DMX</p> <p><b>G</b> - Lutron - HI-LUME PREMIER 0,1% Eco System 24V/96W</p> <p><b>I</b> - Casambi CBU-A2D-0/10V-DALI-Bluetooth 100/277 VAC</p> <p><b>J</b> - Casambi CBU-PWM4-4CH-Bluetooth 100/277 VAC</p> <p><b>K</b> - Casambi CBU-TED-CV-Trail edge dim-Bluetooth 120 VAC</p> <p><b>NO</b> - No driver</p>	<p>*The light output is provided in lumens per foot, for a CCT of 4200K and a clear lens. Please refer to the optics page for CCT and translucency conversion factors.</p> <p>** Only available in 96W - 24V Driver</p> <div style="border: 1px solid black; padding: 5px; display: inline-block;"> <p>TITLE</p> <p><b>24</b></p> <p>COMPONENTS</p> </div>
COLOR TEMPERATURE CCT	LUMEN PACKAGE	LEAD IN LEAD OUT	USAGE	POWER SUPPLY/CONTROL	

# 1580 OPTILUX PRO PROFILE

1000 Series



## Cross-section dimensions:

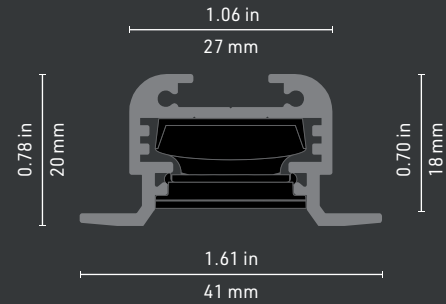

The edge design of the 1580 Optilux Pro profile harmonizes with your décor and allows for a very secure recessed installation. Use with our spring brackets for a fast and easy installation.

**A high-tech gem:** What makes the 1580 Optilux Pro Profile so innovative? Its lens incorporates an LED light source with a CRI of 95+, allowing you to direct the light exactly where you want it with exceptional quality and color rendition. Even better, its anti-reflective technology offers unparalleled visual comfort. Another innovation exclusive to LumenTruss™!

## FEATURES

- Length of light source in 6.5 in (16 cm) increments only
- CRI 95+ with PCB: black or white
- Choice of 4 color temperatures (2700 K, 3000 K, 3500 K et 4000 K)
- 2 beam angles: 30° × 30° (336 lm/ft) or 10° × 45° (345 lm/ft)
- Anti-reflective technology reducing eye fatigue
- Also available in a black finish
- Made of ALCOA 6063-T5 aluminum alloy for superior heat dissipation and increased LED light source life
- Rated life of up to 50,000 hours
- Indoor use, 24 V

## OPTIONS



## LINEAR WEIGHT



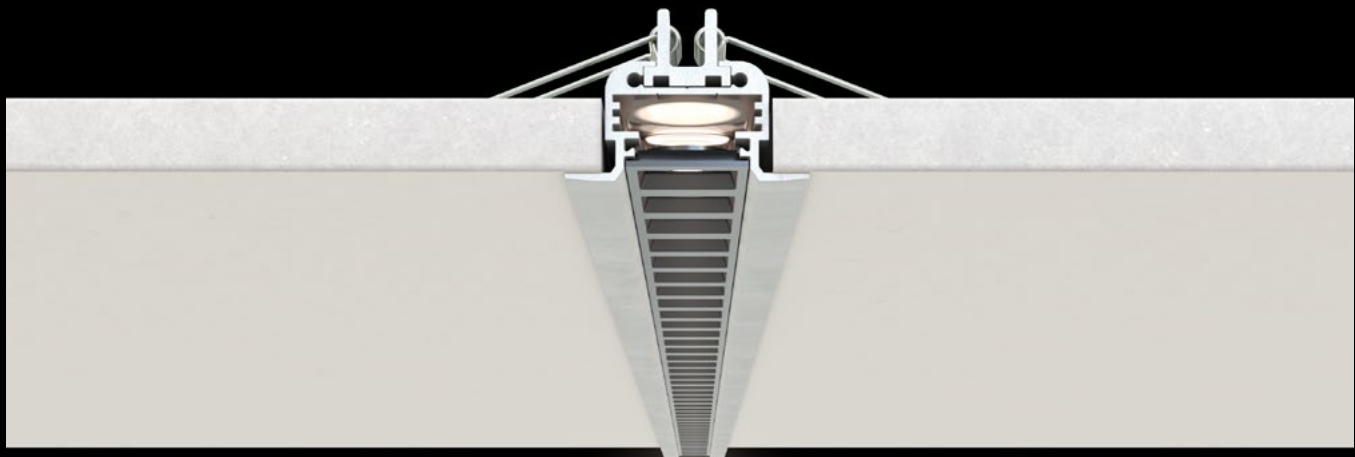



0.28 lbs/ft, 0.42 kg/m (without lens or insert)









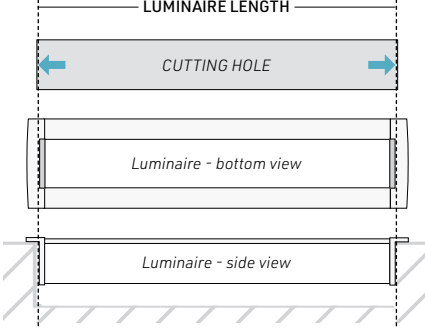



PROFILE	LENSES	MOUNTING HARDWARE	LENGTH
 <p>1580 - 1580 Profile, alu</p>	 <p>OPT1 - Optilux Black</p>	 <p>SP - Spring bracket</p>	<p>Choose prespecified length</p> <ul style="list-style-type: none"> <li>7 - 7"</li> <li>13 - 13.5625"</li> <li>20 - 20.1250"</li> <li>26 - 26.6875"</li> <li>33 - 33.25"</li> <li>39 - 39.8125"</li> <li>46 - 46.3750"</li> <li>53 - 52.9375"</li> <li>59 - 59.5"</li> <li>66 - 66.0625"</li> <li>72 - 72.6250"</li> <li>79 - 79.1875"</li> <li>85 - 85.75"</li> <li>92 - 92.3125"</li> </ul>
 <p>1581 - 1580 Profile, black</p>	 <p>OPT2 - Optilux white</p>	 <p>NO - No mounting hardware</p>	
	 <p>OPT3 - Optilux Gold</p>		
			
PROFILE	LENS	MOUNTING HARDWARE	LENGTH

COLOR TEMPERATURE	LUMEN PACKAGE/BEAM ANGLE*	LEAD IN	USAGE	POWER SUPPLY/CONTROL	*NOTES
<ul style="list-style-type: none"> <li> 27 - 2700K</li> <li> 30 - 3000K</li> <li> 35 - 3500K</li> <li> 40 - 4000K</li> </ul>	<p>OP1 - 336 LM / 7.0W FT / 95+CRI 30x30 Smooth spot</p> <p>OP2 - 345 LM / 7.0W FT / 95+CRI 10x45 Asymmetric</p>	<p>HW3 - Hardwire 3 FT</p> <p>HW6 - Hardwire 6 FT</p> <p>HW9 - Hardwire 9 FT</p> <p>HWX - Hardwire custom FT</p>	<p>I - IP22 indoor dry location</p>	<p>A - Non-dimming</p> <p>B - ELV dimming 120V AC</p> <p>C - ELV dimming 120/277 VAC**</p> <p>D - 0/10V dimming 120/277 VAC</p> <p>F - DMX</p> <p>G - Lutron - HI-LUME PREMIER 0,1% Eco System 24V/96W</p> <p>I - Casambi CBU-A2D-0/10V- DALI-Bluetooth 100/277 VAC</p> <p>J - Casambi CBU-PWM4-4CH- Bluetooth 100/277 VAC</p> <p>K - Casambi CBU-TED-CV-Trail edge dim-Bluetooth 120 VAC</p> <p>NO - No driver</p>	<p>*The light output is provided in lumens per foot, for a CCT of 4000K and a clear lens. Please refer to the optics page for CCT and translucency conversion factors.</p> <p>** Only available in 96W - 24V Driver</p> <div style="border: 1px solid black; padding: 5px; text-align: center;"> <p>TITLE</p> <p><b>24</b></p> <p>1000</p> </div>
COLOR TEMPERATURE CCT	LUMEN PACKAGE/BEAM ANGLE	LEAD IN	USAGE	POWER SUPPLY/CONTROL	

# 1590 PRO OPTILUX PROFILE

1000 Series



## Cross-section dimensions:

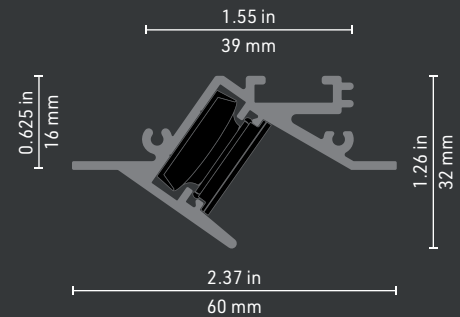

The 1590 Optilux Pro offers a direct and powerful light allowing you to focus the light wherever you want it. It can be focused on a work surface, to enhance textures or to achieve an indirect lighting with a wall-washing effect. The LED finish is available in a choice of three colors : black, white or gold. Designed for indoor use, it's ideal for the office, in a store or to enhance wall lighting. The 1590 is always built-in to provide you an efficient and effective light source. The lens is also anti-glare to provide you the best visual comfort. This light fixture is small, but very powerful and thanks to its many advantages, it will meet all your needs.

## FEATURES

- Length of light source in 6.5 in (16 cm) increments only
- CRI 95+ with PCB: black or white
- Choice of 4 color temperatures (2700 K, 3000 K, 3500 K et 4000 K)
- 2 beam angles: 30° × 30° (336 lm/ft) or 10° × 45° (345 lm/ft)
- Anti-reflective technology reducing eye fatigue
- Also available in a black finish
- Made of ALCOA 6063-T5 aluminum alloy for superior heat dissipation and increased LED light source life
- Rated life of up to 50,000 hours
- Indoor use, 24 V

## OPTIONS







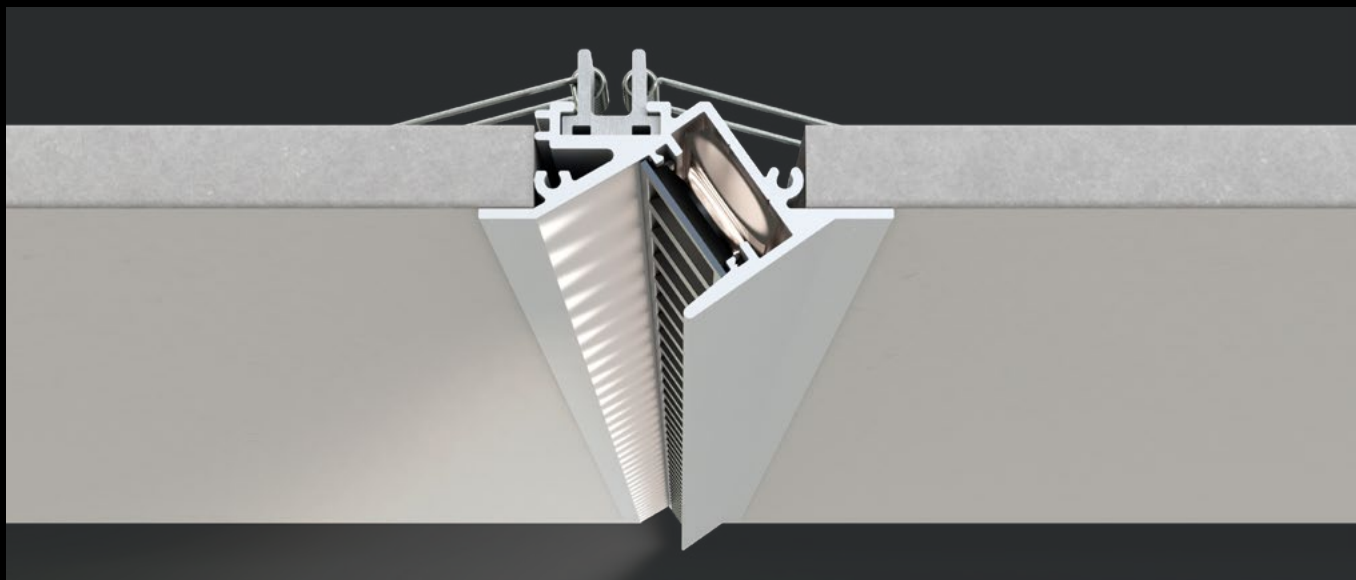

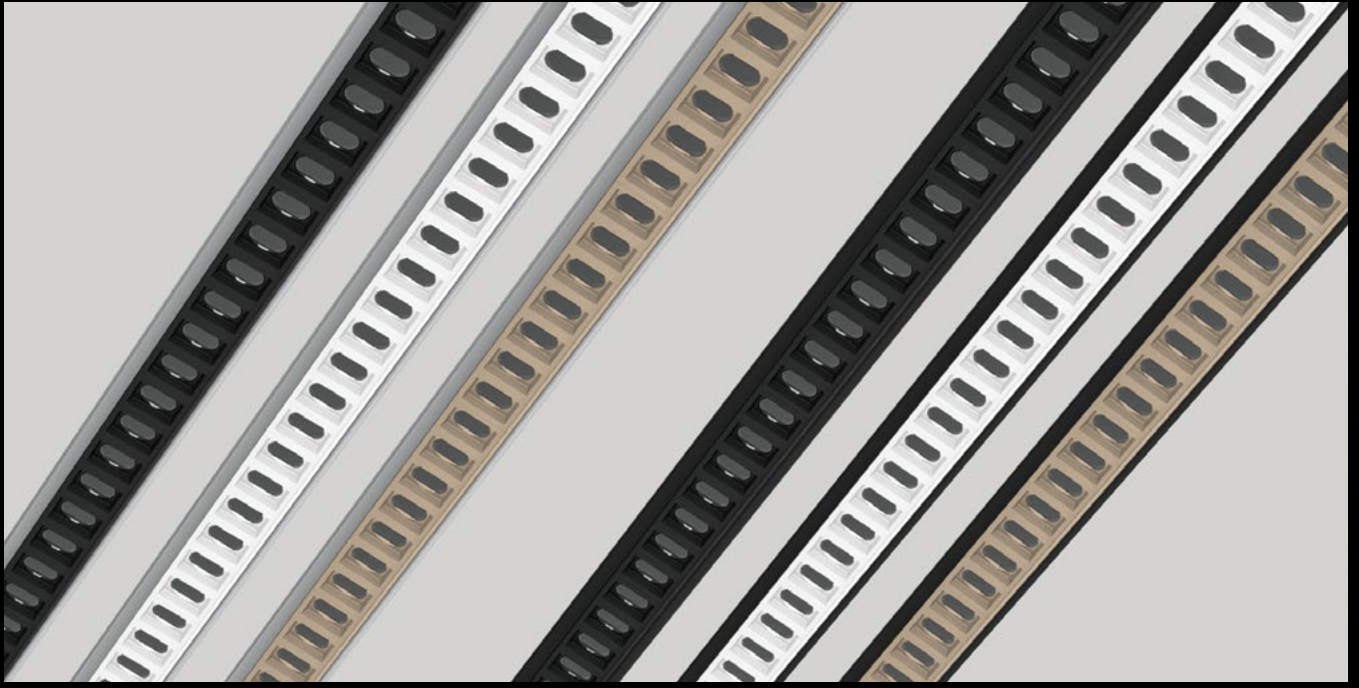

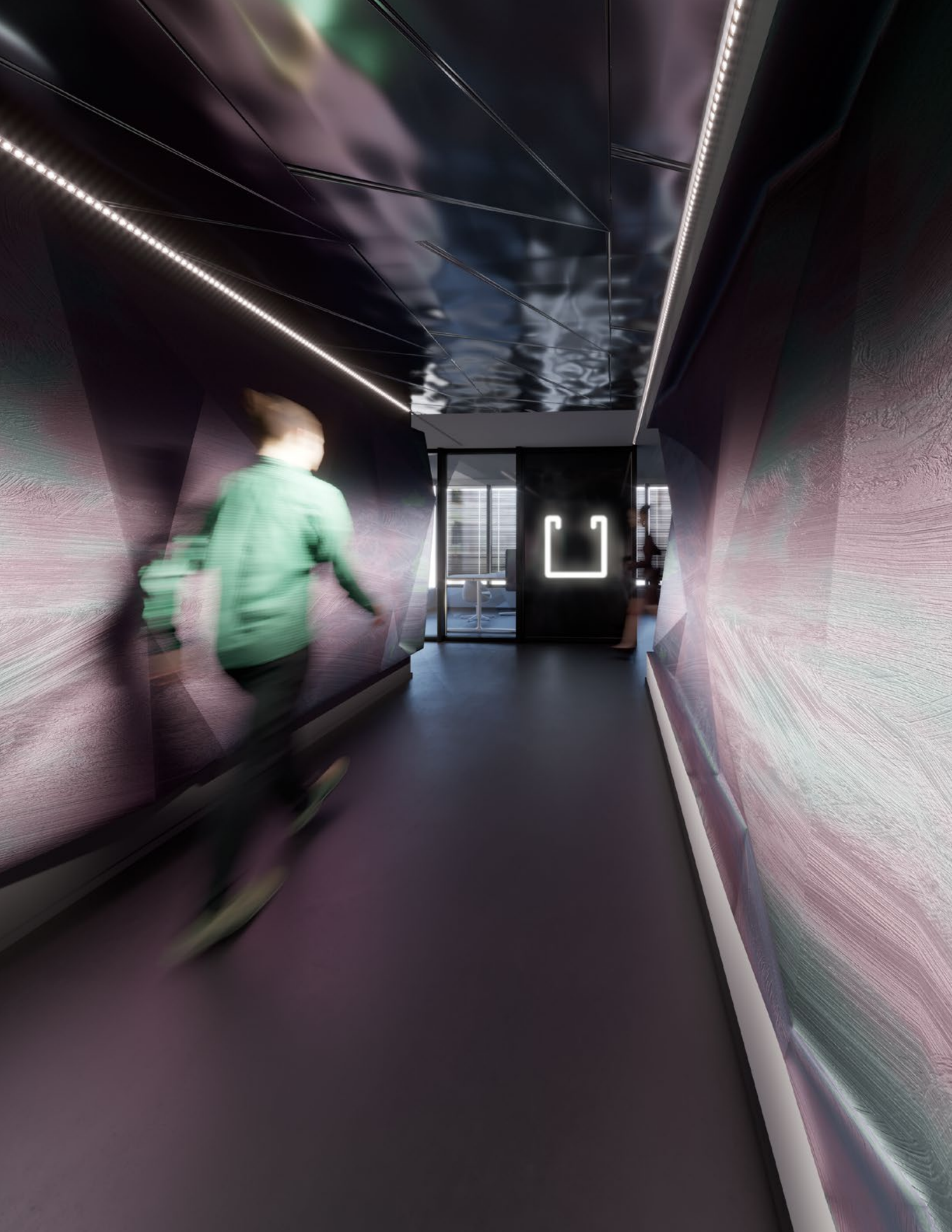
## LINEAR WEIGHT



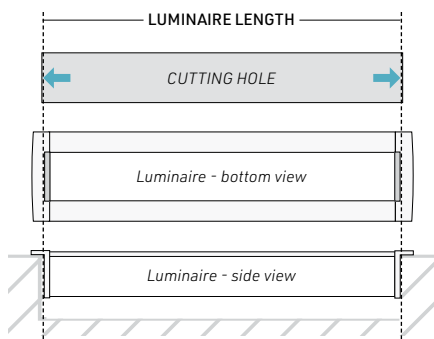

0.48 lbs/ft, 0.709 kg/m (without lens or insert)







PROFILE	LENSES	MOUNTING HARDWARE	LENGTH
 <p>1590 - 1590 Profile, alu</p>	 <p>OPT1 - Optilux Black</p>	 <p>SP - Spring bracket</p>	<p>Choose prespecified length</p> <p>7 - 7"                      13 - 13.5625"                      20 - 20.1250"                      26 - 26.6875"                      33 - 33.25"                      39 - 39.8125"                      46 - 46.3750"                      53 - 52.9375"                      59 - 59.5"                      66 - 66.0625"                      72 - 72.6250"                      79 - 79.1875"                      85 - 85.75"                      92 - 92.3125"</p> 
 <p>1591 - 1590 Profile, black</p>	 <p>OPT2 - Optilux white</p>	 <p>NO - No mounting hardware</p>	
	 <p>OPT3 - Optilux Gold</p>		
PROFILE	LENS	MOUNTING HARDWARE	LENGTH

COLOR TEMPERATURE	LUMEN PACKAGE/BEAM ANGLE*	LEAD IN	USAGE	POWER SUPPLY/CONTROL	*NOTES
 27 - 2700K  30 - 3000K  35 - 3500K  42 - 4000K	<p>OP1 - 336 LM / 7.0W FT / 95+CRI 30x30 Smooth spot</p> <p>OP2 - 345 LM / 7.0W FT / 95+CRI 10x45 Asymmetric</p>	<p>HW3 - Hardwire 3 FT</p> <p>HW6 - Hardwire 6 FT</p> <p>HW9 - Hardwire 9 FT</p> <p>HWX - Hardwire custom FT</p>	<p>I - IP22 indoor dry location</p>	<p>A - Non-dimming</p> <p>B - ELV dimming 120V AC</p> <p>C - ELV dimming 120/277 VAC**</p> <p>D - 0/10V dimming 120/277 VAC</p> <p>F - DMX</p> <p>G - Lutron - HI-LUME PREMIER 0,1% Eco System 24V/96W</p> <p>I - Casambi CBU-A2D-0/10V- DALI-Bluetooth 100/277 VAC</p> <p>J - Casambi CBU-PWM4-4CH- Bluetooth 100/277 VAC</p> <p>K - Casambi CBU-TED-CV-Trail edge dim-Bluetooth 120 VAC</p> <p>NO - No driver</p>	<p>*The light output is provided in lumens per foot, for a CCT of 4000K and a clear lens. Please refer to the optics page for CCT and translucency conversion factors.</p> <p>** Only available in 96W - 24V Driver</p> <div style="border: 1px solid black; padding: 5px; text-align: center;"> <p>TITLE</p> <p><b>24</b></p> <p>1000</p> </div>
COLOR TEMPERATURE CCT	LUMEN PACKAGE/BEAM ANGLE	LEAD IN	USAGE	POWER SUPPLY/CONTROL	

# 1650 PROFILE

1000 Series



Cross-section dimensions:

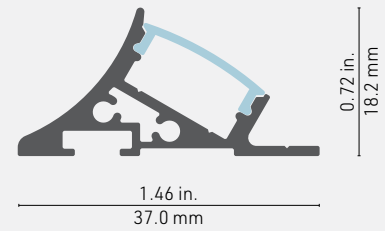

## PRACTICAL AND SLEEK

The 1650 profile is your best choice for **product display**. It offers lighting at a 30-degree angle, so you can cover all of the items on your shelves or racks and bring them centerstage. The smooth curved profile adds an extra accent in style. Use it with a clear lens to maximize the light output, or with an Optiflex or Opal lens for no hot spots from any angle.

### FEATURES

- Profile designed to light items on shelves and displays.
- Custom length by sections of 2 to 240 inches (6m).
- Application guide for 10mm (3/8-inch) LED engine or less.
- Made of ALCOA 6063-T5 aluminum alloy increasing heat dissipation.
- Its use increases the lifetime of your LED engine.
- Compatible with multiple installation accessories.
- Designed to meet North American woodworking standards.

### OPTIONS



### LED ENGINE COMPATIBILITY











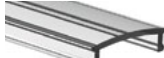

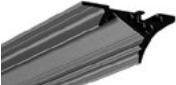





IP22: Compatible with LED engines up to **14mm** wide.

IP68: Compatible with LED engines up to **10mm** wide.

### LINEAR WEIGHT

0.232 lbs/ft, 0.345 kg/m (without lens)



PROFILE	LENSES	MOUNTING HARDWARE	MOTION SENSORS*	LENGTH
 <p><b>1650</b> - 1650 Profile, alu incl. 3M mounting tape</p>	 <p><b>CL</b> - Clear lens</p>	 <p><b>3M</b> - Mounting tape, double face</p>	 <p><b>SEN1</b> - 30 sec. Embedded</p>	<p>Custom length by sections of 2 to 240 inches (6m).</p>
 <p><b>1651</b> - 1650 Profile, black incl. 3M mounting tape</p>	 <p><b>SP</b> - Spread lens</p>	 <p><b>NO</b> - No mounting hardware</p>	 <p><b>SEN2</b> - 30 sec. Outside extrusion</p>	
 <p><b>1652</b> - 1650 Profile, white incl. 3M mounting tape</p>	 <p><b>OX</b> - Optiflex lens</p>		 <p><b>SEN3</b> - 4 min. Embedded</p>	
 <p><b>165X</b> - 1650 Profile, custom color incl. 3M mounting tape</p> <p><b>IMPORTANT:</b> Give RAL color No See Appendix 1 on page 158</p>	 <p><b>OP</b> - Opal lens</p>		 <p><b>SEN4</b> - 4 min. Outside extrusion</p>	
<p>RAL NUMBER</p>	 <p><b>PR</b> - Prime lens</p>		 <p><b>SEN5</b> - Intergrated proximity hand motion sensor</p>	
	 <p><b>BK</b> - Black lens</p>		 <p><b>NO</b> - No sensor</p>	
	 <p><b>SIL</b> - Silens Serie 1000</p>		<p><b>*NOTES</b></p> <p>All motion sensors: - Max 36W/12V or 72W/24V - Can only be used with non-dimmable power supplies</p>	
	 <p><b>NO</b> - No lens</p>			

PROFILE	LENS	MOUNTING HARDWARE	MOTION SENSOR	LENGTH
---------	------	-------------------	---------------	--------

**\*NOTE:** This profile has a direction. Please refer to the graphic on the right to figure out the sides of lead in, lead out wires.

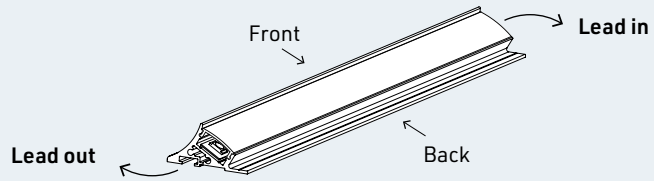

COLOR TEMPERATURE	LUMEN PACKAGE*	LEAD IN/OUT	USAGE	POWER SUPPLY/CONTROL	*NOTES
<p><b>24</b> - 2400K</p> <p><b>27</b> - 2700K</p> <p><b>30</b> - 3000K</p> <p><b>35</b> - 3500K</p> <p><b>42</b> - 4200K</p> <p><b>53</b> - 5300K (LHP only)</p> <p><b>62</b> - 6200K (LP only)</p> <p><b>WD1</b> - WarmDim 14W</p> <p><b>WD2</b> - WarmDim 17W</p> <p><b>TW1</b> - Tunable White 11W</p> <p><b>TW2</b> - Tunable White 19W</p> <p><b>RGB1</b> - RGB 14W</p> <p><b>RGB2</b> - RGB 19W</p> <p><b>RGBW1</b> - 3000K</p> <p><b>RGBW2</b> - 3000K 4in1</p>	<p><b>LP0</b> - 128 LM / 1.5W FT / 90+CRI</p> <p><b>LP1</b> - 160 LM / 1.5W FT / 90+CRI</p> <p><b>LP2</b> - 255 LM / 3.0W FT / 90+CRI</p> <p><b>LP3</b> - 308 LM / 4.5W FT / 90+CRI</p> <p><b>LP4</b> - 400 LM / 5.8W FT / 90+CRI</p> <p><b>LHP</b> - 700 LM / 7.0W FT / 95+CRI</p> <p><b>Note:</b> Not applicable for Warmdim Tunable White &amp; RGB color temperatures</p>	<p><b>HW3</b> - Hardwire 3 FT</p> <p><b>HW6</b> - Hardwire 6 FT</p> <p><b>HW9</b> - Hardwire 9 FT</p> <p><b>HWX</b> - Hardwire custom FT</p> <p><b>DC3</b> - DC plug 3 FT</p> <p><b>DC6</b> - DC plug 6 FT</p> <p><b>DC9</b> - DC plug 9 FT</p> <p><b>DCX</b> - DC plug custom FT</p> <p><b>NO</b> - No lead</p>	<p><b>I</b> - IP22 indoor dry location</p> <p><b>0</b> - IP68 wet/damp location</p> <p><b>Note:</b> IP68 not available with motion sensor option.</p>	<p><b>A</b> - Non-dimming</p> <p><b>B</b> - ELV dimming 120V AC</p> <p><b>C</b> - ELV dimming 120/277 VAC**</p> <p><b>D</b> - 0/10V dimming 120/277 VAC</p> <p><b>E</b> - Non-dimming DC plug in</p> <p><b>F</b> - DMX</p> <p><b>G</b> - Lutron - HI-LUME PREMIER 0,1% Eco System 24V/96W</p> <p><b>I</b> - Casambi CBU-A2D-0/10V-DALI-Bluetooth 100/277 VAC</p> <p><b>J</b> - Casambi CBU-PWM4-4CH-Bluetooth 100/277 VAC</p> <p><b>K</b> - Casambi CBU-TED-CV-Trail edge dim-Bluetooth 120 VAC</p> <p><b>NO</b> - No driver</p>	<p>*The light output is provided in lumens per foot, for a CCT of 4200K and a clear lens. Please refer to the optics page for CCT and translucency conversion factors.</p> <p>** Only available in 96W - 24V Driver</p> <div style="border: 1px solid black; padding: 5px; text-align: center;"> <p>TITLE</p> <p><b>24</b></p> <p>CONC. L&amp;S</p> </div>

COLOR TEMPERATURE CCT	LUMEN PACKAGE	LEAD IN	LEAD OUT	USAGE	POWER SUPPLY/CONTROL
-----------------------	---------------	---------	----------	-------	----------------------

# 1690 PROFILE

1000 Series



Cross-section dimensions:

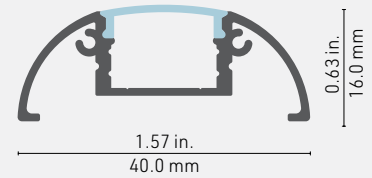

## GREAT FOR UNDER CABINET LIGHTING

A rounded profile especially **designed to conceal mounting hardware and wires**, the 1690 can serve well for under cabinet lighting, or on any other surface as a mural fixture.

### FEATURES

- Designed to give a uniform light without hot spots with an opal or prime lens.
- Custom length by sections of 2 to 240 inches (6m).
- Application guide for 10mm (3/8-inch) LED engine or less.
- Made of ALCOA 6063-T5 aluminum alloy increasing heat dissipation.
- Its use increases the lifetime of your LED engine.
- Compatible with multiple installation accessories.
- Designed to meet North American woodworking standards.

### OPTIONS



### LED ENGINE COMPATIBILITY

IP22: Compatible with LED engines up to **14mm** wide.



















IP68: Compatible with LED engines up to **10mm** wide.

### LINEAR WEIGHT

0.204 lbs/ft, 0.304 kg/m (without lens)





PROFILE	LENSES	MOUNTING HARDWARE	MOTION SENSORS*	LENGTH
 <p><b>1690</b> - 1690 Profile, alu</p>	 <p><b>CL</b> - Clear lens</p>	 <p><b>FL</b> - Flat bracket</p>	 <p><b>SEN1</b> - 30 sec. Embedded</p>	<p>Custom length by sections of 2 to 240 inches (6m).</p>
 <p><b>1691</b> - 1690 Profile, black</p>	 <p><b>SP</b> - Spread lens</p>	 <p><b>NO</b> - No mounting hardware</p>	 <p><b>SEN2</b> - 30 sec. Outside extrusion</p>	
 <p><b>1692</b> - 1690 Profile, white</p>	 <p><b>OX</b> - Optiflex lens</p>		 <p><b>SEN3</b> - 4 min. Embedded</p>	
 <p><b>169X</b> - 1690 Profile, custom color</p> <p><b>IMPORTANT:</b> Give RAL color No. See Appendix 1 on page 158</p>	 <p><b>OP</b> - Opal lens</p>		 <p><b>SEN4</b> - 4 min. Outside extrusion</p>	
<p>RAL NUMBER</p>	 <p><b>BK</b> - Black lens</p>		 <p><b>SEN5</b> - Intergrated proximity hand motion sensor</p>	
	 <p><b>SIL</b> - Silens Serie 1000</p>		 <p><b>NO</b> - No sensor</p>	
	 <p><b>NO</b> - No lens</p>		<p><b>*NOTES</b></p> <p>All motion sensors:                      - Max 36W/12V or 72W/24V                      - Can only be used with non-dimmable power supplies</p>	
PROFILE	LENS	MOUNTING HARDWARE	MOTION SENSOR	LENGTH

COLOR TEMPERATURE	LUMEN PACKAGE*	LEAD IN/OUT	USAGE	POWER SUPPLY/CONTROL	*NOTES
<p><b>24</b> - 2400K</p> <p><b>27</b> - 2700K</p> <p><b>30</b> - 3000K</p> <p><b>35</b> - 3500K</p> <p><b>42</b> - 4200K</p> <p><b>53</b> - 5300K (LHP only)</p> <p><b>62</b> - 6200K (LP only)</p> <p><b>WD1</b> - WarmDim 14W</p> <p><b>WD2</b> - WarmDim 17W</p> <p><b>TW1</b> - Tunable White 11W</p> <p><b>TW2</b> - Tunable White 19W</p> <p><b>RGB1</b> - RGB 14W</p> <p><b>RGB2</b> - RGB 19W</p> <p><b>RGBW1</b> - 3000K</p> <p><b>RGBW2</b> - 3000K 4in1</p>	<p><b>LP0</b> - 128 LM / 1.5W FT / 90+CRI</p> <p><b>LP1</b> - 160 LM / 1.5W FT / 90+CRI</p> <p><b>LP2</b> - 255 LM / 3.0W FT / 90+CRI</p> <p><b>LP3</b> - 308 LM / 4.5W FT / 90+CRI</p> <p><b>LP4</b> - 400 LM / 5.8W FT / 90+CRI</p> <p><b>LHP</b> - 700 LM / 7.0W FT / 95+CRI</p> <p><b>Note:</b> Not applicable for Warmdim Tunable White &amp; RGB color temperatures</p>	<p><b>HW3</b> - Hardwire 3 FT</p> <p><b>HW6</b> - Hardwire 6 FT</p> <p><b>HW9</b> - Hardwire 9 FT</p> <p><b>HWX</b> - Hardwire custom FT</p> <p><b>DC3</b> - DC plug 3 FT</p> <p><b>DC6</b> - DC plug 6 FT</p> <p><b>DC9</b> - DC plug 9 FT</p> <p><b>DCX</b> - DC plug custom FT</p> <p><b>NO</b> - No lead</p>	<p><b>I</b> - IP22 indoor dry location</p> <p><b>O</b> - IP68 wet/damp location</p> <p><b>Note:</b> IP68 not available with motion sensor option.</p>	<p><b>A</b> - Non-dimming</p> <p><b>B</b> - ELV dimming 120V AC</p> <p><b>C</b> - ELV dimming 120/277 VAC**</p> <p><b>D</b> - 0/10V dimming 120/277 VAC</p> <p><b>E</b> - Non-dimming DC plug in</p> <p><b>F</b> - DMX</p> <p><b>G</b> - Lutron - HI-LUME PREMIER 0,1% Eco System 24V/96W</p> <p><b>I</b> - Casambi CBU-A2D-0/10V-DALI-Bluetooth 100/277 VAC</p> <p><b>J</b> - Casambi CBU-PWM4-4CH-Bluetooth 100/277 VAC</p> <p><b>K</b> - Casambi CBU-TED-CV-Trail edge dim-Bluetooth 120 VAC</p> <p><b>NO</b> - No driver</p>	<p>*The light output is provided in lumens per foot, for a CCT of 4200K and a clear lens. Please refer to the optics page for CCT and translucency conversion factors.</p> <p>** Only available in 96W - 24V Driver</p> <div style="border: 1px solid black; padding: 5px; text-align: center;"> <p>TITLE</p> <p><b>24</b></p> <p>COMPONENTS</p> </div>
COLOR TEMPERATURE CCT	LUMEN PACKAGE	LEAD IN LEAD OUT	USAGE	POWER SUPPLY/CONTROL	

# 1800 PROFILE

1000 Series



## Cross-section dimensions:

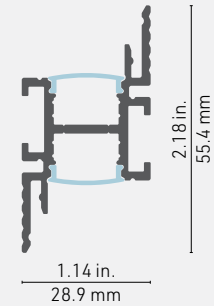

## EASIEST BIDIRECTIONAL LIGHT WASHING EVER

Here is a solution for the **easiest bidirectional light washing** ever. Whether illuminating art from behind the frame, adding a halo around a panel, lighting a cove or a vanity mirror from the perimeter, the 1800 profile will do a rock-solid job, fine-tuned to your liking, while staying, well, "behind the curtains."

### FEATURES

- An axially-symmetrical double profile accepting 2 light sources, projecting the light laterally in both directions.
- Developed for a concealed installation between two parallel surfaces.
- The protruding edges allow for a solid attachment to most surfaces and/or panels, permanently via your choice of standard hardware, or easily removable when using our standard WB wall mounting brackets with a lightweight front panel.
- Designed to give a uniform light without hot spots with an opal or prime lens.
- Custom length by sections of 2 to 240 inches (6m).
- Application guide for 10mm (3/8-inch) LED engine or less.
- Made of ALCOA 6063-T5 aluminum alloy, increasing heat dissipation and the lifetime of your LED engine.
- Designed to meet North American woodworking standards.

### OPTIONS



### LED ENGINE COMPATIBILITY





















IP22: Compatible with LED engines up to **14mm** wide.















IP68: Compatible with LED engines up to **10mm** wide.

### LINEAR WEIGHT

0.483 lbs/ft, 0.719 kg/m (without lens)



PROFILE	INSIDE LENS	OUTSIDE LENS	MOUNTING HARDWARE	LENGTH
 <p>1800 - 1800 Profile, alu</p>	 <p>CL - Clear lens</p>	 <p>CL - Clear lens</p>	 <p>WB - 6" wall mount bracket, alu</p>	<p>Custom length by sections of 2 to 240 inches (6m).</p>
	 <p>SP - Spread lens</p>	 <p>SP - Spread lens</p>		
	 <p>OX - Optiflex lens</p>	 <p>OX - Optiflex lens</p>		
	 <p>OP - Opal lens</p>	 <p>OP - Opal lens</p>		
	 <p>PR - Prime lens</p>	 <p>PR - Prime lens</p>		
	 <p>BK - Black lens</p>	 <p>BK - Black lens</p>		
	 <p>FO - Focus lens</p>	 <p>FO - Focus lens</p>		
	 <p>SIL - Silens Serie 1000</p>	 <p>SIL - Silens Serie 1000</p>		
	 <p>NO - No lens</p>	 <p>NO - No lens</p>		
<b>1800</b>			<b>WB</b>	
PROFILE	LENS INSIDE	LENS OUTSIDE	MOUNTING HARDWARE	LENGTH

COLOR TEMPERATURE	LUMEN PACKAGE*	LEAD IN/OUT	USAGE	POWER SUPPLY/CONTROL	*NOTES
<ul style="list-style-type: none"> <li> 24 - 2400K</li> <li> 27 - 2700K</li> <li> 30 - 3000K</li> <li> 35 - 3500K</li> <li> 42 - 4200K</li> <li> 53 - 5300K (LHP only)</li> <li> 62 - 6200K (LP only)</li> <li> WD1 - WarmDim 14W</li> <li> WD2 - WarmDim 17W</li> <li> TW1 - Tunable White 11W</li> <li> TW2 - Tunable White 19W</li> <li> RGB1 - RGB 14W</li> <li> RGB2 - RGB 19W</li> <li> RGBW1 - 3000K</li> <li> RGBW2 - 3000K 4in1</li> </ul>	<ul style="list-style-type: none"> <li>LP0 - 128 LM / 1.5W FT / 90+CRI</li> <li>LP1 - 160 LM / 1.5W FT / 90+CRI</li> <li>LP2 - 255 LM / 3.0W FT / 90+CRI</li> <li>LP3 - 308 LM / 4.5W FT / 90+CRI</li> <li>LP4 - 400 LM / 5.8W FT / 90+CRI</li> <li>LHP - 700 LM / 7.0W FT / 95+CRI</li> </ul> <p><b>Note:</b> Not applicable for Warmdim Tunable White &amp; RGB color temperatures</p>	<ul style="list-style-type: none"> <li>HW3 - Hardwire 3 FT</li> <li>HW6 - Hardwire 6 FT</li> <li>HW9 - Hardwire 9 FT</li> <li>HWX - Hardwire custom FT</li> <li>DC3 - DC plug 3 FT</li> <li>DC6 - DC plug 6 FT</li> <li>DC9 - DC plug 9 FT</li> <li>DCX - DC plug custom FT</li> <li>NO - No lead</li> </ul>	<ul style="list-style-type: none"> <li>I - IP22 indoor dry location</li> <li>O - IP68 wet/damp location</li> </ul> <p><b>Note:</b> IP68 not available with motion sensor option.</p>	<ul style="list-style-type: none"> <li>A - Non-dimming</li> <li>B - ELV dimming 120V AC</li> <li>C - ELV dimming 120/277 VAC**</li> <li>D - 0/10V dimming 120/277 VAC</li> <li>E - Non-dimming DC plug in</li> <li>F - DMX</li> <li>G - Lutron - HI-LUME PREMIER 0,1% Eco System 24V/96W</li> <li>I - Casambi CBU-A2D-0/10V-DALI-Bluetooth 100/277 VAC</li> <li>J - Casambi CBU-PWM4-4CH-Bluetooth 100/277 VAC</li> <li>K - Casambi CBU-TED-CV-Trail edge dim-Bluetooth 120 VAC</li> <li>NO - No driver</li> </ul>	<p>*The light output is provided in lumens per foot, for a CCT of 4200K and a clear lens. Please refer to the optics page for CCT and translucency conversion factors.</p> <p>** Only available in 96W - 24V Driver</p> <div style="border: 1px solid black; padding: 5px; display: inline-block;"> <p>TITLE <b>24</b> COMPLIANCE</p> </div>
COLOR TEMPERATURE CCT	LUMEN PACKAGE	LEAD IN    LEAD OUT	USAGE	POWER SUPPLY/CONTROL	



**2000 SERIES**





# 2000 PROFILE

2000 Series



Cross-section dimensions:

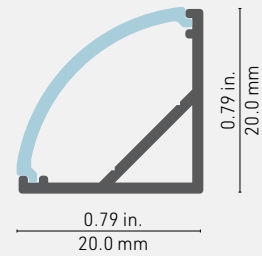

## WELL FOCUSED ON THE TASK!

Offering lighting without hot spots at a **45-degree** angle from a corner, the 2000 Series excels at maximizing appeal of the products in POP stands, while maintaining a minimalist style.

### FEATURES

- Offers lighting with a beam oriented at 45 degrees.
- Designed to give a uniform light without hot spots with an opal or prime lens.
- Custom length by sections of 2 to 240 inches (6m).
- Application guide for 10mm (3/8-inch) LED engine or less.
- Made of ALCOA 6063-T5 aluminum alloy increasing heat dissipation.
- Its use increases the lifetime of your LED engine.
- Designed to meet North American woodworking standards.

### OPTIONS



### LED ENGINE COMPATIBILITY

IP22: Compatible with LED engines up to **14mm** wide.











IP68: Compatible with LED engines up to **10mm** wide.















### LINEAR WEIGHT

0.117 lbs/ft, 0.175 kg/m (without lens)



Boutique Exclucity - Project Manager: J. W. Design

PROFILE	LENSES	MOUNTING HARDWARE	LENGTH
 <p>2000 - 2000 Profile, alu</p>	 <p>CLR - Clear lens, round</p>	 <p>45 - 45° corner bracket</p>	<p>Custom length by sections of 2 to 240 inches (6m).</p>
	 <p>OXR - Optiflex lens, round</p>	 <p>3M - Mounting tape, double face</p>	
	 <p>OPR - Opal lens, round</p>	 <p>NO - No mounting hardware</p>	
	 <p>PRR - Prime lens, round</p>		
	 <p>OXS - Optiflex lens, square</p>		
	 <p>OPS - Opal lens, square</p>		
	 <p>NO - No lens</p>		
<b>2000</b>	LENS	MOUNTING HARDWARE	LENGTH

COLOR TEMPERATURE	LUMEN PACKAGE*	LEAD IN/OUT	USAGE	POWER SUPPLY/CONTROL	*NOTES
<ul style="list-style-type: none"> <li> 24 - 2400K</li> <li> 27 - 2700K</li> <li> 30 - 3000K</li> <li> 35 - 3500K</li> <li> 42 - 4200K</li> <li> 53 - 5300K (LHP only)</li> <li> 62 - 6200K (LP only)</li> <li> WD1 - WarmDim 14W</li> <li> WD2 - WarmDim 17W</li> <li> TW1 - Tunable White 11W</li> <li> TW2 - Tunable White 19W</li> <li> RGB1 - RGB 14W</li> <li> RGB2 - RGB 19W</li> <li> RGBW1 - 3000K</li> <li> RGBW2 - 3000K 4in1</li> </ul>	<ul style="list-style-type: none"> <li>LP0 - 128 LM / 1.5W FT / 90+CRI</li> <li>LP1 - 160 LM / 1.5W FT / 90+CRI</li> <li>LP2 - 255 LM / 3.0W FT / 90+CRI</li> <li>LP3 - 308 LM / 4.5W FT / 90+CRI</li> <li>LP4 - 400 LM / 5.8W FT / 90+CRI</li> <li>LHP - 700 LM / 7.0W FT / 95+CRI</li> </ul> <p><b>Note:</b> Not applicable for Warmdim Tunable White &amp; RGB color temperatures</p>	<ul style="list-style-type: none"> <li>HW3 - Hardwire 3 FT</li> <li>HW6 - Hardwire 6 FT</li> <li>HW9 - Hardwire 9 FT</li> <li>HWX - Hardwire custom FT</li> <li>DC3 - DC plug 3 FT</li> <li>DC6 - DC plug 6 FT</li> <li>DC9 - DC plug 9 FT</li> <li>DCX - DC plug custom FT</li> <li>NO - No lead</li> </ul>	<ul style="list-style-type: none"> <li>I - IP22 indoor dry location</li> <li>O - IP68 wet/damp location.</li> </ul>	<ul style="list-style-type: none"> <li>A - Non-dimming</li> <li>B - ELV dimming 120V AC</li> <li>C - ELV dimming 120/277 VAC**</li> <li>D - 0/10V dimming 120/277 VAC</li> <li>E - Non-dimming DC plug in</li> <li>F - DMX</li> <li>G - Lutron - HI-LUME PREMIER 0,1% Eco System 24V/96W</li> <li>I - Casambi CBU-A2D-0/10V-DALI-Bluetooth 100/277 VAC</li> <li>J - Casambi CBU-PWM4-4CH-Bluetooth 100/277 VAC</li> <li>K - Casambi CBU-TED-CV-Trail edge dim-Bluetooth 120 VAC</li> <li>NO - No driver</li> </ul>	<p>*The light output is provided in lumens per foot, for a CCT of 4200K and a clear lens. Please refer to the optics page for CCT and translucency conversion factors.</p> <p>** Only available in 96W - 24V Driver</p> <div style="border: 1px solid black; padding: 5px; width: fit-content;"> <p>TITLE <b>24</b> COMPONENTS</p> </div>
COLOR TEMPERATURE CCT	LUMEN PACKAGE	LEAD IN    LEAD OUT	USAGE	POWER SUPPLY/CONTROL	

# 2200 PROFILE

2000 Series



## Cross-section dimensions:

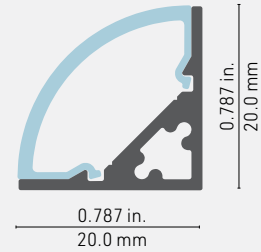

## WELL FOCUSED ON THE TASK!

Creating a visual impact has never been easier with our new 2200 profile. Offering lighting without hot spots at a 45-degree angle from a corner, this series excels at maximizing appeal of the products in POP stands while maintaining a minimalist style. This profile includes a long lens fitting system to maximize its long term durability.

For a no points light effect combine the 2200 profile with an LED engine (at least 120 leds / meter) and our Prime lens.

### FEATURES

- Offers lighting with a beam oriented at 45 degrees.
- Designed to give a uniform light without hot spots
- Custom length by sections of 2 to 192".
- Application guide for 10mm (3/8-inch) LED engine or less.
- Made of ALCOA 6063-T5 aluminum alloy increasing heat dissipation.
- Its use increases the lifetime of your LED engine.
- New enhance mechanical fit for the lens.

### OPTIONS



### LED ENGINE COMPATIBILITY

IP22: Compatible with LED engines up to **14mm** wide.

IP68: Compatible with LED engines up to **10mm** wide.

### LINEAR WEIGHT



0.139 lbs/ft, 0.120 kg/m (without lens)



















PROFILE	LENSES	MOUNTING HARDWARE	LENGTH
 <p><b>2200</b> - 2200 Profile, alu</p>	 <p><b>PR</b> - Prime Lens</p>	 <p><b>45</b> - 45° corner bracket</p>	<p>Custom length by sections of 2 to 192 inches (5m).</p>
 <p><b>2201</b> - 2200 Profile, black</p>	 <p><b>NO</b> - No Lens</p>	 <p><b>3M</b> - Mounting tape, double face</p>	
 <p><b>220X</b> - 2200 Profile, custom color</p> <p><b>IMPORTANT:</b> Give RAL color No See Appendix 1 on page 158</p>	 <p><b>NO</b> - No mounting hardware</p>		

RAL NUMBER

PROFILE      LENS      MOUNTING HARDWARE      LENGTH

COLOR TEMPERATURE	LUMEN PACKAGE*	LEAD IN/OUT	USAGE	POWER SUPPLY/CONTROL	*NOTES
 <b>24</b> - 2400K  <b>27</b> - 2700K  <b>30</b> - 3000K  <b>35</b> - 3500K  <b>42</b> - 4200K  <b>53</b> - 5300K (LHP only)  <b>62</b> - 6200K (LP only)  <b>WD</b> - WarmDim  <b>RGB</b> - RGB  <b>RGBW</b> - RGBW	<p><b>LP0</b> - 128 LM / 1.5W FT / 90+CRI</p> <p><b>LP1</b> - 160 LM / 1.5W FT / 90+CRI</p> <p><b>LP2</b> - 255 LM / 3.0W FT / 90+CRI</p> <p><b>LP3</b> - 308 LM / 4.5W FT / 90+CRI</p> <p><b>LP4</b> - 400 LM / 5.8W FT / 90+CRI</p> <p><b>LHP</b> - 700 LM / 7.0W FT / 95+CRI</p> <p><b>Note:</b> Not applicable for WarmDim &amp; RGB color temperatures</p>	<p><b>HW3</b> - Hardwire 3 FT</p> <p><b>HW6</b> - Hardwire 6 FT</p> <p><b>HW9</b> - Hardwire 9 FT</p> <p><b>HWX</b> - Hardwire custom FT</p> <p><b>DC3</b> - DC plug 3 FT</p> <p><b>DC6</b> - DC plug 6 FT</p> <p><b>DC9</b> - DC plug 9 FT</p> <p><b>DCX</b> - DC plug custom FT</p> <p><b>NO</b> - No lead</p>	<p><b>I</b> - IP22 indoor dry location</p> <p><b>0</b> - IP68 wet/damp location</p> <p><b>Note:</b> WarmDim is only available in IP22.</p>	<p><b>A</b> - Non-dimming</p> <p><b>B</b> - ELV dimming 120V AC</p> <p><b>C</b> - ELV dimming 120/277V AC**</p> <p><b>D</b> - 0/10V dimming 120/277V AC</p> <p><b>E</b> - Non-dimming DC plug in</p> <p><b>F</b> - DMX</p> <p><b>NO</b> - No driver</p>	<p>*The light output is provided in lumens per foot, for a CCT of 4200K and a clear lens. Please refer to the optics page for CCT and translucency conversion factors.</p> <p>** Only available in 96W - 24V Driver</p> 
COLOR TEMPERATURE CCT	LUMEN PACKAGE	LEAD IN      LEAD OUT	USAGE	POWER SUPPLY/CONTROL	

# 2400 PROFILE

2000 Series



Cross-section dimensions:

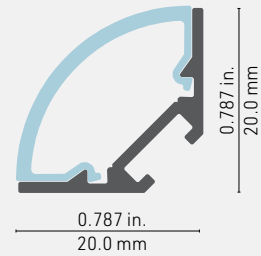

## WELL FOCUSED ON THE TASK!

Offering lighting without hot spots at a 45-degree angle from a corner, this series excels at maximizing appeal of the products in POP stands, while maintaining a minimalist style. This profile includes a long lens fitting system to maximize its long term durability.

With a type A mounting channel in the back, you can easily join multiple sections with a type A straight joiner or use it to pass and hide the wiring behind the profile.

### FEATURES

- Offers lighting with a beam oriented at 45 degrees.
- Designed to provide a uniform light without hot spots with our PRIME lens and an LED engine with 120 led/m density or more.
- Custom length in sections of 2 to 192".
- Application guide for 10mm (3/8-inch) LED engine or less.
- Made of ALCOA 6063-T5 aluminum alloy increasing heat dissipation.
- Its use increases the lifetime of your LED engine.
- Type A mounting channel in the back of the profile
- New enhanced mechanical fit for the lens.

### OPTIONS



### LED ENGINE COMPATIBILITY

IP22: Compatible with LED engines up to **14mm** wide.

IP68: Compatible with LED engines up to **10mm** wide.

### LINEAR WEIGHT

0.10 lbs/ft, 0.152 kg/m (without lens)

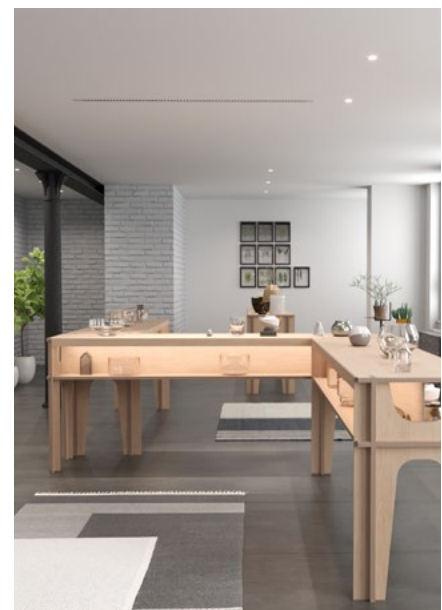











## INTELLIGENT DESIGN

A groove in the back of the extrusion is designed to conceal electrical wiring, giving the luminaire an even more aesthetic look.















PROFILE	LENSES	MOUNTING HARDWARE	LENGTH
 <p><b>2400</b> - 2400 Profile, alu</p>	 <p><b>PR</b> - Prime Lens</p>	 <p><b>45</b> - 45° corner bracket</p>	<p>Custom length by sections of 2 to 192 inches (5m).</p>
 <p><b>2401</b> - 2400 Profile, black</p>	 <p><b>NO</b> - No Lens</p>	 <p><b>3M</b> - Mounting tape, double face</p>	
 <p><b>240X</b> - 2400 Profile, custom color</p> <p><b>IMPORTANT:</b> Give RAL color No See Appendix 1 on page 158</p>	 <p><b>NO</b> - No mounting hardware</p>		

RAL NUMBER

PROFILE      LENS      MOUNTING HARDWARE      LENGTH

COLOR TEMPERATURE	LUMEN PACKAGE*	LEAD IN/OUT	USAGE	POWER SUPPLY/CONTROL	*NOTES
 <b>24</b> - 2400K  <b>27</b> - 2700K  <b>30</b> - 3000K  <b>35</b> - 3500K  <b>42</b> - 4200K  <b>53</b> - 5300K (LHP only)  <b>62</b> - 6200K (LP only)  <b>WD</b> - WarmDim  <b>RGB</b> - RGB  <b>RGBW</b> - RGBW	<p><b>LP0</b> - 128 LM / 1.5W FT / 90+CRI</p> <p><b>LP1</b> - 160 LM / 1.5W FT / 90+CRI</p> <p><b>LP2</b> - 255 LM / 3.0W FT / 90+CRI</p> <p><b>LP3</b> - 308 LM / 4.5W FT / 90+CRI</p> <p><b>LP4</b> - 400 LM / 5.8W FT / 90+CRI</p> <p><b>LHP</b> - 700 LM / 7.0W FT / 95+CRI</p> <p><b>Note:</b> Not applicable for WarmDim &amp; RGB color temperatures</p>	<p><b>HW3</b> - Hardwire 3 FT</p> <p><b>HW6</b> - Hardwire 6 FT</p> <p><b>HW9</b> - Hardwire 9 FT</p> <p><b>HWX</b> - Hardwire custom FT</p> <p><b>DC3</b> - DC plug 3 FT</p> <p><b>DC6</b> - DC plug 6 FT</p> <p><b>DC9</b> - DC plug 9 FT</p> <p><b>DCX</b> - DC plug custom FT</p> <p><b>NO</b> - No lead</p>	<p><b>I</b> - IP22 indoor dry location</p> <p><b>0</b> - IP68 wet/damp location</p> <p><b>Note:</b> WarmDim is only available in IP22.</p>	<p><b>A</b> - Non-dimming</p> <p><b>B</b> - ELV dimming 120V AC</p> <p><b>C</b> - ELV dimming 120/277V AC**</p> <p><b>D</b> - 0/10V dimming 120/277V AC</p> <p><b>E</b> - Non-dimming DC plug in</p> <p><b>F</b> - DMX</p> <p><b>NO</b> - No driver</p>	<p>*The light output is provided in lumens per foot, for a CCT of 4200K and a clear lens. Please refer to the optics page for CCT and translucency conversion factors.</p> <p>** Only available in 96W - 24V Driver</p> 
COLOR TEMPERATURE CCT	LUMEN PACKAGE	LEAD IN      LEAD OUT	USAGE	POWER SUPPLY/CONTROL	



# 3000 SERIES







# 3100 PROFILE

3000 Series

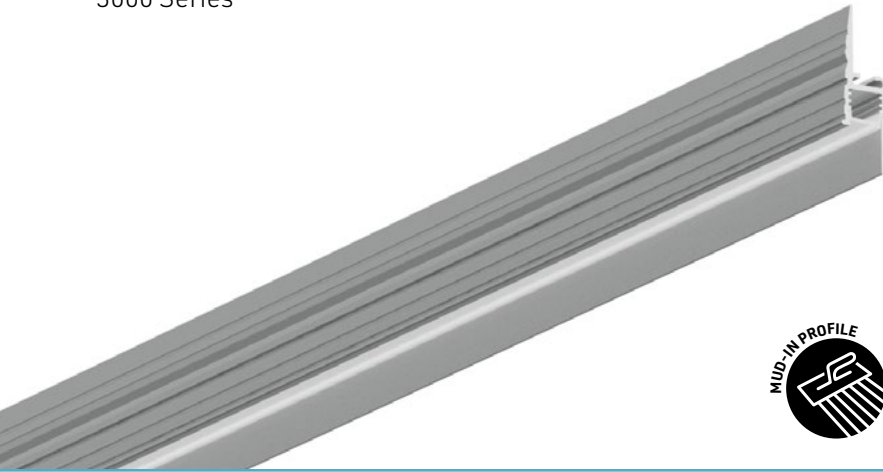

## Cross-section dimensions:

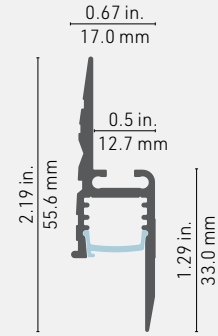

## REDEFINES CONTOUR LIGHTING!

Ideal for night lighting and dramatically enhancing the perimeter of a room, the new 3100 aluminum profile is recessed and provides uniform contour lighting, downward, at 90°. It fits perfectly with standard gypsum panels for a seamless finish. This wall application meets aesthetic and safety needs in areas with low levels or poor lighting. Perfect for lighting a corridor in a residence or a hotel!

### FEATURES

- Designed to be recessed and provide uniform contour lighting, downward, at 90 degrees. Indoor use for residential or commercial applications.
- Direct adjustment with standard 1/2 inch gypsum panels and with 5/8 inch gypsum panels.
- Impeccable finish thanks to the grooves that allow the profile to be leveled to the plasterboard using joint compound.
- Available in 96 inch (2.43 m) lengths for easy and accurate on-site installation.
- Equipped with a Prime lens for uniform illumination without light dots and optimal light diffusion.
- 8 mm LED light source: 4.8 W, 9.6 W, and 14.5 W, with 5 color temperatures (2400 K to 4200 K), also available in 10 mm width in 14.4 W-RGB.
- Designed to meet North American woodworking standards.

### OPTIONS



### LED ENGINE COMPATIBILITY





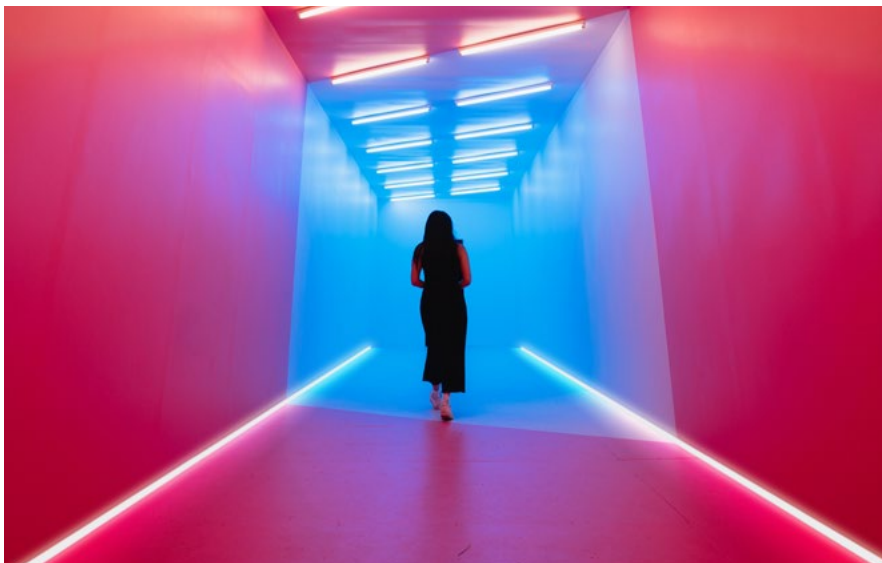

Compatible with LED engines up to **10mm** wide.

### LINEAR WEIGHT













0.330lbs/ft, 0.491kg/m (without lens)



PROFILE	LENGTH	LENSES
 <p>3100 QTY - Profile</p>	<p>Available in straight section of 8 feet (96 inches/2.4 m). *Cut on site</p>	 <p>PR - Prime lens</p>  <p>SIL - SiLens</p>
QUANTITY	X <b>96 INCHES</b> LENGTH	LENS

ENDCAPS		JOINERS			ACCESSORIES
 <p>3150 left endcap</p>	 <p>3150 right endcap</p>	 <p>Type A straight joiner</p>	 <p>Type A horz. 45°/135° joiner</p>	 <p>Type A horz. 90° joiner</p>	 <p>Drywall small head screw (x100)</p>
QUANTITY	QUANTITY	QUANTITY	QUANTITY	QUANTITY	QUANTITY

**LED engine will be assembled on site. See Appendix 3 on page 159 to see how to calculate total ordering length.**

COLOR TEMPERATURE	LUMEN PACKAGE*	LEAD IN/OUT	USAGE	POWER SUPPLY/CONTROL	LENGTH
<ul style="list-style-type: none"> <li> 24 - 2400K</li> <li> 27 - 2700K</li> <li> 30 - 3000K</li> <li> 35 - 3500K</li> <li> 42 - 4200K</li> <li> 53 - 5300K (LHP only)</li> <li> 62 - 6200K (LP only)</li> <li> WD1 - WarmDim 14W</li> <li> TW1 - Tunable White 11W</li> <li> TW2 - Tunable White 19W</li> <li> RGB1 - RGB 14W</li> <li> RGB2 - RGB 19W</li> </ul>	<p>LP0 - 128 LM / 1.5W FT / 90+CRI</p> <p>LP1 - 160 LM / 1.5W FT / 90+CRI</p> <p>LP2 - 255 LM / 3.0W FT / 90+CRI</p> <p>LP3 - 308 LM / 4.5W FT / 90+CRI</p> <p>LP4 - 400 LM / 5.8W FT / 90+CRI</p> <p>LHP - 700 LM / 7.0W FT / 95+CRI</p> <p><b>Note:</b> Not applicable for Warmdim, Tunable White and RGB color temperatures</p>	<p>HW3 - Hardwire 3 FT</p> <p>HW6 - Hardwire 6 FT</p> <p>HW9 - Hardwire 9 FT</p> <p>HWX - Hardwire custom FT</p> <p>NO - No lead</p>	<p>I - IP22 indoor dry location</p>	<p>A - Non-dimming</p> <p>B - ELV dimming 120V AC</p> <p>C - ELV dimming 120/277 VAC**</p> <p>D - 0/10V dimming 120/277 VAC</p> <p>E - Non-dimming DC plug in</p> <p>F - DMX</p> <p>G - Lutron - HI-LUME PREMIER 0,1% Eco System 24V/96W</p> <p>I - Casambi CBU-A2D-0/10V-DALI-Bluetooth 100/277 VAC</p> <p>J - Casambi CBU-PWM4-4CH-Bluetooth 100/277 VAC</p> <p>K - Casambi CBU-TED-CV-Trail edge dim-Bluetooth 120 VAC</p> <p>NO - No driver</p>	<p><b>Total length of LED engine in inches</b> - See Appendix 3 on how to calculate length.</p>
COLOR TEMPERATURE CCT	LUMEN PACKAGE	LEAD IN    LEAD OUT	USAGE	POWER SUPPLY/CONTROL	LED ENGINE LENGTH

\*NOTE: The light output is provided in lumens per foot, for a CCT of 4200K and a clear lens. Please refer to the optics page for CCT and translucency conversion factors. \*\* Only available in 96W - 24V Driver

# 3150 PROFILE

3000 Series

60%  
Longer  
reveal



## Cross-section dimensions:

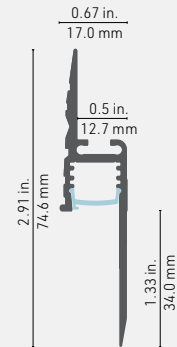

## NEW! CONTOUR LIGHTING AT ITS BEST!

The ultimate in profiles that disappear completely into the wall surface, the 3150 is designed to provide downward lighting, 90° angle lighting. With a longer inner section than the 3100, this profile provides a greater surface area for light reflection, which optimizes safety applications in areas with poor or deficient lighting. Choice of two high-end lenses to ensure optimal light diffusion: the PRIME, which is rigid, or the new SiLens in flexible silicone, which can be installed with the touch of a finger. A new feature: it can be used with all type A joiners to build a solid structure. This profile fits 1/2" and 5/8" gypsum panels for a seamless finish. Ideal for residential or commercial applications.

### FEATURES

- Available in 96 in (2.43 m) lengths for easy and accurate on-site installation
- Direct fit with standard 1/2" and 5/8" gypsum panels
- 60% longer reveal than the 3100 profile
- Impeccable finish thanks to the grooves that allow the profile to be levelled with joint compound
- Choice of high-end optics: PRIME lens or SiLens, made of flexible silicone, which can be installed with the touch of a finger
- LED light sources in 8 mm (1.5 W/ft, 2.93 W/ft, and 4.5 W/ft) with 7 colour temperatures (2400 K to 6200 K) and in 10 mm (4.4 W/ft & 5.9 W/ft RGB and 7.0 W/ft HOS)
- Application guide for light sources 10 mm (0.394") or less in IP22
- Indoor use

### OPTIONS



### LED ENGINE COMPATIBILITY

Compatible with LED engines up to **10mm** wide.

### LINEAR WEIGHT

0.3923lbs/ft, 583.81g/m (without lens)

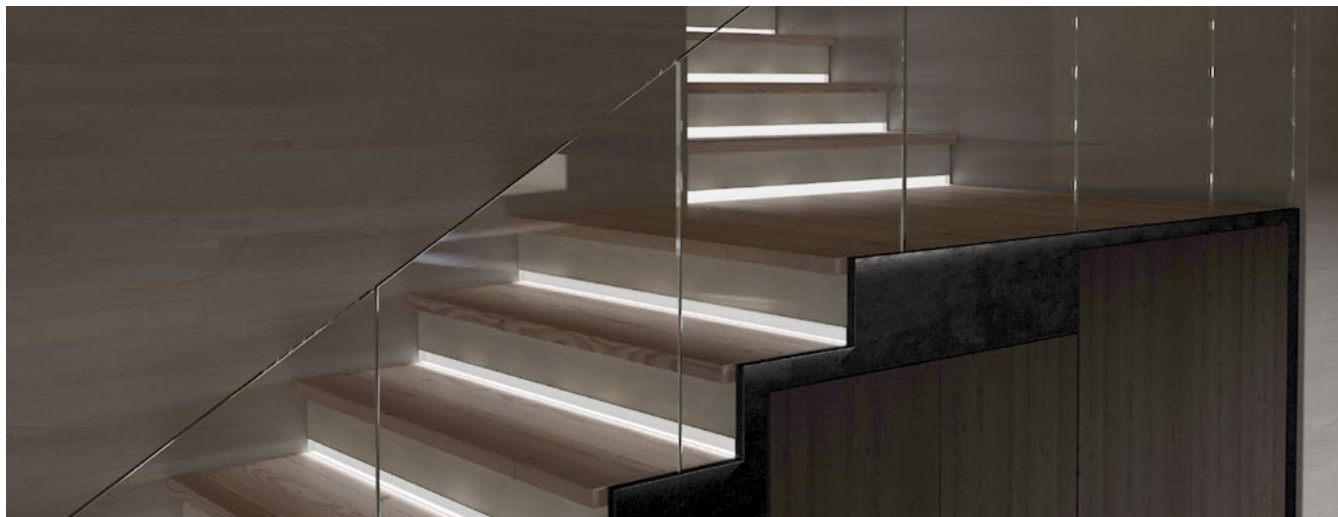





## NEW SMALL FLAT HEAD SCREW!



Our new small flat head screw fits perfectly into the V-groove of profile 3150 and other adapted profiles. This gypsum screw does not require the use of a milling cutter. Installation is faster and requires less drywall to finish, saving time and material.







### FEATURES

- Compatible with 3000 Series profiles and 8870 extrusion
- Head 35% smaller than standard gypsum screws
- Use with Robertson-tip screwdriver #2 (red)
- 100 units per pack













An ingenious tools to enhance your creative ideas and be more efficient!



PROFILE	LENGTH	LENSES
 <p>3150 QTY - Profile</p>	<p>Available in straight section of 8 feet (96 inches/2.4 m). *Cut on site</p>	 <p>PR - Prime lens</p>  <p>SIL - SiLens</p>
QUANTITY	X <b>96 INCHES</b> LENGTH	LENS

ENDCAPS		JOINERS			ACCESSORIES
 <p>3150 left endcap</p>	 <p>3150 right endcap</p>	 <p>Type A straight joiner</p>	 <p>Type A horz. 45°/135° joiner</p>	 <p>Type A horz. 90° joiner</p>	 <p>Drywall small head screw (x100)</p>
QUANTITY	QUANTITY	QUANTITY	QUANTITY	QUANTITY	QUANTITY

**LED engine will be assembled on site. See Appendix 3 on page 159 to see how to calculate total ordering length.**

COLOR TEMPERATURE	LUMEN PACKAGE*	LEAD IN/OUT	USAGE	POWER SUPPLY/CONTROL	LENGTH
<ul style="list-style-type: none"> <li> 24 - 2400K</li> <li> 27 - 2700K</li> <li> 30 - 3000K</li> <li> 35 - 3500K</li> <li> 42 - 4200K</li> <li> 53 - 5300K (LHP only)</li> <li> 62 - 6200K (LP only)</li> <li> WD1 - WarmDim 14W</li> <li> TW1 - Tunable White 11W</li> <li> TW2 - Tunable White 19W</li> <li> RGB1 - RGB 14W</li> <li> RGB2 - RGB 19W</li> </ul>	<ul style="list-style-type: none"> <li>LP0 - 128 LM / 1.5W FT / 90+CRI</li> <li>LP1 - 160 LM / 1.5W FT / 90+CRI</li> <li>LP2 - 255 LM / 3.0W FT / 90+CRI</li> <li>LP3 - 308 LM / 4.5W FT / 90+CRI</li> <li>LP4 - 400 LM / 5.8W FT / 90+CRI</li> <li>LHP - 700 LM / 7.0W FT / 95+CRI</li> </ul> <p><b>Note:</b> Not applicable for Warmdim, Tunable White and RGB color temperatures</p>	<ul style="list-style-type: none"> <li>HW3 - Hardwire 3 FT</li> <li>HW6 - Hardwire 6 FT</li> <li>HW9 - Hardwire 9 FT</li> <li>HWX - Hardwire custom FT</li> <li>NO - No lead</li> </ul>	<ul style="list-style-type: none"> <li>I - IP22 indoor dry location</li> </ul>	<ul style="list-style-type: none"> <li>A - Non-dimming</li> <li>B - ELV dimming 120V AC</li> <li>C - ELV dimming 120/277 VAC**</li> <li>D - 0/10V dimming 120/277 VAC</li> <li>E - Non-dimming DC plug in</li> <li>F - DMX</li> <li>G - Lutron - HI-LUME PREMIER 0,1% Eco System 24V/96W</li> <li>I - Casambi CBU-A2D-0/10V-DALI-Bluetooth 100/277 VAC</li> <li>J - Casambi CBU-PWM4-4CH-Bluetooth 100/277 VAC</li> <li>K - Casambi CBU-TED-CV-Trail edge dim-Bluetooth 120 VAC</li> <li>NO - No driver</li> </ul>	<p><b>Total length of LED engine in inches</b> - See Appendix 3 on how to calculate length.</p>
COLOR TEMPERATURE CCT	LUMEN PACKAGE	LEAD IN    LEAD OUT	USAGE	POWER SUPPLY/CONTROL	LED ENGINE LENGTH

\*NOTE: The light output is provided in lumens per foot, for a CCT of 4200K and a clear lens. Please refer to the optics page for CCT and translucency conversion factors. \*\* Only available in 96W - 24V Driver

# 3200 PROFILE

3000 Series



## Cross-section dimensions:

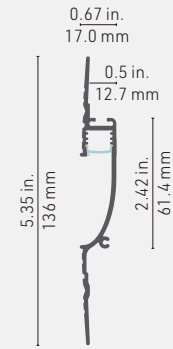

With its smooth and curved inner surface, the new 3200 recessed profile allows indirect lighting with a hollow effect, regardless of the height at which it is installed. What's new? The possibility of adding endcaps for a neat and elegant finish. The 3200 is ideal for residential or commercial applications that require high efficiency, safe lighting.

## FEATURES

- Direct adjustment with standard 1/2 inch gypsum panels and with 5/8 inch gypsum panels.
- Impeccable finish thanks to the grooves that allow the profile to be leveled to the wall surface using joint compound.
- Available in 96 inch (2.43 m) lengths for easy and accurate on-site installation. Optional endcaps, available.
- Equipped with a Prime lens for uniform illumination without light dots and optimal light diffusion.
- 8 mm LED light source: 4.8 W, 9.6 W, and 14.5 W, with 7 color temperatures (2400K to 6200K), IP22; also available in 10 mm width in 14.4 W-RGB.

## OPTIONS



## LED ENGINE COMPATIBILITY



Compatible with LED engines up to **10mm** wide.







## LINEAR WEIGHT

0.330lbs/ft, 0.491kg/m (without lens)

















PROFILE	LENGTH	LENSES
 <p>3200 QTY - Profile</p>	<p>Available in straight section of 8 feet (96 inches/2.4 m). *Cut on site</p>	 <p>PR - Prime lens</p>  <p>SIL - SiLens</p>
QUANTITY	X <b>96 INCHES</b> LENGTH	LENS

ENDCAPS		JOINERS			ACCESSORIES
 <p>3200 left endcap</p>	 <p>3200 right endcap</p>	 <p>Type A straight joiner</p>	 <p>Type A horz. 45°/135° joiner</p>	 <p>Type A horz. 90° joiner</p>	 <p>Drywall small head screw (x100)</p>
QUANTITY	QUANTITY	QUANTITY	QUANTITY	QUANTITY	QUANTITY

**LED engine will be assembled on site. See Appendix 3 on page 159 to see how to calculate total ordering length.**

COLOR TEMPERATURE	LUMEN PACKAGE*	LEAD IN/OUT	USAGE	POWER SUPPLY/CONTROL	LENGTH
<ul style="list-style-type: none"> <li> 24 - 2400K</li> <li> 27 - 2700K</li> <li> 30 - 3000K</li> <li> 35 - 3500K</li> <li> 42 - 4200K</li> <li> 53 - 5300K (LHP only)</li> <li> 62 - 6200K (LP only)</li> <li> WD1 - WarmDim 14W</li> <li> TW1 - Tunable White 11W</li> <li> TW2 - Tunable White 19W</li> <li> RGB1 - RGB 14W</li> <li> RGB2 - RGB 19W</li> </ul>	<ul style="list-style-type: none"> <li>LP0 - 128 LM / 1.5W FT / 90+CRI</li> <li>LP1 - 160 LM / 1.5W FT / 90+CRI</li> <li>LP2 - 255 LM / 3.0W FT / 90+CRI</li> <li>LP3 - 308 LM / 4.5W FT / 90+CRI</li> <li>LP4 - 400 LM / 5.8W FT / 90+CRI</li> <li>LHP - 700 LM / 7.0W FT / 95+CRI</li> </ul> <p><b>Note:</b> Not applicable for WarmDim, Tunable White and RGB color temperatures</p>	<ul style="list-style-type: none"> <li>HW3 - Hardwire 3 FT</li> <li>HW6 - Hardwire 6 FT</li> <li>HW9 - Hardwire 9 FT</li> <li>HWX - Hardwire custom FT</li> <li>NO - No lead</li> </ul>	<ul style="list-style-type: none"> <li>I - IP22 indoor dry location</li> </ul>	<ul style="list-style-type: none"> <li>A - Non-dimming</li> <li>B - ELV dimming 120V AC</li> <li>C - ELV dimming 120/277 VAC**</li> <li>D - 0/10V dimming 120/277 VAC</li> <li>E - Non-dimming DC plug in</li> <li>F - DMX</li> <li>G - Lutron - HI-LUME PREMIER 0,1% Eco System 24V/96W</li> <li>I - Casambi CBU-A2D-0/10V-DALI-Bluetooth 100/277 VAC</li> <li>J - Casambi CBU-PWM4-4CH-Bluetooth 100/277 VAC</li> <li>K - Casambi CBU-TED-CV-Trail edge dim-Bluetooth 120 VAC</li> <li>NO - No driver</li> </ul>	<p><b>Total length of LED engine in inches</b> - See Appendix 3 on how to calculate length.</p>

COLOR TEMPERATURE CCT      LUMEN PACKAGE      LEAD IN      LEAD OUT      USAGE      POWER SUPPLY/CONTROL      LED ENGINE LENGTH

\*NOTE: The light output is provided in lumens per foot, for a CCT of 4200K and a clear lens. Please refer to the optics page for CCT and translucency conversion factors. \*\* Only available in 96W - 24V Driver

TITLE 24



# 4000 SERIES

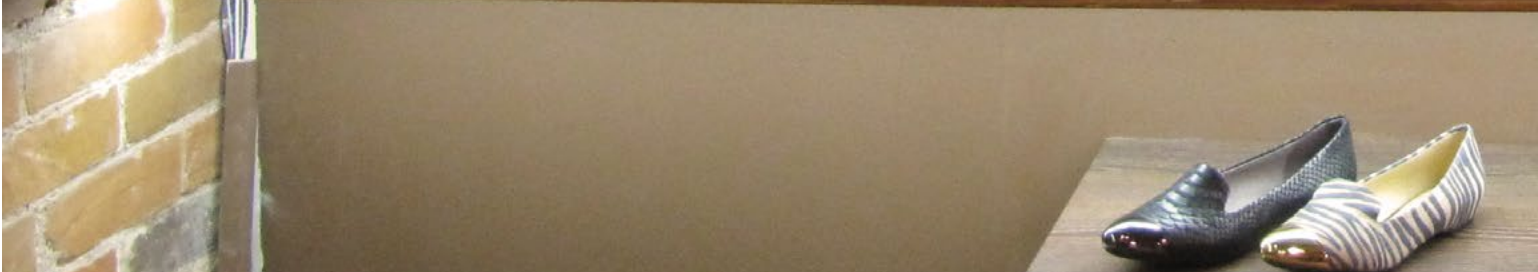



# 4200 PROFILE

4000 Series

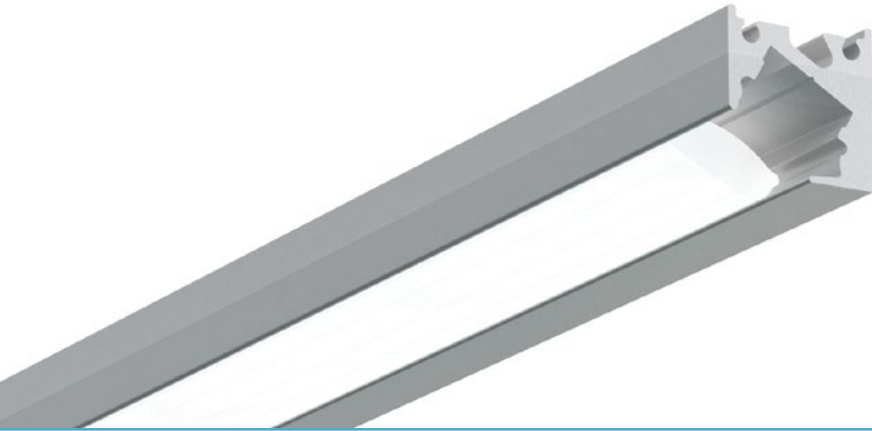

## Cross-section dimensions:

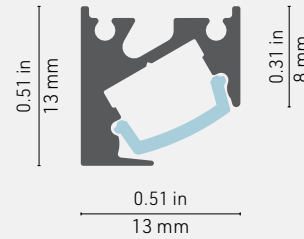

## NEW! ELEGANCE AND DISCRETION

Our range of ultra-compact profiles has been expanded! The 4200 profile provides accent lighting at an angle of 30° to highlight products on shelves or to cut out the underside of cabinets. Compatible with the new SiLens made of flexible silicone, which can be installed at the touch of a finger. A notch on the underside completely conceals the TR64 mounting wire, giving the luminaire an even more aesthetic look. Ideal for commercial or residential applications.

### FEATURES

- Ultra-compact aluminum profile: 13 mm x 13 mm (1/2" x 1/2")
- Custom length from 2 to 240 inches (6 m)
- 30° lighting angle
- 4 lumen packages: LP0 (128 lm/1.5 W/ft), LP1 (160 lm/1.5 W/ft), LP2 (255 lm/3.0 W/ft) and LP3 (308 lm/4.5 W/ft) in a width of 8 mm
- 6 color temperatures (2400 K to 6200 K), CRI 90+
- Compatible with the new SiLens, in flexible silicone
- Notch concealing the TR64 mounting wire
- Surface installation with 3M double-sided tape
- Offered in hardwire only
- Indoor use, IP22
- Designed to meet North American woodworking standards

### OPTIONS

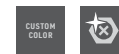

### LED STRIP COMPATIBILITY

Compatible with LED strips up to **8mm** wide.

### LINEAR WEIGHT

0.0442 lbs/ft, 65.83g/m











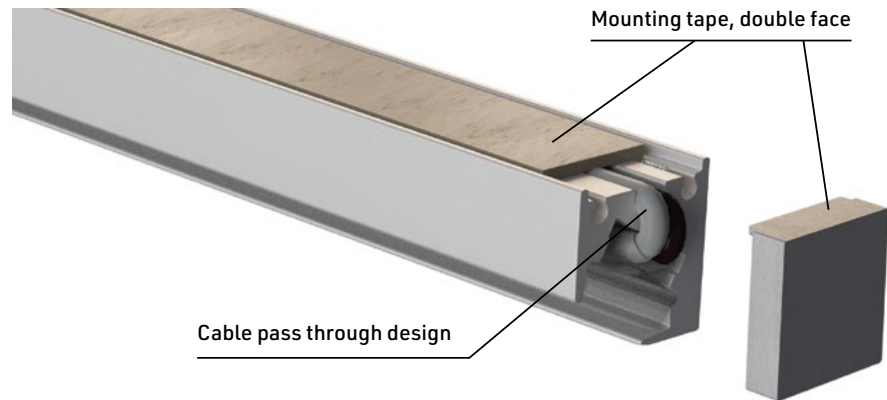









## INTELLIGENT DESIGN

A notch on the underside completely conceals the TR64 mounting wire, giving the luminaire an even more aesthetic look. The encaps are also pass-through and the extrusion has been designed with a recess to insert the mounting tape.



PROFILE	LENSES	MOUNTING HARDWARE	LENGTH
 4200 - Profile, alu	 SIL - SiLens	 3M - Mounting tape, double face	Custom length by sections of 2 to 240 inches (6m).
 4201 - Profile, black	 NO - No lens	 NO - No mounting hardware	
 4202 - Profile, white			



COLOR TEMPERATURE	LUMEN PACKAGE*	LEAD IN/OUT	USAGE	POWER SUPPLY/CONTROL	*NOTES
<ul style="list-style-type: none"> <li> 24 - 2400K</li> <li> 27 - 2700K</li> <li> 30 - 3000K</li> <li> 35 - 3500K</li> <li> 42 - 4200K</li> <li> 62 - 6200K</li> </ul>	<ul style="list-style-type: none"> <li>LP0 - 128 LM / 1.5W FT / 90+CRI</li> <li>LP1 - 160 LM / 1.5W FT / 90+CRI</li> <li>LP2 - 255 LM / 3.0W FT / 90+CRI</li> <li>LP3 - 308 LM / 4.5W FT / 90+CRI</li> </ul>	<ul style="list-style-type: none"> <li>HW3 - Hardwire 3 FT</li> <li>HW6 - Hardwire 6 FT</li> <li>HW9 - Hardwire 9 FT</li> <li>HWX - Hardwire custom FT</li> <li>DC3 - DC plug 3 FT</li> <li>DC6 - DC plug 6 FT</li> <li>DC9 - DC plug 9 FT</li> <li>DCX - DC plug custom FT</li> <li>NO - No lead</li> </ul>	<ul style="list-style-type: none"> <li>I - IP22 indoor dry location</li> </ul>	<ul style="list-style-type: none"> <li>A - Non-dimming</li> <li>B - ELV dimming 120V AC</li> <li>C - ELV dimming 120/277 VAC**</li> <li>D - 0/10V dimming 120/277 VAC</li> <li>E - Non-dimming DC plug in</li> <li>F - DMX</li> <li>G - Lutron - HI-LUME PREMIER 0,1% Eco System 24V/96W</li> <li>I - Casambi CBU-A2D-0/10V-DALI-Bluetooth 100/277 VAC</li> <li>J - Casambi CBU-PWM4-4CH-Bluetooth 100/277 VAC</li> <li>K - Casambi CBU-TED-CV-Trail edge dim-Bluetooth 120 VAC</li> <li>NO - No driver</li> </ul>	<p>*The light output is provided in lumens per foot, for a CCT of 4200K and a clear lens. Please refer to the optics page for CCT and translucency conversion factors.</p> <p>** Only available in 96W - 24V Driver</p> 

COLOR TEMPERATURE CCT      LUMEN PACKAGE      LEAD IN      LEAD OUT      USAGE      POWER SUPPLY/CONTROL

4000

# 4250 PROFILE

4000 Series



Cross-section dimensions:

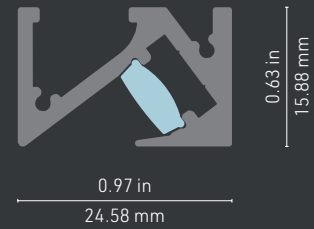

## THE ELEGANCE OF SIMPLICITY

A new compact profile has been added to this thin series! Profile 4250 provides accent lighting at an angle of 53° to highlight products on shelves or to cut out the underside of cabinets. Exclusively: the new high-end SiLens lens made of flexible silicone, which can be installed with a simple touch of the finger. Even better, the phantom brackets perfectly conceal the surface installation. Ideal for commercial or residential applications.

### FEATURES

- Compact aluminum profile: 24.58 mm x 15.88 mm (0.97 in x 0.63 in)
- Custom lengths from 2 to 192 inches (4.88 m/16 ft) in aluminum, and 2 to 240 inches (6 m/20 ft) in black
- 53° lighting angle
- 4 lumen packages: LP0 (128 lm/1.5 W/ft), LP1 (160 lm/1.5 W/ft), LP2 (255 lm/3.0 W/ft) et LP3 (308 lm/4.5 W/ft) in 8 mm width with 5 mm tape guide
- 6 color temperatures (2400 K to 6200 K), CRI 90+
- Exclusive optics: SiLens, made of flexible silicone
- End caps with milled hole on both sides for the feed wire
- Surface installation with phantom brackets
- Optional power supply unit with DC socket or hardwire connection
- Indoor use, IP22

### OPTIONS



#### LED STRIP COMPATIBILITY

Compatible with LED strips up to **8 mm** wide.

#### LINEAR WEIGHT

0.25 lbs/ft, 370g/m

#### RECESSED INSTALLATION IN 5/8" GROOVE

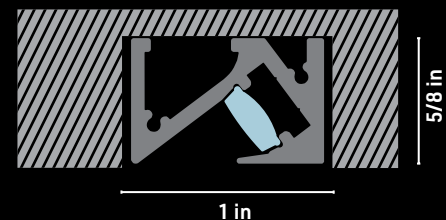





APPLICATION AREAS











## AN INTELLIGENT DESIGN

A notch on the underside completely conceals the TR64 mounting wire, giving the luminaire an even more aesthetic look. The encaps are also pass-through and the extrusion has been designed with a recess to insert the mounting clips.



PROFILE	LENSES	MOUNTING HARDWARE	LENGTH
 4250 -Profile, alu	 SIL - SiLens   NO -No lens	 PH - Phantom bracket   NO - No mounting hardware	Custom length by sections of 2 to 240 inches (6m).
 4251 -Profile, black			
 4252 - Profile, white			

PROFILE	SIL	MOUNTING HARDWARE	LENGTH
---------	-----	-------------------	--------

4000

COLOR TEMPERATURE	LUMEN PACKAGE*	LEAD IN/OUT	USAGE	POWER SUPPLY/CONTROL	*NOTES
<ul style="list-style-type: none"> <li><span style="display: inline-block; width: 15px; height: 10px; background-color: #e67e22; border: 1px solid black; margin-right: 5px;"></span> 24 - 2400K</li> <li><span style="display: inline-block; width: 15px; height: 10px; background-color: #f1c40f; border: 1px solid black; margin-right: 5px;"></span> 27 - 2700K</li> <li><span style="display: inline-block; width: 15px; height: 10px; background-color: #f1c40f; border: 1px solid black; margin-right: 5px;"></span> 30 - 3000K</li> <li><span style="display: inline-block; width: 15px; height: 10px; background-color: #f1c40f; border: 1px solid black; margin-right: 5px;"></span> 35 - 3500K</li> <li><span style="display: inline-block; width: 15px; height: 10px; background-color: #f1c40f; border: 1px solid black; margin-right: 5px;"></span> 42 - 4200K</li> <li><span style="display: inline-block; width: 15px; height: 10px; background-color: #f1c40f; border: 1px solid black; margin-right: 5px;"></span> 62 - 6200K</li> </ul>	<ul style="list-style-type: none"> <li><b>LP0</b> - 128 LM / 1.5W FT / 90+CRI</li> <li><b>LP1</b> - 160 LM / 1.5W FT / 90+CRI</li> <li><b>LP2</b> - 255 LM / 3.0W FT / 90+CRI</li> <li><b>LP3</b> - 308 LM / 4.5W FT / 90+CRI</li> </ul>	<ul style="list-style-type: none"> <li><b>HW3</b> - Hardwire 3 FT</li> <li><b>HW6</b> - Hardwire 6 FT</li> <li><b>HW9</b> - Hardwire 9 FT</li> <li><b>HWX</b> - Hardwire custom FT</li> <li><b>DC3</b> - DC plug 3 FT</li> <li><b>DC6</b> - DC plug 6 FT</li> <li><b>DC9</b> - DC plug 9 FT</li> <li><b>DCX</b> - DC plug custom FT</li> <li><b>NO</b> - No lead</li> </ul>	<ul style="list-style-type: none"> <li><b>I</b> - IP22 indoor dry location</li> </ul>	<ul style="list-style-type: none"> <li><b>A</b> - Non-dimming</li> <li><b>B</b> - ELV dimming 120V AC</li> <li><b>C</b> - ELV dimming 120/277 VAC**</li> <li><b>D</b> - 0/10V dimming 120/277 VAC</li> <li><b>E</b> - Non-dimming DC plug in</li> <li><b>F</b> - DMX</li> <li><b>G</b> - Lutron - HI-LUME PREMIER 0,1% Eco System 24V/96W</li> <li><b>I</b> - Casambi CBU-A2D-0/10V-DALI-Bluetooth 100/277 VAC</li> <li><b>J</b> - Casambi CBU-PWM4-4CH-Bluetooth 100/277 VAC</li> <li><b>K</b> - Casambi CBU-TED-CV-Trail edge dim-Bluetooth 120 VAC</li> <li><b>NO</b> - No driver</li> </ul>	<p>*The light output is provided in lumens per foot, for a CCT of 4200K and a clear lens. Please refer to the optics page for CCT and translucency conversion factors.</p> <p>** Only available in 96W - 24V Driver</p> <div style="border: 1px solid black; padding: 5px; width: fit-content; margin-top: 10px;"> <p>TITLE <b>24</b> COMP-100</p> </div>

COLOR TEMPERATURE CCT	LUMEN PACKAGE	LEAD IN	LEAD OUT	I	POWER SUPPLY/CONTROL
-----------------------	---------------	---------	----------	---	----------------------

# 4260 PROFILE

4000 Series



Cross-section dimensions:

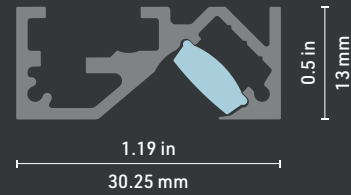

## THE ELEGANCE OF SIMPLICITY

A new compact profile has been added to this thin series! Profile 4260 provides accent lighting at an angle of 53° to highlight products on shelves or to cut out the underside of cabinets. Exclusively: the new high-end SiLens lens made of flexible silicone, which can be installed with a simple touch of the finger. Even better, the phantom brackets perfectly conceal the surface installation. Ideal for commercial or residential applications.

### FEATURES

- Compact aluminum profile: 30.25 mm x 13 mm (1.19 in x 0.5 in)
- Custom lengths from 2 to 192 inches (4.88 m/16 ft) in aluminum
- 53° lighting angle
- 4 lumen packages: LP0 (128 lm/1.5 W/ft), LP1 (160 lm/1.5 W/ft), LP2 (255 lm/3.0 W/ft) et LP3 (308 lm/4.5 W/ft) in 8 mm width with 5 mm tape guide
- 6 color temperatures (2400 K to 6200 K), CRI 90+
- Exclusive optics: SiLens, made of flexible silicone
- End caps with milled hole on both sides for the feed wire
- Surface installation with phantom brackets
- Optional power supply unit with DC socket or hardwire connection
- Indoor use, IP22



### LED STRIP COMPATIBILITY

Compatible with LED strips up to **8 mm** wide.

### LINEAR WEIGHT

0.25 lbs/ft, 370g/m

### RECESSED INSTALLATION IN 1/2" GROOVE

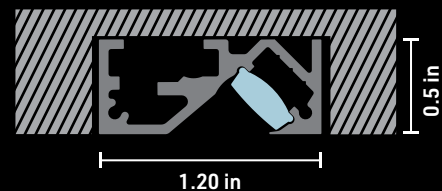



## APPLICATION AREAS

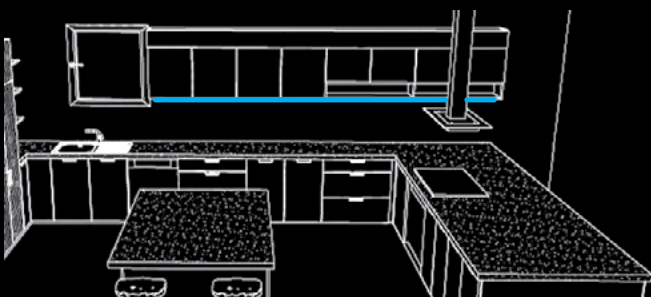







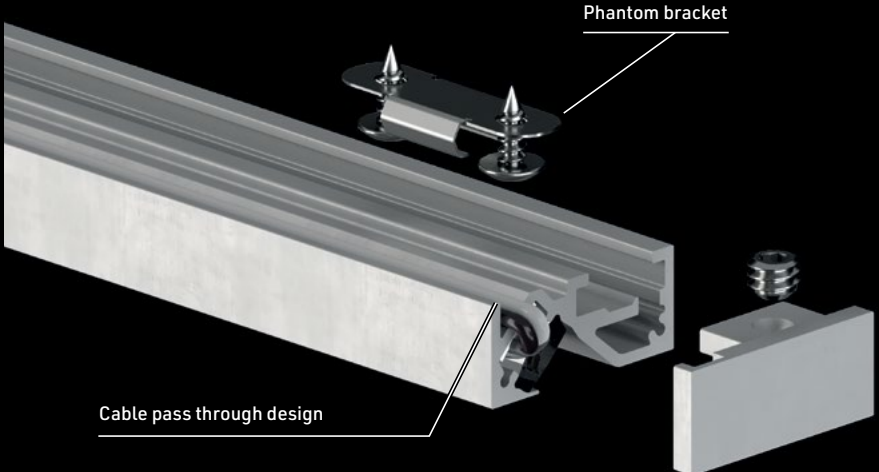

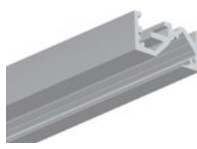
## AN INTELLIGENT DESIGN

A notch on the underside completely conceals the TR64 mounting wire, giving the luminaire an even more aesthetic look. The encaps are also pass-through and the extrusion has been designed with a recess to insert the mounting clips.



PROFILE	LENSES	MOUNTING HARDWARE	LENGTH
 4260 - Profile, alu	 SIL - SiLens  NO - No lens	 PH - Phantom bracket  NO - No mounting hardware	Custom length by sections of 2 to 192 inches (6m).
 4261 - Profile, black			
 4262 - Profile, white			



4000

COLOR TEMPERATURE	LUMEN PACKAGE*	LEAD IN/OUT	USAGE	POWER SUPPLY/CONTROL	*NOTES
<ul style="list-style-type: none"> <li><span style="display: inline-block; width: 15px; height: 10px; background-color: #f4a460; border: 1px solid black; margin-right: 5px;"></span> 24 - 2400K</li> <li><span style="display: inline-block; width: 15px; height: 10px; background-color: #f4c996; border: 1px solid black; margin-right: 5px;"></span> 27 - 2700K</li> <li><span style="display: inline-block; width: 15px; height: 10px; background-color: #f4e1d9; border: 1px solid black; margin-right: 5px;"></span> 30 - 3000K</li> <li><span style="display: inline-block; width: 15px; height: 10px; background-color: #f4f2e1; border: 1px solid black; margin-right: 5px;"></span> 35 - 3500K</li> <li><span style="display: inline-block; width: 15px; height: 10px; background-color: #f4f9e1; border: 1px solid black; margin-right: 5px;"></span> 42 - 4200K</li> <li><span style="display: inline-block; width: 15px; height: 10px; background-color: #f4f9e1; border: 1px solid black; margin-right: 5px;"></span> 62 - 6200K</li> </ul>	<ul style="list-style-type: none"> <li><b>LP0</b> - 128 LM / 1.5W FT / 90+CRI</li> <li><b>LP1</b> - 160 LM / 1.5W FT / 90+CRI</li> <li><b>LP2</b> - 255 LM / 3.0W FT / 90+CRI</li> <li><b>LP3</b> - 308 LM / 4.5W FT / 90+CRI</li> </ul>	<ul style="list-style-type: none"> <li><b>HW3</b> - Hardwire 3 FT</li> <li><b>HW6</b> - Hardwire 6 FT</li> <li><b>HW9</b> - Hardwire 9 FT</li> <li><b>HWX</b> - Hardwire custom FT</li> <li><b>DC3</b> - DC plug 3 FT</li> <li><b>DC6</b> - DC plug 6 FT</li> <li><b>DC9</b> - DC plug 9 FT</li> <li><b>DCX</b> - DC plug custom FT</li> <li><b>NO</b> - No lead</li> </ul>	<ul style="list-style-type: none"> <li><b>I</b> - IP22 indoor dry location</li> </ul>	<ul style="list-style-type: none"> <li><b>A</b> - Non-dimming</li> <li><b>B</b> - ELV dimming 120V AC</li> <li><b>C</b> - ELV dimming 120/277 VAC**</li> <li><b>D</b> - 0/10V dimming 120/277 VAC</li> <li><b>E</b> - Non-dimming DC plug in</li> <li><b>F</b> - DMX</li> <li><b>G</b> - Lutron - HI-LUME PREMIER 0,1% Eco System 24V/96W</li> <li><b>I</b> - Casambi CBU-A2D-0/10V-DALI-Bluetooth 100/277 VAC</li> <li><b>J</b> - Casambi CBU-PWM4-4CH-Bluetooth 100/277 VAC</li> <li><b>K</b> - Casambi CBU-TED-CV-Trail edge dim-Bluetooth 120 VAC</li> <li><b>NO</b> - No driver</li> </ul>	<ul style="list-style-type: none"> <li>*The light output is provided in lumens per foot, for a CCT of 4200K and a clear lens. Please refer to the optics page for CCT and translucency conversion factors.</li> <li>** Only available in 96W - 24V Driver</li> </ul>



# 4400 PROFILE

4000 Series



Cross-section dimensions:

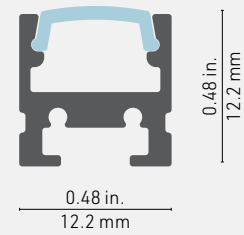

## ONE OF THE SMALLEST ON THE MARKET

**Guaranteed to be discreet!** The 4400 profile is reduced to a minimum with its size of less than half an inch, while accepting a good range of LED engines<sup>1</sup>.

(1) Accepts LED engines up to 8mm wide.

### FEATURES

- Ultra-compact aluminum profile – 12.2mm wide by 12.2mm high (0.5 x 0.5in).
- Custom length by sections of 2 to 240 inches (6m).
- Made of ALCOA 6063-T5 aluminum alloy increasing heat dissipation.
- Its use increases the lifetime of your LED engine.
- Compatible with multiple installation accessories.
- Designed to meet North American woodworking standards.

### OPTIONS

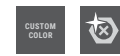

### LED STRIP COMPATIBILITY









Compatible with LED strips up to **8mm** wide.





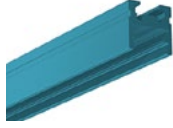

### LINEAR WEIGHT

0.108 lbs/ft, 0.160 kg/m





PROFILE	LENSES	MOUNTING HARDWARE	LENGTH
 <b>4400</b> - 4400 Profile, alu	 <b>CL</b> - Clear lens	 <b>FL</b> - Flat bracket	Custom length by sections of 2 to 240 inches (6m).
 <b>4401</b> - 4400 Profile, black	 <b>OX</b> - Optiflex lens	 <b>NO</b> - No mounting hardware	
 <b>440X</b> - 4400 Profile, custom color IMPORTANT: Give RAL color No. See Appendix 1 on page 158	 <b>OP</b> - Opal lens	 <b>NO</b> - No lens	
RAL NUMBER			
PROFILE	LENS	MOUNTING HARDWARE	LENGTH

COLOR TEMPERATURE	LUMEN PACKAGE*	LEAD IN/OUT	USAGE	POWER SUPPLY/CONTROL	*NOTES
 <b>24</b> - 2400K  <b>27</b> - 2700K  <b>30</b> - 3000K  <b>35</b> - 3500K  <b>42</b> - 4200K  <b>53</b> - 5300K	<b>LP0</b> - 128 LM / 1.5W FT / 90+CRI <b>LP1</b> - 160 LM / 1.5W FT / 90+CRI <b>LP2</b> - 255 LM / 3.0W FT / 90+CRI <b>LP3</b> - 308 LM / 4.5W FT / 90+CRI	<b>HW3</b> - Hardwire 3 FT <b>HW6</b> - Hardwire 6 FT <b>HW9</b> - Hardwire 9 FT <b>HWX</b> - Hardwire custom FT <b>DC3</b> - DC plug 3 FT <b>DC6</b> - DC plug 6 FT <b>DC9</b> - DC plug 9 FT <b>DCX</b> - DC plug custom FT <b>NO</b> - No lead	<b>I</b> - IP22 indoor dry location	<b>A</b> - Non-dimming <b>B</b> - ELV dimming 120V AC <b>C</b> - ELV dimming 120/277 VAC** <b>D</b> - 0/10V dimming 120/277 VAC <b>E</b> - Non-dimming DC plug in <b>F</b> - DMX <b>G</b> - Lutron - HI-LUME PREMIER 0,1% Eco System 24V/96W <b>I</b> - Casambi CBU-A2D-0/10V-DALI-Bluetooth 100/277 VAC <b>J</b> - Casambi CBU-PWM4-4CH-Bluetooth 100/277 VAC <b>K</b> - Casambi CBU-TED-CV-Trail edge dim-Bluetooth 120 VAC <b>NO</b> - No driver	*The light output is provided in lumens per foot, for a CCT of 4200K and a clear lens. Please refer to the optics page for CCT and translucency conversion factors.  ** Only available in 96W - 24V Driver  
COLOR TEMPERATURE CCT	LUMEN PACKAGE	LEAD IN LEAD OUT	USAGE	POWER SUPPLY/CONTROL	

# 4500 PROFILE

4000 Series



## Cross-section dimensions:

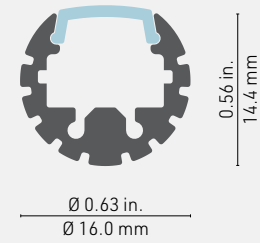

## MEET OUR MAGIC WAND!

A well cherished secret that we just have to brag about. The 4500 is a slim but extremely versatile display solution. With its **ultra-compact size** and its **complete freedom of lighting direction**, and accepting most LED engines<sup>1</sup>, you will find many ways to install it with its wide variety of accessories.

(1) Accepts LED engines ranging up to 10mm wide.

### FEATURES

- Ultra-compact size with a diameter of only 16mm (5/8in).
- All of the 4500 brackets allow adjusting lighting direction along the axis as desired.
- Custom length by sections of 2 to 240 inches (6m).
- Made of ALCOA 6063-T5 aluminum alloy increasing heat dissipation.
- Its use increases the lifetime of your LED engine.
- Compatible with multiple installation accessories.
- Designed to meet North American woodworking standards.

### OPTIONS











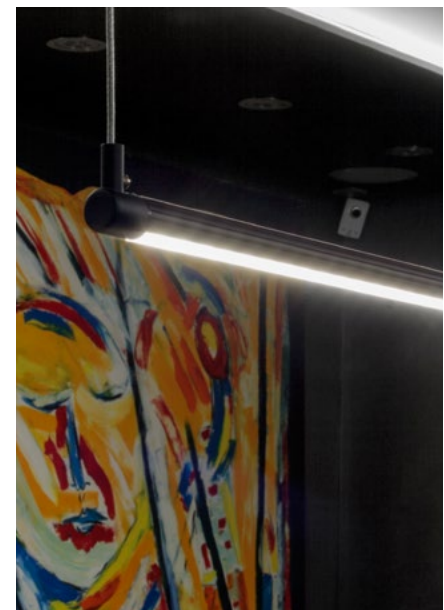













### LED ENGINE COMPATIBILITY

Compatible with LED engines up to **10mm** wide.

### LINEAR WEIGHT

0.147 lbs/ft, 0.218 kg/m



PROFILE	LENSES	MOUNTING HARDWARE	CANOPY	LENGTH
 <p>4500 - 4500 Profile, alu</p>  <p>4501 - 4501 Profile, black</p>	<p><b>CL</b> - Clear lens</p>  <p><b>OX</b> - Optiflex lens</p>  <p><b>OP</b> - Opal lens</p>  <p><b>SIL</b> - SiLens</p>  <p><b>NO</b> - No lens</p> 	<p><b>FL</b> - Flat bracket</p>  <p><b>U0</b> - "U" bracket, Alu</p>  <p><b>P0</b> - "P" bracket, Alu</p>  <p><b>VS</b> - Arm kit vertical surface Maximum = 12"</p>  <p><b>VI</b> - Arm kit vertical insert Maximum = 12"</p>  <p><b>HS</b> - Arm kit horizontal surface Maximum = 12"</p>  <p><b>HI</b> - Arm kit horizontal insert Maximum = 12"</p>  <p><b>NO</b> - No mounting hardware</p>  <p><b>SUS</b> - 4500 endcap suspension kit with 15ft. coax. cable</p> 	<p><b>NOTE:</b> Only available with <b>SUS</b> bracket (suspension)</p>  <p><b>Remote driver canopy plate</b> See Appendix 2 on page 158 <b>CR0</b> - Alu <b>CR1</b> - Black <b>CR2</b> - White</p>  <p><b>Integrated driver in canopy</b> See Appendix 2 on page 158 <b>CI0</b> - Alu <b>CI1</b> - Black <b>CI2</b> - White</p>  <p><b>Integrated driver &amp; suspension kit</b> See Appendix 2 on page 158 <b>CIK0</b> - Alu <b>CIK1</b> - Black <b>CIK2</b> - White</p>  <p><b>NO</b> - No canopy</p> 	<p>Custom length by sections of 2 to 60 inches (1.5m).</p>
PROFILE	LENS	MOUNTING HARDWARE	CANOPY	LENGTH

### COLOR TEMPERATURE

	24 - 2400K
	27 - 2700K
	30 - 3000K
	35 - 3500K
	42 - 4200K
	53 - 5300K (LHP only)
	62 - 6200K (LP only)
	WD1 - WarmDim 14W
	TW1 - Tunable White 11W
	TW2 - Tunable White 19W
	RGB1 - RGB 14W
	RGB2 - RGB 19W

COLOR TEMPERATURE CCT

### LUMEN PACKAGE\*

<b>LP0</b>	- 128 LM / 1.5W FT / 90+CRI
<b>LP1</b>	- 160 LM / 1.5W FT / 90+CRI
<b>LP2</b>	- 255 LM / 3.0W FT / 90+CRI
<b>LP3</b>	- 308 LM / 4.5W FT / 90+CRI
<b>LP4</b>	- 400 LM / 5.8W FT / 90+CRI
<b>LHP</b>	- 700 LM / 7.0W FT / 95+CRI

**Note:** Not applicable for Warmdim, Tunable White and RGB color temperatures

LUMEN PACKAGE

### LEAD IN/OUT

<b>HW3</b>	- Hardwire 3 FT
<b>HW6</b>	- Hardwire 6 FT
<b>HW9</b>	- Hardwire 9 FT
<b>HWX</b>	- Hardwire custom FT
<b>DC3</b>	- DC plug 3 FT
<b>DC6</b>	- DC plug 6 FT
<b>DC9</b>	- DC plug 9 FT
<b>DCX</b>	- DC plug custom FT
<b>SUS</b>	- Coaxial wire 15 Ft
<b>NO</b>	- No lead

LEAD IN LEAD OUT

### USAGE

I - IP22 indoor dry location

I

USAGE

### POWER SUPPLY/CONTROL

<b>A</b>	- Non-dimming
<b>B</b>	- ELV dimming 120V AC
<b>C</b>	- ELV dimming 120/277 VAC**
<b>D</b>	- 0/10V dimming 120/277 VAC
<b>E</b>	- Non-dimming DC plug in
<b>F</b>	- DMX
<b>G</b>	- Lutron - HI-LUME PREMIER 0,1% Eco System 24V/96W
<b>I</b>	- Casambi CBU-A2D-0/10V-DALI-Bluetooth 100/277 VAC
<b>J</b>	- Casambi CBU-PWM4-4CH-Bluetooth 100/277 VAC
<b>K</b>	- Casambi CBU-TED-CV-Trail edge dim-Bluetooth 120 VAC
<b>NO</b>	- No driver

POWER SUPPLY/CONTROL

### \*NOTES

\*The light output is provided in lumens per foot, for a CCT of 4200K and a clear lens. Please refer to the optics page for CCT and translucency conversion factors.

\*\* Only available in 96W - 24V Driver

TITLE 24



# 5000 SERIES





# 5000 PROFILE

5000 Series

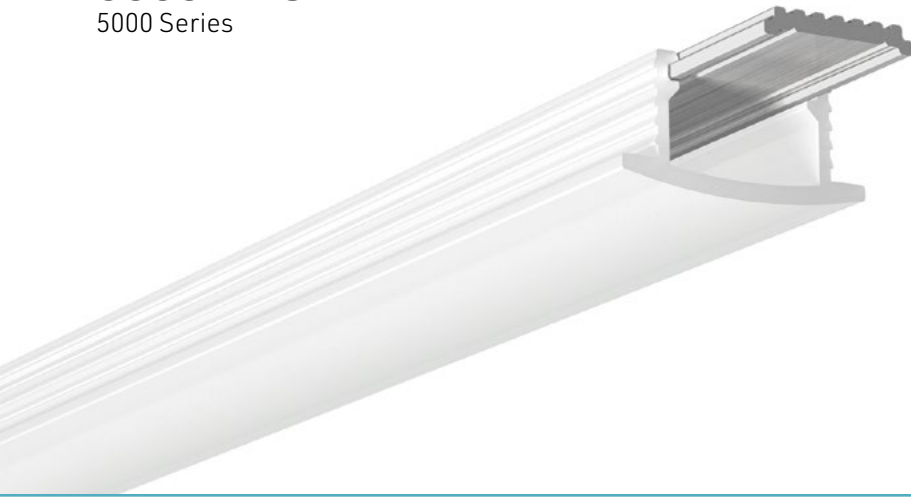

## Cross-section dimensions:

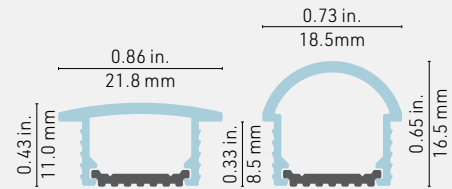

## SIMPLICITY ITSELF!

The 5000 consists of an **aluminum heatsink base** inserted into a **flexible recessed lens** with gripping sides. It allows for a very **simple installation**, with the assembly inserted into the recess and staying in place due to the gripping ribbed lens sides. The 5/8" wide and 3/8" deep recess is a direct fit for North American cabinetry, closet, or mural applications, besides being economical and providing lighting without hot spots.

### FEATURES

- Designed to give a uniform light without hot spots with the opal round lens.
- The 5200 (round) lens has a 0.31 inch (8mm) wall offset, while the 5300 (flanged) lens stands out only 1/10" (2.5mm).
- The LED heatsink base is made of aluminum for improved heat dissipation.
- The recess hole should be 5/8" (15.9mm) wide and 8.5mm (3/8 inch) deep minimum.
- Custom length by sections of 96 inches (2.44m).
- Application guide for 10mm (3/8 inch) LED engine or less.
- Designed to meet North American woodworking standards.

### OPTIONS



### LED ENGINE COMPATIBILITY

IP22: Compatible with LED engines up to **10mm** wide.





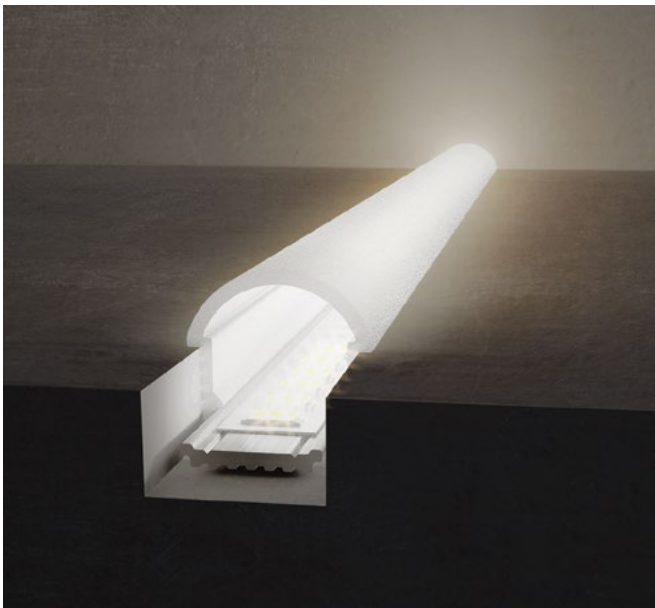







### LINEAR WEIGHT

0.035 lbs/ft, 0.052 kg/m (without lens)  
0.035 lbs/ft, 0.052 kg/m (with 5300 flanged lens)  
0.035 lbs/ft, 0.052 kg/m (with 5200 round lens)



PROFILE	LENSES	MOUNTING HARDWARE	LENGTH
 <p>5000 - 5000 Heatsink profile, alu</p>	 <p>OPF - Opal lens, flanged</p>  <p>OPR - Opal lens, round</p>  <p>NO - No lens</p>	 <p>3M - Mounting tape, double face</p>  <p>NO - No mounting hardware</p>	<p>Custom length by sections of 96 inches (2.44m).</p>
<b>5000</b>			
PROFILE	LENS	MOUNTING HARDWARE	LENGTH

5000

COLOR TEMPERATURE	LUMEN PACKAGE*	LEAD IN/OUT	USAGE	POWER SUPPLY/CONTROL	*NOTES
<ul style="list-style-type: none"> <li> 24 - 2400K</li> <li> 27 - 2700K</li> <li> 30 - 3000K</li> <li> 35 - 3500K</li> <li> 42 - 4200K</li> <li> 53 - 5300K (LHP only)</li> <li> 62 - 6200K (LP only)</li> <li> WD1 - WarmDim 14W</li> <li> TW1 - Tunable White 11W</li> <li> TW2 - Tunable White 19W</li> <li> RGB1 - RGB 14W</li> <li> RGB2 - RGB 19W</li> </ul>	<p>LP0 - 128 LM / 1.5W FT / 90+CRI</p> <p>LP1 - 160 LM / 1.5W FT / 90+CRI</p> <p>LP2 - 255 LM / 3.0W FT / 90+CRI</p> <p>LP3 - 308 LM / 4.5W FT / 90+CRI</p> <p>LP4 - 400 LM / 5.8W FT / 90+CRI</p> <p>LHP - 700 LM / 7.0W FT / 95+CRI</p> <p><b>Note:</b> Not applicable for Warmdim, Tunable White and RGB color temperatures</p>	<p>HW3 - Hardwire 3 FT</p> <p>HW6 - Hardwire 6 FT</p> <p>HW9 - Hardwire 9 FT</p> <p>HWX - Hardwire custom FT</p> <p>DC3 - DC plug 3 FT</p> <p>DC6 - DC plug 6 FT</p> <p>DC9 - DC plug 9 FT</p> <p>DCX - DC plug custom FT</p> <p>NO - No lead</p>	<p>I - IP22 indoor dry location</p> <p>O - IP68 wet/damp location</p>	<p>A - Non-dimming</p> <p>B - ELV dimming 120V AC</p> <p>C - ELV dimming 120/277 VAC**</p> <p>D - 0/10V dimming 120/277 VAC</p> <p>E - Non-dimming DC plug in</p> <p>F - DMX</p> <p>G - Lutron - HI-LUME PREMIER 0,1% Eco System 24V/96W</p> <p>I - Casambi CBU-A2D-0/10V-DALI-Bluetooth 100/277 VAC</p> <p>J - Casambi CBU-PWM4-4CH-Bluetooth 100/277 VAC</p> <p>K - Casambi CBU-TED-CV-Trail edge dim-Bluetooth 120 VAC</p> <p>NO - No driver</p>	<p>*The light output is provided in lumens per foot, for a CCT of 4200K and a clear lens. Please refer to the optics page for CCT and translucency conversion factors.</p> <p>** Only available in 96W - 24V Driver</p> <div style="border: 1px solid black; padding: 2px; display: inline-block;"> <p>TITLE <b>24</b> DIMMING</p> </div>
COLOR TEMPERATURE CCT	LUMEN PACKAGE	LEAD IN    LEAD OUT	USAGE	POWER SUPPLY/CONTROL	

# 5350 PROFILE

5000 Series

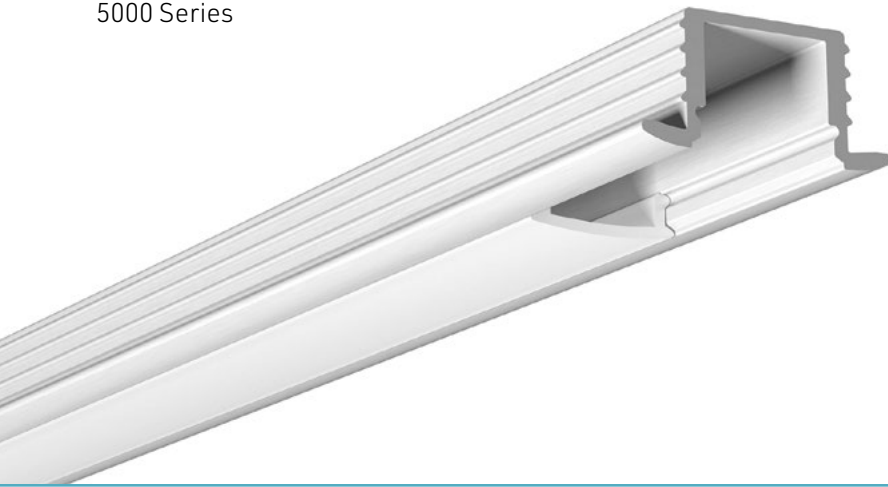

## Cross-section dimensions:

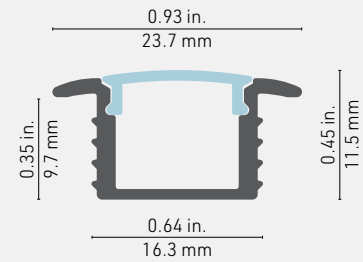

## A COMPACT RECESSED PROFILE

Here is a **compact recessed** profile allowing you to make the light source and the LED invisible. The edges on each side of this extrusion allow a recessed installation, giving it style with a discreet and neat appearance. This profile will **fit in a 5/8 inch** deep recess.

### FEATURES

- Designed to give a uniform light without hot spots with an opal or prime lens.
- Designed for a snug fit in a 5/8-inch (16mm) wide, 3/8-inch (10mm) deep recess.
- Custom length by sections of 96 inches (2.44m).
- Made of ALCOA 6063-T5 aluminum alloy increasing heat dissipation.
- Its use increases the lifetime of your LED engine.
- Compatible with multiple installation accessories.
- Designed to meet North American woodworking standards.

### OPTIONS



### LED ENGINE COMPATIBILITY









IP22: Compatible with LED engines up to **10mm** wide.

### LINEAR WEIGHT

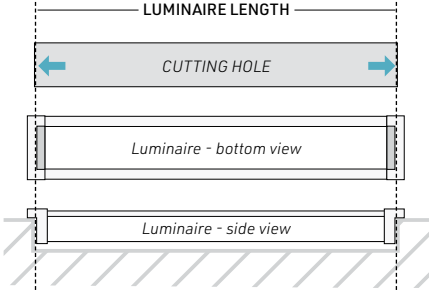











0.110 lbs/ft, 0.164 kg/m (without lens)





PROFILE	LENSES	MOUNTING HARDWARE	LENGTH
 5350 - 5350 Profile, alu	 OP - Opal lens	 3M - Mounting tape, double face	Custom length by sections of 2 to 96 inches (2.44m).  *NOTE: Follow this diagram to calculate the correct length  
 5351 - 5350 Profile, black	 PR - Prime lens	 NO - No mounting hardware	
 5352 - 5350 Profile, white	 NO - No lens		
 535X - 5350 Profile, custom color IMPORTANT: Give RAL color № See Appendix 1 on page 158			
RAL NUMBER			
PROFILE	LENS	MOUNTING HARDWARE	LENGTH

5000

COLOR TEMPERATURE	LUMEN PACKAGE*	LEAD IN/OUT	USAGE	POWER SUPPLY/CONTROL	*NOTES
<ul style="list-style-type: none"> <li> 24 - 2400K</li> <li> 27 - 2700K</li> <li> 30 - 3000K</li> <li> 35 - 3500K</li> <li> 42 - 4200K</li> <li> 53 - 5300K (LHP only)</li> <li> 62 - 6200K (LP only)</li> <li> WD1 - WarmDim 14W</li> <li> TW1 - Tunable White 11W</li> <li> TW2 - Tunable White 19W</li> <li> RGB1 - RGB 14W</li> <li> RGB2 - RGB 19W</li> </ul>	<ul style="list-style-type: none"> <li>LP0 - 128 LM / 1.5W FT / 90+CRI</li> <li>LP1 - 160 LM / 1.5W FT / 90+CRI</li> <li>LP2 - 255 LM / 3.0W FT / 90+CRI</li> <li>LP3 - 308 LM / 4.5W FT / 90+CRI</li> <li>LP4 - 400 LM / 5.8W FT / 90+CRI</li> <li>LHP - 700 LM / 7.0W FT / 95+CRI</li> </ul> <p><b>Note:</b> Not applicable for Warmdim, Tunable White and RGB color temperatures</p>	<ul style="list-style-type: none"> <li>HW3 - Hardwire 3 FT</li> <li>HW6 - Hardwire 6 FT</li> <li>HW9 - Hardwire 9 FT</li> <li>HWX - Hardwire custom FT</li> <li>NO - No lead</li> </ul>	<ul style="list-style-type: none"> <li>I - IP22 indoor dry location</li> </ul>	<ul style="list-style-type: none"> <li>A - Non-dimming</li> <li>B - ELV dimming 120V AC</li> <li>C - ELV dimming 120/277 VAC**</li> <li>D - 0/10V dimming 120/277 VAC</li> <li>E - Non-dimming DC plug in</li> <li>F - DMX</li> <li>G - Lutron - HI-LUME PREMIER 0,1% Eco System 24V/96W</li> <li>I - Casambi CBU-A2D-0/10V-DALI-Bluetooth 100/277 VAC</li> <li>J - Casambi CBU-PWM4-4CH-Bluetooth 100/277 VAC</li> <li>K - Casambi CBU-TED-CV-Trail edge dim-Bluetooth 120 VAC</li> <li>NO - No driver</li> </ul>	<p>*The light output is provided in lumens per foot, for a CCT of 4200K and a clear lens. Please refer to the optics page for CCT and translucency conversion factors.</p> <p>** Only available in 96W - 24V Driver</p> 
COLOR TEMPERATURE CCT	LUMEN PACKAGE	LEAD IN LEAD OUT	USAGE	POWER SUPPLY/CONTROL	

# 5450 PROFILE

5000 Series



## Cross-section dimensions:

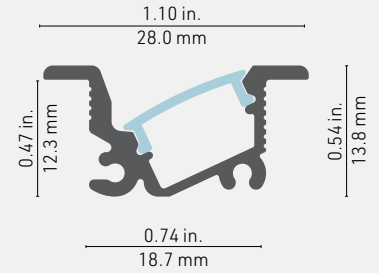

## PERFECT FOR CABINETRY

The 5450 is a **compact recessed LED lighting profile** for cabinetry and other wood furnishing projects, directing the light beam at a **25-degree angle** which allows you to light the cabinet contents from the edge. This profile will **fit in a 5/8 inch** deep recess.

### FEATURES

- Recessed installation inside a 3/4-inch (19mm) wide and 1/2-inch (13mm) deep recess.
- Custom length by sections of 96 inches (2.44m).
- Made of ALCOA 6063-T5 aluminum alloy increasing heat dissipation.
- Its use increases the lifetime of your LED engine.
- Designed to meet North American woodworking standards.

### OPTIONS







### LED ENGINE COMPATIBILITY

IP22: Compatible with LED engines up to **10mm** wide.

### LINEAR WEIGHT

0.163 lbs/ft, 0.242 kg/m (without lens)

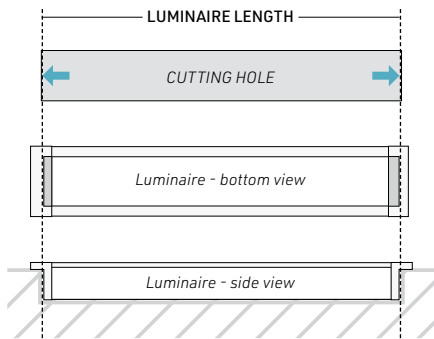

PROFILE	LENSES	LENGTH
 <p>5450 - 5450 Profile, alu</p>	 <p>OP - Opal lens</p>  <p>PR - Prime lens</p>  <p>NO - No lens</p>	<p>Custom length by sections of 2 to 96 inches (2.44m).</p> <p><b>*NOTE:</b> Follow this diagram to calculate the correct length</p> 
<div style="border: 1px solid black; padding: 5px; display: inline-block;"><b>5450</b></div> <small>PROFILE</small>	<div style="border: 1px solid black; width: 100px; height: 15px; display: inline-block;"></div> <small>LENS</small>	<div style="border: 1px solid black; width: 100px; height: 15px; display: inline-block;"></div> <small>LENGTH</small>

5000

COLOR TEMPERATURE	LUMEN PACKAGE*	LEAD IN/OUT	USAGE	POWER SUPPLY/CONTROL	*NOTES
<ul style="list-style-type: none"> <li><span style="display: inline-block; width: 15px; height: 10px; background-color: #f4a460; border: 1px solid black; margin-right: 5px;"></span> 24 - 2400K</li> <li><span style="display: inline-block; width: 15px; height: 10px; background-color: #f4912e; border: 1px solid black; margin-right: 5px;"></span> 27 - 2700K</li> <li><span style="display: inline-block; width: 15px; height: 10px; background-color: #f48b00; border: 1px solid black; margin-right: 5px;"></span> 30 - 3000K</li> <li><span style="display: inline-block; width: 15px; height: 10px; background-color: #f47c00; border: 1px solid black; margin-right: 5px;"></span> 35 - 3500K</li> <li><span style="display: inline-block; width: 15px; height: 10px; background-color: #f46d00; border: 1px solid black; margin-right: 5px;"></span> 42 - 4200K</li> <li><span style="display: inline-block; width: 15px; height: 10px; background-color: #f45e00; border: 1px solid black; margin-right: 5px;"></span> 53 - 5300K (LHP only)</li> <li><span style="display: inline-block; width: 15px; height: 10px; background-color: #f44f00; border: 1px solid black; margin-right: 5px;"></span> 62 - 6200K (LP only)</li> <li><span style="display: inline-block; width: 15px; height: 10px; background-color: #f44000; border: 1px solid black; margin-right: 5px;"></span> WD1 - WarmDim 14W</li> <li><span style="display: inline-block; width: 15px; height: 10px; background-color: #f43100; border: 1px solid black; margin-right: 5px;"></span> TW1 - Tunable White 11W</li> <li><span style="display: inline-block; width: 15px; height: 10px; background-color: #f42200; border: 1px solid black; margin-right: 5px;"></span> TW2 - Tunable White 19W</li> <li><span style="display: inline-block; width: 15px; height: 10px; background-color: #f41300; border: 1px solid black; margin-right: 5px;"></span> RGB1 - RGB 14W</li> <li><span style="display: inline-block; width: 15px; height: 10px; background-color: #f40400; border: 1px solid black; margin-right: 5px;"></span> RGB2 - RGB 19W</li> </ul>	<p>LP0 - 128 LM / 1.5W FT / 90+CRI</p> <p>LP1 - 160 LM / 1.5W FT / 90+CRI</p> <p>LP2 - 255 LM / 3.0W FT / 90+CRI</p> <p>LP3 - 308 LM / 4.5W FT / 90+CRI</p> <p>LP4 - 400 LM / 5.8W FT / 90+CRI</p> <p>LHP - 700 LM / 7.0W FT / 95+CRI</p> <p><b>Note:</b> Not applicable for Warmdim, Tunable White and RGB color temperatures</p>	<p>HW3 - Hardwire 3 FT</p> <p>HW6 - Hardwire 6 FT</p> <p>HW9 - Hardwire 9 FT</p> <p>HWX - Hardwire custom FT</p> <p>NO - No lead</p>	<p>I - IP22 indoor dry location</p>	<p>A - Non-dimming</p> <p>B - ELV dimming 120V AC</p> <p>C - ELV dimming 120/277 VAC**</p> <p>D - 0/10V dimming 120/277 VAC</p> <p>E - Non-dimming DC plug in</p> <p>F - DMX</p> <p>G - Lutron - HI-LUME PREMIER 0,1% Eco System 24V/96W</p> <p>I - Casambi CBU-A2D-0/10V-DALI-Bluetooth 100/277 VAC</p> <p>J - Casambi CBU-PWM4-4CH-Bluetooth 100/277 VAC</p> <p>K - Casambi CBU-TED-CV-Trail edge dim-Bluetooth 120 VAC</p> <p>NO - No driver</p>	<p>*The light output is provided in lumens per foot, for a CCT of 4200K and a clear lens. Please refer to the optics page for CCT and translucency conversion factors.</p> <p>** Only available in 96W - 24V Driver</p> <div style="border: 1px solid black; padding: 2px; display: inline-block; text-align: center;"> <p><b>TITLE</b></p> <p><b>24</b></p> <p><small>DATE: 08/2020</small></p> </div>
<small>COLOR TEMPERATURE CCT</small>	<small>LUMEN PACKAGE</small>	<small>LEAD IN    LEAD OUT</small>	<small>USAGE</small>	<small>POWER SUPPLY/CONTROL</small>	

# 5560 PROFILE

5000 Series



## Cross-section dimensions:

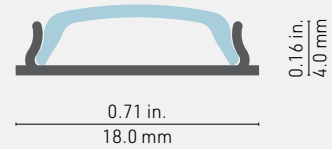

## INSTALLS ON CURVED OR UNEVEN SURFACES!

The 5560 profile allows integrating linear LED lighting on **curved or uneven surfaces**. Its low profile (1/5" including lens), and a thickness of less than 1/32" (0.75mm), allows for **effortless bending and installation** using plain mounting tape.

### FEATURES

- Custom length by sections of 96 inches (2.44m).
- Thin, lightweight and flexible, can be easily bent over curved or uneven surfaces.
- Can be installed using adhesives/mounting tape.
- Made of ALCOA 6063-T5 aluminum alloy, increasing heat dissipation and the lifetime of your LED engine.
- Designed to meet North American woodworking standards.

### OPTIONS







### LED ENGINE COMPATIBILITY

Compatible with LED engines up to **12mm** wide.















### LINEAR WEIGHT

0.033 lbs/ft, 0.049 kg/m (without lens)



PROFILE	LENSES	MOUNTING HARDWARE	LENGTH
 <b>5560</b> - 5560 Profile, alu	 <b>OP</b> - Opal lens   <b>NO</b> - No lens	 <b>3M</b> - Mounting tape, double face   <b>NO</b> - No mounting hardware	Custom length by sections of 2 to 96 inches (2.44m).
<b>5560</b>			
PROFILE	LENS	MOUNTING HARDWARE	LENGTH

5000

COLOR TEMPERATURE	LUMEN PACKAGE*	LEAD IN/OUT	USAGE	POWER SUPPLY/CONTROL	*NOTES
<ul style="list-style-type: none"> <li> <b>24</b> - 2400K</li> <li> <b>27</b> - 2700K</li> <li> <b>30</b> - 3000K</li> <li> <b>35</b> - 3500K</li> <li> <b>42</b> - 4200K</li> <li> <b>53</b> - 5300K (LHP only)</li> <li> <b>62</b> - 6200K (LP only)</li> <li> <b>WD1</b> - WarmDim 14W</li> <li> <b>WD2</b> - WarmDim 17W</li> <li> <b>TW1</b> - Tunable White 11W</li> <li> <b>TW2</b> - Tunable White 19W</li> <li> <b>RGB1</b> - RGB 14W</li> <li> <b>RGB2</b> - RGB 19W</li> <li> <b>RGBW1</b> - 3000K</li> <li> <b>RGBW2</b> - 3000K 4in1</li> </ul>	<ul style="list-style-type: none"> <li><b>LP0</b> - 128 LM / 1.5W FT / 90+CRI</li> <li><b>LP1</b> - 160 LM / 1.5W FT / 90+CRI</li> <li><b>LP2</b> - 255 LM / 3.0W FT / 90+CRI</li> <li><b>LP3</b> - 308 LM / 4.5W FT / 90+CRI</li> <li><b>LP4</b> - 400 LM / 5.8W FT / 90+CRI</li> <li><b>LHP</b> - 700 LM / 7.0W FT / 95+CRI</li> </ul> <p><b>Note:</b> Not applicable for Warmdim Tunable White &amp; RGB color temperatures</p>	<ul style="list-style-type: none"> <li><b>HW3</b> - Hardwire 3 FT</li> <li><b>HW6</b> - Hardwire 6 FT</li> <li><b>HW9</b> - Hardwire 9 FT</li> <li><b>HWX</b> - Hardwire custom FT</li> <li><b>DC3</b> - DC plug 3 FT</li> <li><b>DC6</b> - DC plug 6 FT</li> <li><b>DC9</b> - DC plug 9 FT</li> <li><b>DCX</b> - DC plug custom FT</li> <li><b>NO</b> - No lead</li> </ul>	<ul style="list-style-type: none"> <li><b>I</b> - IP22 indoor dry location</li> </ul>	<ul style="list-style-type: none"> <li><b>A</b> - Non-dimming</li> <li><b>B</b> - ELV dimming 120V AC</li> <li><b>C</b> - ELV dimming 120/277 VAC**</li> <li><b>D</b> - 0/10V dimming 120/277 VAC</li> <li><b>E</b> - Non-dimming DC plug in</li> <li><b>F</b> - DMX</li> <li><b>G</b> - Lutron - HI-LUME PREMIER 0,1% Eco System 24V/96W</li> <li><b>I</b> - Casambi CBU-A2D-0/10V-DALI-Bluetooth 100/277 VAC</li> <li><b>J</b> - Casambi CBU-PWM4-4CH-Bluetooth 100/277 VAC</li> <li><b>K</b> - Casambi CBU-TED-CV-Trail edge dim-Bluetooth 120 VAC</li> <li><b>NO</b> - No driver</li> </ul>	<p>*The light output is provided in lumens per foot, for a CCT of 4200K and a clear lens. Please refer to the optics page for CCT and translucency conversion factors.</p> <p>** Only available in 96W - 24V Driver</p> <div style="border: 1px solid black; padding: 5px; width: fit-content;"> <p>TITLE <b>24</b> COMPLIANCE</p> </div>
COLOR TEMPERATURE CCT	LUMEN PACKAGE	LEAD IN LEAD OUT	USAGE	POWER SUPPLY/CONTROL	

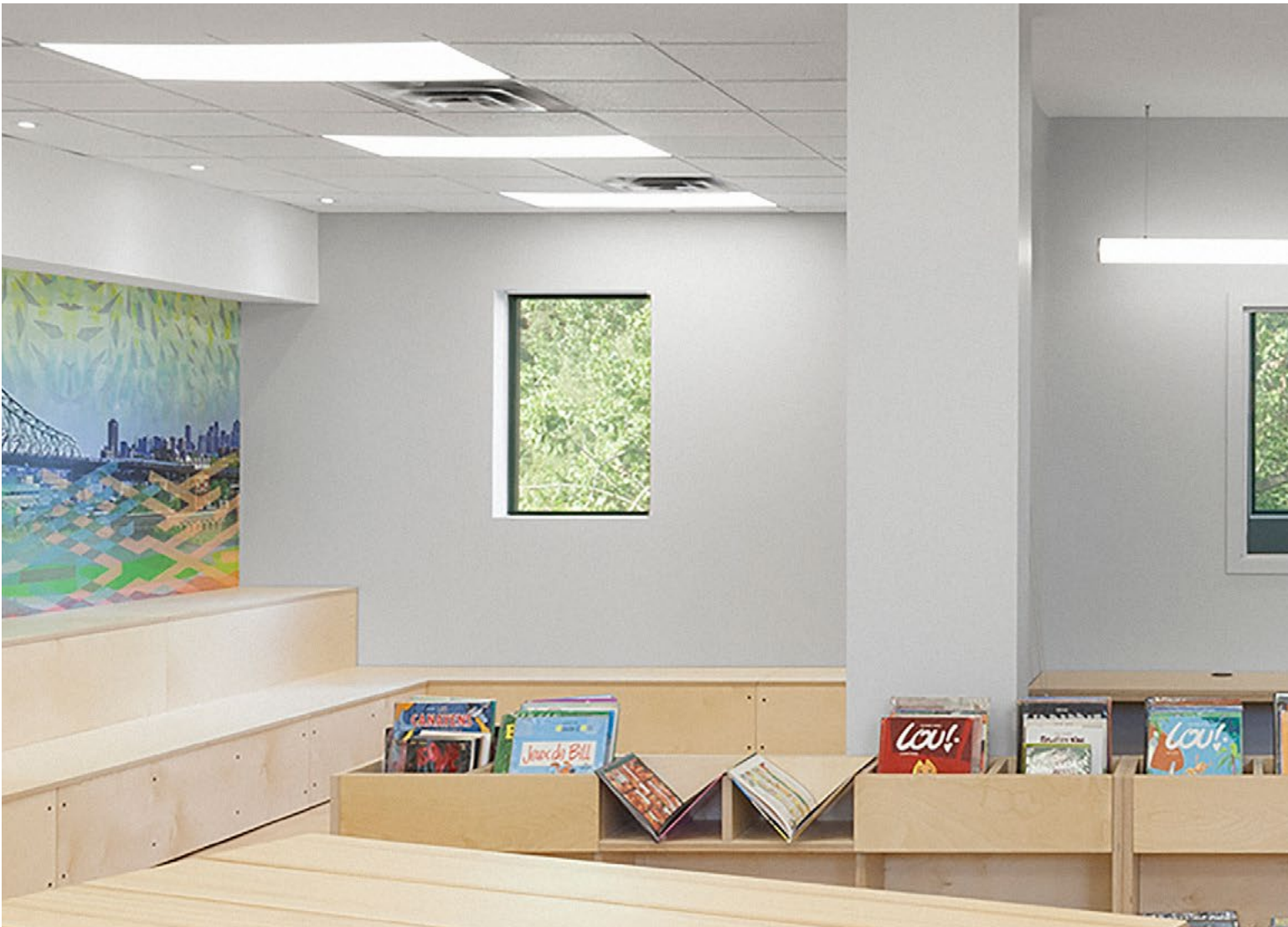

## 7000 SERIES





MULTIMÉDIA

Maa

RWANDA 1994

Saula

Zombikérum  
X-MEN

POLICIERS

Sole D'été

# 7400 (7420) PROFILE

7000 Series

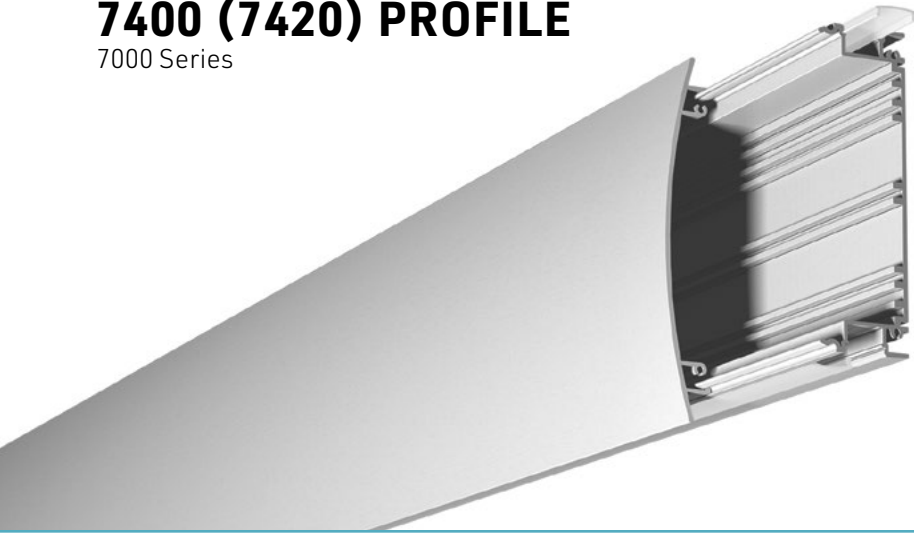

## Cross-section dimensions:

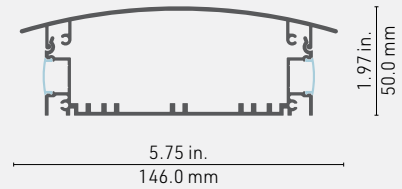

Make customized **modern wall fixtures** with our **7400 profile and the 7420 faceplate**. It accepts most LED engines and lenses of the 1000 Series, offering multiple lighting possibilities. Besides lighting the wall up and down, you could vary the light intensity and color.

## FEATURES

- Compatible with 1000 Series lenses.
- Can be installed in 20 foot lengths.
- Custom length by sections of 6 to 240 inches (6m).
- Application guide for 10mm (3/8-inch) LED engine or less in top and bottom insert.
- Made of ALCOA 6063-T5 aluminum alloy increasing heat dissipation.
- Designed to meet North American woodworking standards.

## OPTIONS



## LED ENGINE COMPATIBILITY







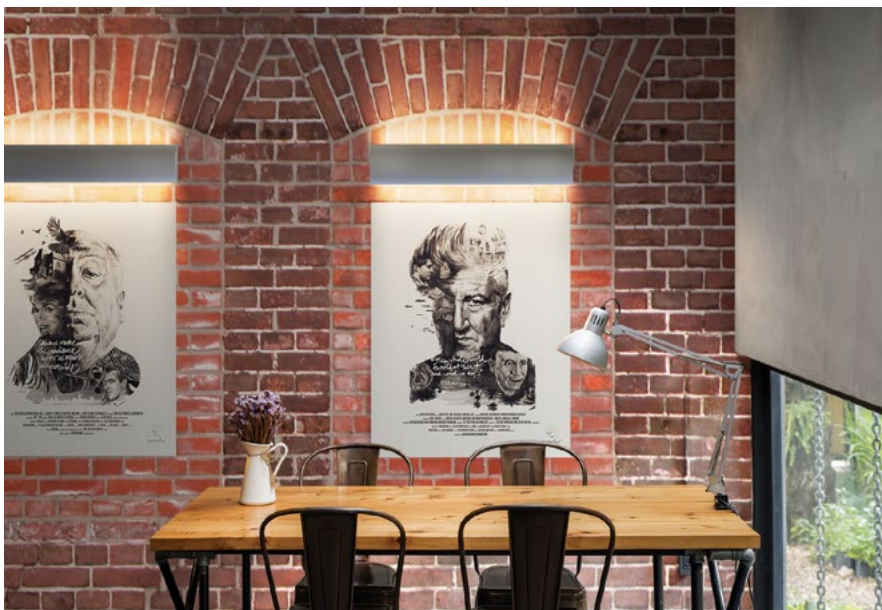



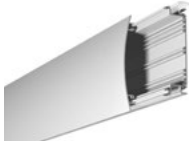



The top and bottom inserts are compatible with LED engines up to **14mm** wide for IP22 and up to **10mm** wide for IP68 options.

## LINEAR WEIGHT



1.617 lbs/ft, 2.406 kg/m (with cover plate)



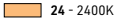
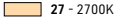
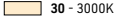
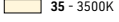
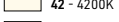
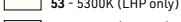
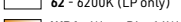
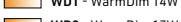
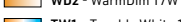
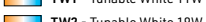
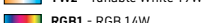
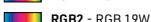

PROFILE	LENS DOWN	LENS UP	LENGTH
 <p>7420 - Series 7400, alu</p>	 <p>CL - Clear lens</p>  <p>SP - Spread lens</p>  <p>OX - Optiflex lens</p>  <p>OP - Opal lens</p>  <p>PR - Prime lens</p>  <p>FO - Focus lens</p>  <p>NO - No lens</p>	 <p>CL - Clear lens</p>  <p>SP - Spread lens</p>  <p>OX - Optiflex lens</p>  <p>OP - Opal lens</p>  <p>PR - Prime lens</p>  <p>FO - Focus lens</p>  <p>NO - No lens</p>	<p>Custom length by sections of 6 to 240 inches (6m).</p> <p><b>*NOTES</b></p> <ul style="list-style-type: none"> <li>- By default CNC-machined junction box openings are made to match standard octagonal junction box in the center of the backplate of the aluminum profile. For custom options, please contact your local representative.</li> <li>- Drivers are remote</li> </ul>
<b>7420</b>			
PROFILE	LENS DOWN	LENS UP	LENGTH

7000

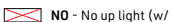
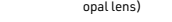
COLOR TEMPERATURE	LM PACKAGE DOWN/UP*	LEAD IN/OUT	USAGE	POWERSUPPLY/CONTROL**	*NOTES		
<p> 24 - 2400K</p> <p> 27 - 2700K</p> <p> 30 - 3000K</p> <p> 35 - 3500K</p> <p> 42 - 4200K</p> <p> 53 - 5300K (LHP only)</p> <p> 62 - 6200K (LP only)</p> <p> WD1 - WarmDim 14W</p> <p> WD2 - WarmDim 17W</p> <p> TW1 - Tunable White 11W</p> <p> TW2 - Tunable White 19W</p> <p> RGB1 - RGB 14W</p> <p> RGB2 - RGB 19W</p> <p> RGBW1 - 3000K</p> <p> RGBW2 - 3000K 4in1</p> <p> NO - No up light (w/ opal lens)</p>	<p>LP0 - 128 LM / 1.5W FT / 90+CRI</p> <p>LP1 - 160 LM / 1.5W FT / 90+CRI</p> <p>LP2 - 255 LM / 3.0W FT / 90+CRI</p> <p>LP3 - 308 LM / 4.5W FT / 90+CRI</p> <p>LP4 - 400 LM / 5.8W FT / 90+CRI</p> <p>LHP - 700 LM / 7.0W FT / 95+CRI</p> <p>NO - No up light (w/ opal lens)</p> <p>Note: Not applicable for Warmdim Tunable White &amp; RGB color temperatures</p>	<p>HW3 - Hardwire 3 FT</p> <p>HW6 - Hardwire 6 FT</p> <p>HW9 - Hardwire 9 FT</p> <p>HWX - Hardwire custom FT</p> <p>DC3 - DC plug 3 FT</p> <p>DC6 - DC plug 6 FT</p> <p>DC9 - DC plug 9 FT</p> <p>DCX - DC plug custom FT</p> <p>NO - No lead</p>	<p>I - IP22 indoor dry location</p> <p>O - IP68 wet/damp location</p>	<p>A - Non-dimming</p> <p>B - ELV dimming 120V AC</p> <p>C - ELV dimming 120/277 VAC***</p> <p>D - 0/10V dimming 120/277 VAC</p> <p>E - Non-dimming DC plug in</p> <p>F - DMX</p> <p>G - Lutron - HI-LUME PREMIER 0,1% Eco System 24V/96W</p> <p>I - Casambi CBU-A2D-0/10V-DALI-Bluetooth 100/277 VAC</p> <p>J - Casambi CBU-PWM4-4CH-Bluetooth 100/277 VAC</p> <p>K - Casambi CBU-TED-CV-Trail edge dim-Bluetooth 120 VAC</p> <p>NO - No driver</p>	<p>* The light output is provided in lumens per foot, for a CCT of 4200K and a clear lens. Please refer to the optics page for CCT and translucency conversion factors.</p> <p>** By default both Up &amp; Down LED engines are controlled from one source. For custom options, please contact your local representative.</p> <p>***Only available in 96W - 24W Driver</p>		
CCT DOWN	CCT UP	LM DOWN	LM UP	LEAD IN	LEAD OUT	USAGE	POWER SUPPLY/CONTROL



# 7400 (7450) PROFILE

7000 Series

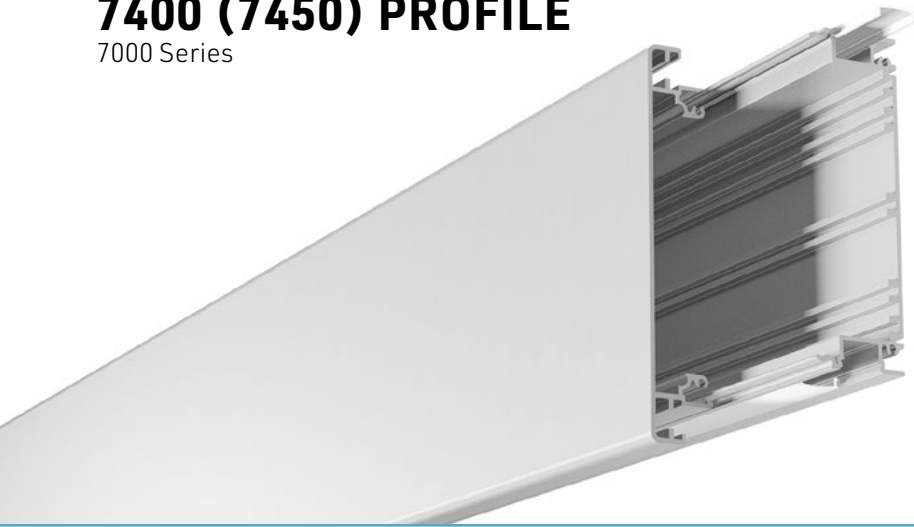

## Cross-section dimensions:

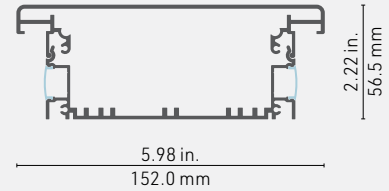

From **flat wall fixtures** to **one-of-a-kind signage**, the 7400 profile with the 7450 faceplate can do it all. The 7400 base accepts most LED engines and lenses of the 1000 Series. The faceplate can be CNC- machined and backlit through an acrylic screen for effective designer signage. Go up to 20 feet long, and finish as desired.

## FEATURES

- Designed to create custom lit nameplates / logo signs.
- Compatible with 1000 Series lenses.
- Can be installed in 20 foot lengths.
- Custom length by sections of 6 to 240 inches (6m).
- Application guide for 10mm (3/8-inch) LED engine or less in top and bottom insert.
- Made of ALCOA 6063-T5 aluminum alloy increasing heat dissipation.
- Designed to meet North American woodworking standards.
- NOTE: Cannot be used for emergency lighting.

## OPTIONS













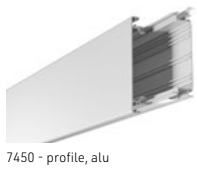
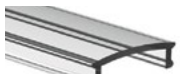
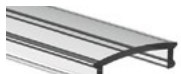

## LED ENGINE COMPATIBILITY

The top and bottom inserts are compatible with LED engines up to **14mm** wide for IP22 and up to **10mm** wide for IP68 options.

## LINEAR WEIGHT

1.949 lbs/ft, 2.901 kg/m (with cover plate)



PROFILE	LENS DOWN	LENS UP	LENGTH
 7450 - profile, atu	 CL - Clear lens	 CL - Clear lens	Custom length by sections of 6 to 240 inches (6m).
	 SP - Spread lens	 SP - Spread lens	
	 OX - Optiflex lens	 OX - Optiflex lens	
	 OP - Opal lens	 OP - Opal lens	
	 PR - Prime lens	 PR - Prime lens	
	 FO - Focus lens	 FO - Focus lens	
	 NO - No lens	 NO - No lens	

















**\*NOTES**

- By default CNC-machined junction box openings are made to match standard octagonal junction box in the center of the backplate of the aluminum profile. For custom options, please contact your local representative.

- Drivers are remote  
- To carve your logo on the front cover of the profile, please contact your local representative and submit the logo image in vector format to:

[support@lumentruss.com](mailto:support@lumentruss.com)

<b>7450</b>			
PROFILE	LENS DOWN	LENS UP	LENGTH

COLOR TEMPERATURE	LM PACKAGE DOWN/UP*	LEAD IN/OUT	USAGE	POWERSUPPLY/CONTROL**	*NOTES
<ul style="list-style-type: none"> <li> 24 - 2400K</li> <li> 27 - 2700K</li> <li> 30 - 3000K</li> <li> 35 - 3500K</li> <li> 42 - 4200K</li> <li> 53 - 5300K (LHP only)</li> <li> 62 - 6200K (LP only)</li> <li> WD1 - WarmDim 14W</li> <li> WD2 - WarmDim 17W</li> <li> TW1 - Tunable White 11W</li> <li> TW2 - Tunable White 19W</li> <li> RGB1 - RGB 14W</li> <li> RGB2 - RGB 19W</li> <li> RGBW1 - 3000K</li> <li> RGBW2 - 3000K 4in1</li> <li> NO - No up light (w/ opal lens)</li> </ul>	<ul style="list-style-type: none"> <li>LP0 - 128 LM / 1.5W FT / 90+CRI</li> <li>LP1 - 160 LM / 1.5W FT / 90+CRI</li> <li>LP2 - 255 LM / 3.0W FT / 90+CRI</li> <li>LP3 - 308 LM / 4.5W FT / 90+CRI</li> <li>LP4 - 400 LM / 5.8W FT / 90+CRI</li> <li>LHP - 700 LM / 7.0W FT / 95+CRI</li> <li>NO - No up light (w/ opal lens)</li> </ul> <p>Note: Not applicable for Warmdim Tunable White &amp; RGB color temperatures</p>	<ul style="list-style-type: none"> <li>HW3 - Hardwire 3 FT</li> <li>HW6 - Hardwire 6 FT</li> <li>HW9 - Hardwire 9 FT</li> <li>HWX - Hardwire custom FT</li> <li>DC3 - DC plug 3 FT</li> <li>DC6 - DC plug 6 FT</li> <li>DC9 - DC plug 9 FT</li> <li>DCX - DC plug custom FT</li> <li>NO - No lead</li> </ul>	<ul style="list-style-type: none"> <li>I - IP22 indoor dry location</li> <li>O - IP68 wet/damp location</li> </ul>	<ul style="list-style-type: none"> <li>A - Non-dimming</li> <li>B - ELV dimming 120V AC</li> <li>C - ELV dimming 120/277 VAC***</li> <li>D - 0/10V dimming 120/277 VAC</li> <li>E - Non-dimming DC plug in</li> <li>F - DMX</li> <li>G - Lutron - HI-LUME PREMIER 0,1% Eco System 24V/96W</li> <li>I - Casambi CBU-A2D-0/10V-DALI-Bluetooth 100/277 VAC</li> <li>J - Casambi CBU-PWM4-4CH-Bluetooth 100/277 VAC</li> <li>K - Casambi CBU-TED-CV-Trail edge dim-Bluetooth 120 VAC</li> <li>NO - No driver</li> </ul>	<ul style="list-style-type: none"> <li>* The light output is provided in lumens per foot, for a CCT of 4200K and a clear lens. Please refer to the optics page for CCT and translucency conversion factors.</li> <li>** By default both Up &amp; Down LED engines are controlled from one source. For custom options, please contact your local representative.</li> <li>***Only available in 96W - 24W Driver</li> </ul>

CCT DOWN   CCT UP   LM DOWN   LM UP   LEAD IN   LEAD OUT   USAGE   POWER SUPPLY/CONTROL

# 7500 PROFILE

7000 Series



## Cross-section dimensions:

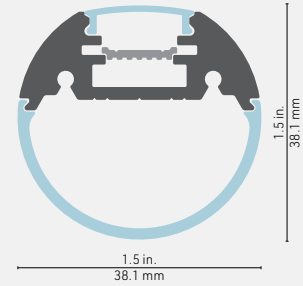

This 7500 series has direct, indirect or combined lighting options. Combining style and **elegance in a beautiful round format**, the 7500 profile is designed to be a suspended fixture with different and independent lumen package for both lighting options to achieve a wide variety of looks and lighting effects. This charming light fixture, is perfect for your project in either residential or commercial applications.

## FEATURES

- Customizable lengths by sections from 2 to 240 inches (6m).
- Designed to give a uniform light without hot spots with a prime lens.
- Large variety of optics allows for greater creativity.
- 2 different suspension options; fixed and pivoting.
- Made of ALCOA 6063 T-5 aluminum alloy increasing heat dissipation.
- Increases the practical life of your LEDs with better heat dissipation.
- Designed to meet North American woodworking standards.

## OPTIONS





























## LED ENGINE COMPATIBILITY

Compatible with LED engines up to **12mm** wide.

## LINEAR WEIGHT

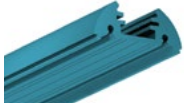
0.433 lbs/ft, 0.644 kg/m (without lens)



PROFILE	LENS DOWN	LENS UP	MOUNTING HARDWARE	CANOPY	LENGTH
 <p>7500 - 7500 Profile, alu</p>	 <p>OX - Optiflex lens</p>	 <p>CL - Clear lens</p>	 <p>SUS - Suspension kit with 15ft. aircraft cable</p>	<p><b>NOTE:</b> Only available with <b>SUS</b> bracket (suspension)</p>  <p>Remote driver canopy plate See Appendix 2 on page 158 CR0 - Alu CR1 - Black CR2 - White</p>	<p>Custom length by sections of 2 to 96"</p> <p>Swivel maximum length = 72"</p>
 <p>7501 - 7500 Profile, black</p>	 <p>PR - Prime lens</p>	 <p>SP - Spread lens</p>	 <p>Suspension swivel kit with 15ft. aircraft cable</p>	 <p>Integrated driver in canopy See Appendix 2 on page 158 C10 - Alu C11 - Black C12 - White</p>	
 <p>7502 - 7500 Profile, white</p>	 <p>NO - No lens</p>	 <p>OX - Optiflex lens</p>	 <p>SWRD - Red loop</p>  <p>SWPK - Pink loop</p>  <p>SWCY - Cyan loop</p>  <p>SWBK - Black loop</p>  <p>SWBL - Blue loop</p>  <p>SWWH - White loop</p>  <p>SWGR - Green loop</p>  <p>SWTR - Transparent loop</p>  <p>SWOR - Orange loop</p>	 <p>Integrated driver &amp; suspension kit See Appendix 2 on page 158 CIK0 - Alu CIK1 - Black CIK2 - White</p>	
 <p>750X - 7500 Profile, custom color</p> <p><b>IMPORTANT:</b> Give RAL color No See Appendix 1 on page 158</p>	 <p>NO - No lens</p>	 <p>OP - Opal lens</p>	 <p>NO - No lens</p>	 <p>NO - No canopy</p>	
RAL NUMBER					
PROFILE	LENS DOWN	LENS UP	MOUNTING HARDWARE	CANOPY	LENGTH

COLOR TEMPERATURE	LM PACKAGE DOWN/UP*	POWER CABLE FINISH	USAGE	POWERSUPPLY/CONTROL**	*NOTES	
<p>24 - 2400K</p> <p>27 - 2700K</p> <p>30 - 3000K</p> <p>35 - 3500K</p> <p>42 - 4200K</p> <p>53 - 5300K (LHP only)</p> <p>62 - 6200K (LP only)</p> <p>WD1 - WarmDim 14W</p> <p>WD2 - WarmDim 17W</p> <p>TW1 - Tunable White 11W</p> <p>TW2 - Tunable White 19W</p> <p>RGB1 - RGB 14W</p> <p>RGB2 - RGB 19W</p> <p>RGBW1 - 3000K</p> <p>RGBW2 - 3000K 4in1</p> <p>NO - No up light (w/ opal lens)</p>	<p>LP0 - 128 LM / 1.5W FT / 90+CRI</p> <p>LP1 - 160 LM / 1.5W FT / 90+CRI</p> <p>LP2 - 255 LM / 3.0W FT / 90+CRI</p> <p>LP3 - 308 LM / 4.5W FT / 90+CRI</p> <p>LP4 - 400 LM / 5.8W FT / 90+CRI</p> <p>LHP - 700 LM / 7.0W FT / 95+CRI</p> <p>NO - No up light (w/ opal lens)</p> <p><b>Note:</b> Not applicable for Warmdim Tunable White &amp; RGB color temperatures</p>	<p>BK - Black</p> <p>WH - White</p> <p>RD - Red</p> <p>BC - Black/White Chevron</p>	<p>I - IP22 indoor dry location</p>	<p>A - Non-dimming</p> <p>B - ELV dimming 120V AC</p> <p>C - ELV dimming 120/277 VAC***</p> <p>D - 0/10V dimming 120/277 VAC</p> <p>E - Non-dimming DC plug in</p> <p>F - DMX</p> <p>G - Lutron - HI-LUME PREMIER 0,1% Eco System 24V/96W</p> <p>I - Casambi CBU-A2D-0/10V-DALI-Bluetooth 100/277 VAC</p> <p>J - Casambi CBU-PWM4-4CH-Bluetooth 100/277 VAC</p> <p>K - Casambi CBU-TED-CV-Trail edge dim-Bluetooth 120 VAC</p> <p>NO - No driver</p>	<p>* The light output is provided in lumens per foot, for a CCT of 4200K and a clear lens. Please refer to the optics page for CCT and translucency conversion factors.</p> <p>** By default both Up &amp; Down LED engines are controlled from one source. For custom options, please contact your local representative.</p> <p>***Only available in 96W - 24W Driver</p>	
CCT DOWN	CCT UP	LM DOWN	LM UP	POWER CABLE FINISH	USAGE	POWER SUPPLY/CONTROL

# 7650 PROFILE (TUBE)

HORIZONTAL SUSPENSION / WALL MOUNT

7000 Series

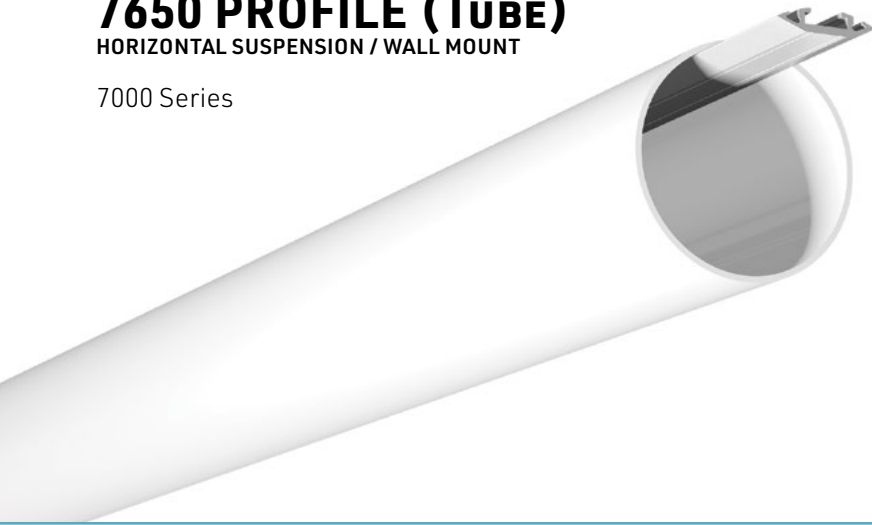

Cross-section dimensions:

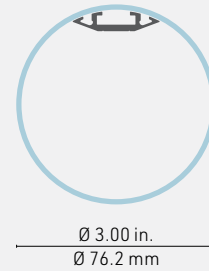

## THE BEAUTY OF 315 ° LIGHTING

Modern design, this beautiful opal acrylic tube multiplies the possibilities of lighting. An innovative three-sided radiator diffuses light at 315° and can accommodate 2 or 3 light sources. The wide choice of color temperatures and light intensities make it an ultra-versatile luminaire when it comes to determining the intensity and color of the light. With a 3-inch diameter, the 7650 provides uniform linear illumination without dots or halos.

### FEATURES

- **Surface Installation:** Can be installed horizontally with 2 stylish canopies or vertically with a stylish canopy, and an electrical junction box. Given the lightness of the tube, the facades of the stylish canopy can be mounted in three positions: top, center and bottom.
- **Horizontal Hanging Installation:** Create striking lighting effects by varying angles or arranging tubes asymmetrically. Choice of 3 standard light sources and 3 24V high power light sources on one, two or three radiator trays providing 6 light intensity options.
- Custom length by sections of 6 to 144 inches (3.6m).
- Accepts 3 LED engines on the heatsink insert
- Designed to give a uniform light without hot spots.
- Designed to meet North American woodworking standards.

### OPTIONS



### LED ENGINE COMPATIBILITY

All three surfaces of the heatsink insert are compatible with LED engines up to **10mm** wide for IP22 and up to **8mm** wide for IP68 options.

### LINEAR WEIGHT

0.529 lbs/ft, 0.787 kg/m (acrylic tube with aluminum heatsink insert only)



**ACRYLIC DIFFUSER**



**7650** - Acrylic diffuser tube

**HEATSINK INSERT**



**1900** - Edge heatsink

**MOUNTING HARDWARE**



**SUSH** - Horiz. susp. kit, Alu (Type B single channel) w/15ft. aircraft cable



**MC** - Mural canopy, alu  
*NOTE: This mural canopy requires a remote driver.*

**CANOPY**

**NOTE:** Only available with **SUS** bracket (suspension)



**Remote driver canopy plate**  
See Appendix 2 on page 158  
**CR0** - Alu  
**CR1** - Black  
**CR2** - White



**Integrated driver in canopy**  
See Appendix 2 on page 158  
**CI0** - Alu  
**CI1** - Black  
**CI2** - White



**Integrated driver & suspension kit**  
See Appendix 2 on page 158  
**CIK0** - Alu  
**CIK1** - Black  
**CIK2** - White



**NO** - No canopy

**LENGTH**

Custom length by sections of 6 to 144 inches (3.6 m).

















**7650**  
ACRYLIC DIFFUSER

**1900**  
HEATSINK INSERT

MOUNTING HARDWARE

CANOPY

LENGTH

COLOR TEMPERATURE	LUMEN PACKAGE*	LEAD IN/OUT	POWER CABLE FINISH	USAGE*	POWER SUPPLY/CONTROL
<ul style="list-style-type: none"> <li> <b>24</b> - 2400K</li> <li> <b>27</b> - 2700K</li> <li> <b>30</b> - 3000K</li> <li> <b>35</b> - 3500K</li> <li> <b>42</b> - 4200K</li> <li> <b>53</b> - 5300K (LHP only)</li> <li> <b>62</b> - 6200K (LP only)</li> <li> <b>WD1</b> - WarmDim 14W</li> <li> <b>TW1</b> - Tunable White 11W</li> <li> <b>TW2</b> - Tunable White 19W</li> <li> <b>RGB1</b> - RGB 14W</li> <li> <b>RGB2</b> - RGB 19W</li> </ul>	<ul style="list-style-type: none"> <li><b>2LP1</b> - 320 LM / 3.0W FT / 90+CRI</li> <li><b>2LP3</b> - 616 LM / 9.0W FT / 90+CRI</li> <li><b>3LP2</b> - 765 LM / 9.0W FT / 90+CRI</li> <li><b>3LP3</b> - 924 LM / 13.5W FT / 90+CRI</li> <li><b>2LHP</b> - 1400 LM / 14.0W FT / 90+CRI</li> <li><b>3LHP</b> - 2100 LM / 21.0W FT / 95+CRI</li> </ul> <p><b>Note:</b> Not applicable for Warmdim Tunable White &amp; RGB color temperatures</p>	<ul style="list-style-type: none"> <li><b>HW3</b> - Hardwire 3 FT</li> <li><b>HW6</b> - Hardwire 6 FT</li> <li><b>HW9</b> - Hardwire 9 FT</li> <li><b>HWX</b> - Hardwire custom FT</li> <li><b>DC3</b> - DC plug 3 FT</li> <li><b>DC6</b> - DC plug 6 FT</li> <li><b>DC9</b> - DC plug 9 FT</li> <li><b>DCX</b> - DC plug custom FT</li> <li><b>SUS</b> - Coaxial wire 15 FT</li> <li><b>NO</b> - No lead</li> </ul>	<ul style="list-style-type: none"> <li> <b>BK</b> - Black</li> <li> <b>WH</b> - White</li> <li> <b>RD</b> - Red</li> <li> <b>BC</b> - Black/White Chevron</li> </ul>	<ul style="list-style-type: none"> <li><b>I</b> - IP22 indoor dry location</li> <li><b>0</b> - IP68 wet/damp location</li> </ul>	<ul style="list-style-type: none"> <li><b>A</b> - Non-dimming</li> <li><b>B</b> - ELV dimming 120V AC</li> <li><b>C</b> - ELV dimming 120/277 VAC**</li> <li><b>D</b> - 0/10V dimming 120/277 VAC</li> <li><b>E</b> - Non-dimming DC plug in</li> <li><b>F</b> - DMX</li> <li><b>G</b> - Lutron - HI-LUME PREMIER 0,1% Eco System 24V/96W</li> <li><b>I</b> - Casambi CBU-A2D-0/10V-DALI-Bluetooth 100/277 VAC</li> <li><b>J</b> - Casambi CBU-PWM4-4CH-Bluetooth 100/277 VAC</li> <li><b>K</b> - Casambi CBU-TED-CV-Trail edge dim-Bluetooth 120 VAC</li> <li><b>NO</b> - No driver</li> </ul>
COLOR TEMPERATURE CCT	LUMEN PACKAGE	LEAD IN LEAD OUT	POWER CABLE FINISH	USAGE	POWER SUPPLY/CONTROL

\*NOTE: The light output is provided in lumens per foot, for a CCT of 4200K and a clear lens. Please refer to the optics page for CCT and translucency conversion factors. \*\* Only available in 96W - 24V Driver

# 7650 PROFILE (TUBE)

VERTICAL SUSPENSION

7000 Series



Cross-section dimensions:

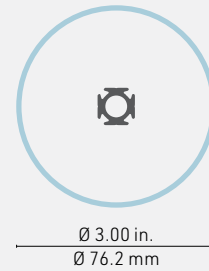

## THE MAGIC OF 360° LIGHTING

Modern design, this beautiful opal acrylic tube multiplies the possibilities of lighting. Its innovative four-sided radiator diffuses 360° light and can accommodate 4 light sources. The wide choice of color temperatures and light intensities make it an ultra-versatile luminaire when it comes to determining the intensity and color of the light. With a 3-inch diameter, the 7650 provides uniform linear illumination without dots or halos.

### FEATURES

- Hanging installation vertically
- Custom length by sections of 6 to 144 inches (3.6m).
- Accepts 4 led engines on the heatsink insert: up to 10mm wide.
- Made of ALCOA 6063-T5 aluminum alloy increasing heat dissipation.
- Designed to give a uniform 360° light without hot spots.
- Designed to meet North American woodworking standards.

### OPTIONS



### LED ENGINE COMPATIBILITY



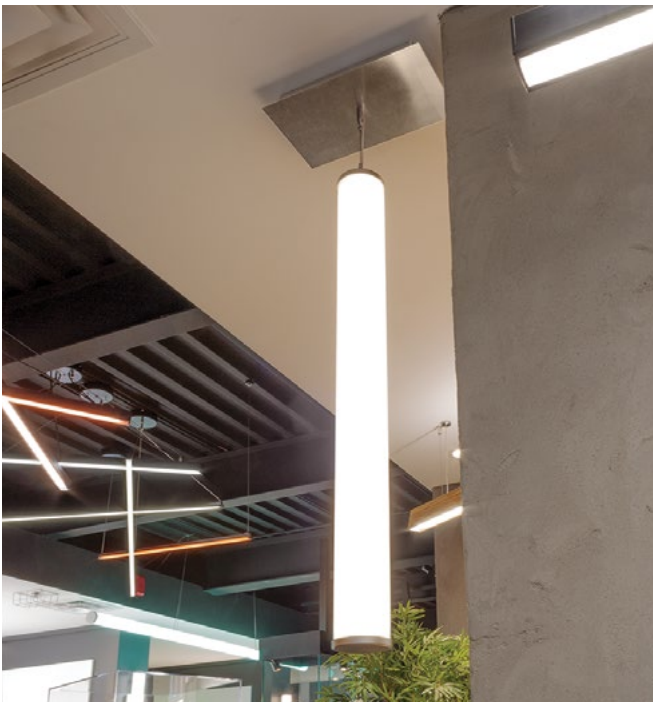

All four surfaces of the heatsink are compatible with LED engines up to **10mm** wide for IP22 and up to **8mm** wide for IP68 options.

### LINEAR WEIGHT

















0.529 lbs/ft, 0.787 kg/m (acrylic tube with aluminum heatsink insert only)





ACRYLIC DIFFUSER	HEATSINK INSERT	MOUNTING HARDWARE	CANOPY	LENGTH
 <p><b>7650</b> - Acrylic diffuser tube</p>	 <p><b>7604</b> - 4-Side heatsink</p>	 <p><b>SUSV</b> - Vert. susp. kit, Chrome w/15ft. aircraft cable &amp; coax wire</p>	 <p><b>NOTE:</b> Only available with <b>SUS</b> bracket (suspension)</p> <p><b>Remote driver canopy plate</b> See Appendix 2 on page 158 <b>CR0</b> - Alu <b>CR1</b> - Black <b>CR2</b> - White</p>	<p>Custom length by sections of 6 to 60 inches.</p> <p><b>NOTE:</b> When using our high voltage LED engine (<b>4LHP</b>), the maximum length is 48 inches.</p>
<b>7650</b>	<b>7604</b>	<b>SUSV</b>		
ACRYLIC DIFFUSER	HEATSINK INSERT	MOUNTING HARDWARE	CANOPY	LENGTH

7000

COLOR TEMPERATURE	LUMEN PACKAGE*	POWER CABLE FINISH	USAGE*	POWER SUPPLY/CONTROL	*NOTES
<ul style="list-style-type: none"> <li> 24 - 2400K</li> <li> 27 - 2700K</li> <li> 30 - 3000K</li> <li> 35 - 3500K</li> <li> 42 - 4200K</li> <li> 53 - 5300K (LHP only)</li> <li> 62 - 6200K (LP only)</li> <li> <b>WD1</b> - WarmDim 14W</li> <li> <b>TW1</b> - Tunable White 11W</li> <li> <b>TW2</b> - Tunable White 19W</li> <li> <b>RGB1</b> - RGB 14W</li> <li> <b>RGB2</b> - RGB 19W</li> </ul>	<ul style="list-style-type: none"> <li><b>4LP0</b> - 512 LM / 6.0W FT / 90+CRI</li> <li><b>4LP1</b> - 640 LM / 6.0W FT / 90+CRI</li> <li><b>4LP2</b> - 1020 LM / 12.0W FT / 90+CRI</li> <li><b>4LP3</b> - 1232 LM / 18.0W FT / 90+CRI</li> <li><b>4LP4</b> - 1600 LM / 23.2W FT / 90+CRI</li> <li><b>4LHP</b> - 2800 LM / 28.0W FT / 95+CRI</li> </ul> <p><b>Note:</b> Not applicable for Warmdim Tunable White &amp; RGB color temperatures</p>	<ul style="list-style-type: none"> <li> <b>BK</b> - Black</li> <li> <b>WH</b> - White</li> <li> <b>RD</b> - Red</li> <li> <b>BC</b> - Black/White Chevron</li> </ul>	<ul style="list-style-type: none"> <li><b>I</b> - IP22 indoor dry location</li> <li><b>0</b> - IP68 wet/damp location</li> </ul>	<ul style="list-style-type: none"> <li><b>A</b> - Non-dimming</li> <li><b>B</b> - ELV dimming 120V AC</li> <li><b>C</b> - ELV dimming 120/277 VAC**</li> <li><b>D</b> - 0/10V dimming 120/277 VAC</li> <li><b>E</b> - Non-dimming DC plug in</li> <li><b>F</b> - DMX</li> <li><b>G</b> - Lutron - HI-LUME PREMIER 0,1% Eco System 24V/96W</li> <li><b>I</b> - Casambi CBU-A2D-0/10V-DALI-Bluetooth 100/277 VAC</li> <li><b>J</b> - Casambi CBU-PWM4-4CH-Bluetooth 100/277 VAC</li> <li><b>K</b> - Casambi CBU-TED-CV-Trail edge dim-Bluetooth 120 VAC</li> <li><b>NO</b> - No driver</li> </ul>	<p>*The light output is provided in lumens per foot, for a CCT of 4200K and a clear lens. Please refer to the optics page for CCT and translucency conversion factors.</p> <p>** Only available in 96W - 24V Driver</p> <div style="border: 1px solid black; padding: 5px; width: fit-content;"> <p><b>TITLE 24</b></p> </div>
COLOR TEMPERATURE CCT	LUMEN PACKAGE	POWER CABLE FINISH	USAGE	POWER SUPPLY/CONTROL	

# 7800 PROFILE (POLETRUSS)

7000 Series



Cross-section dimensions:

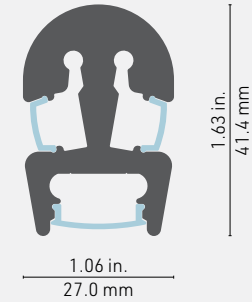

**Illuminate the inside of your closet** to see your entire wardrobe! The 7800 profile is our **most robust closet pole** and offers three lighting possibilities. The rod will accept most LED engines as well as the 1000 and 4000 series lenses. You can even add a touch of woodwork in order to give it a classy appearance.

## FEATURES

- Rugged construction to withstand abuse in a commercial (hotel or retail) setting.
- Compatible with the 1000 and the 4000 series lenses.
- Can be installed in length of 8 feet without additional support.
- Custom length by sections of up to 8 feet (2.44m).
- Application guide for 10mm (3/8-inch) LED engine or less in the bottom insert.
- Made of ALCOA 6063-T5 aluminum alloy increasing heat dissipation.
- Compatible with multiple installation accessories.
- Designed to meet North American woodworking standards.

## OPTIONS

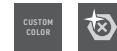









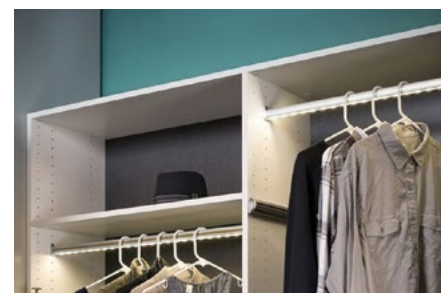







## LED ENGINE COMPATIBILITY

The **bottom channel** is compatible with LED engines up to **14mm** wide for IP22 and up to **10mm** wide for IP68 options, and the **side channels** – with LED engines up to **10mm** wide for IP22 and up to **8mm** wide for IP68 options.

## LINEAR WEIGHT

1.058 lbs/ft, 1.575 kg/m (without lenses)



PROFILE	LENS DOWN (1)	FRONT SIDE (2)	BACK SIDE (3)	MOUNTING HARDWARE	LENGTH
 7800 - Profile, alu	 CL - Clear lens	 CL - Clear lens side	 CL - Clear lens side	 BR0 - endcap / bracket kit, Alu	Custom length by sections of 6 to 96 inches (2.44m).
	 OX - Optiflex lens	 OX - Optiflex lens side	 OX - Optiflex lens side		
	 OP - Opal lens	 OP - Opal lens side	 OP - Opal lens side		
	 PR - Prime lens	 NO - No lens	 NO - No lens		
	 NO - No Lens				

  









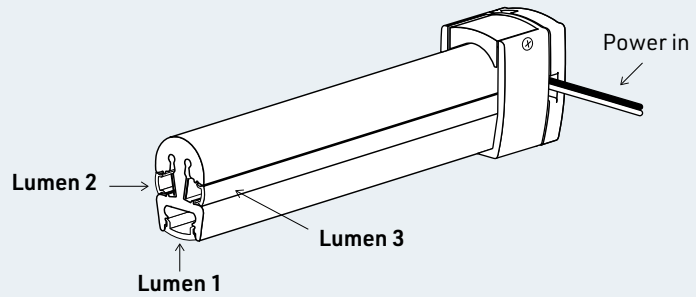







7800				BR0	
PROFILE	BOTTOM LENS (1)	FRONT SIDE (2)	BACK SIDE (3)	MOUNTING HARDWARE	LENGTH

### \*NOTES

By default lenses are the same length as aluminum profile. Customer will need to cut the bottom lens to accommodate the ceiling support (BR2) if required.

\*NOTE: Follow this diagram when selecting the Lumen Package.  
No side strip = Opal lens



COLOR TEMPERATURE	LUMEN PACKAGE*	LEAD IN/OUT	USAGE	POWER SUPPLY/CONTROL	*NOTES
 24 - 2400K	LP0 - 128 LM / 1.5W FT / 90+CRI	HW3 - Hardwire 3 FT	I - IP22 indoor dry location	A - Non-dimming	*The light output is provided in lumens per foot, for a CCT of 4200K and a clear lens. Please refer to the optics page for CCT and translucency conversion factors.  ** Only available in 96W - 24V Driver
 27 - 2700K	LP1 - 160 LM / 1.5W FT / 90+CRI	HW6 - Hardwire 6 FT	O - IP68 wet/damp location	B - ELV dimming 120V AC	
 30 - 3000K	LP2 - 255 LM / 3.0W FT / 90+CRI	HW9 - Hardwire 9 FT		C - ELV dimming 120/277 VAC**	
 35 - 3500K	LP3 - 308 LM / 4.5W FT / 90+CRI	HWX - Hardwire custom FT		D - 0/10V dimming 120/277 VAC	
 42 - 4200K	LP4 - 400 LM / 5.8W FT / 90+CRI	DC3 - DC plug 3 FT		E - Non-dimming DC plug in	
 53 - 5300K (LHP only)	LHP - 700 LM / 7.0W FT / 95+CRI	DC6 - DC plug 6 FT		F - DMX	
 62 - 6200K (LP only)	NO - No side light (w/ opal lens)	DC9 - DC plug 9 FT		G - Lutron - HI-LUME PREMIER 0,1% Eco System 24V/96W	
 WD1 - WarmDim 14W	Note: Not applicable for Warmdim Tunable White & RGB color temperatures	DCX - DC plug custom FT		I - Casambi CBU-A2D-0/10V-DALI-Bluetooth 100/277 VAC	
 WD2 - WarmDim 17W		NO - No lead		J - Casambi CBU-PWM4-4CH-Bluetooth 100/277 VAC	
 TW1 - Tunable White 11W				K - Casambi CBU-TED-CV-Trail edge dim-Bluetooth 120 VAC	
 TW2 - Tunable White 19W				NO - No driver	
 RGB1 - RGB 14W					
 RGB2 - RGB 19W					
 RGBW1 - 3000K					
 RGBW2 - 3000K 4in1					
 NO - No side lights (w/ opal lens)					



CCT1 CCT2 CCT3 LM1 LM2 LM3 LEAD IN LEAD OUT USAGE POWER SUPPLY/CONTROL

# 7850 PROFILE

7000 Series



## Cross-section dimensions:

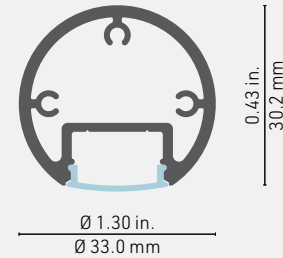

The 7850 is a **direct replacement of standard closet rods, and even curtain rods**. Whether you need to light your way through the morning wardrobe, or turn your sheer curtains into a privacy screen at night, this profile will do the job. This profile can even be used to replace your shower curtain rod when installed with IP68 graded LED engine and power supply suitable for wet locations.

## FEATURES

- Standard diameter for wardrobe rods, compatible with a wide range of hardware on the market.
- Compatible with the 1000 Series lenses.
- Custom length by sections of 6 to 240 inches (6m).
- Application guide for 10mm (3/8-inch) LED engine or less.
- Made of ALCOA 6063-T5 aluminum alloy increasing heat dissipation.
- Designed to meet North American woodworking standards.

## OPTIONS



## LED ENGINE COMPATIBILITY











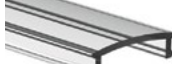





IP22: Compatible with LED engines up to **14mm** wide.

IP68: Compatible with LED engines up to **10mm** wide.

## LINEAR WEIGHT

0.442 lbs/ft, 0.658 kg/m (without lens)



PROFILE	LENSES	MOUNTING HARDWARE	SUPPORT	MOTION SENSORS*	LENGTH
 <p>7850 - Profile, Alu</p>	 <p>CL - Clear lens</p>  <p>SP - Spread lens</p>  <p>OX - Optiflex lens</p>  <p>OP - Opal lens</p>  <p>PR - Prime lens</p> <p> NO - No lens</p>	 <p>BR1 - Heavy duty Closet Rod bracket kit</p>  <p>BR3 - Screwless finish hangers</p>  <p>EC0 - Standard endcaps, Alu.</p> <p> NO - No mounting hardware</p>	 <p>BR2 - Ceiling support (should be ordered at every 48")</p> <p> NO - No support</p>	 <p>SEN1 - 30 sec. Embedded</p>  <p>SEN2 - 30 sec. Outside extrusion</p>  <p>SEN3 - 4 min. Embedded</p>  <p>SEN4 - 4 min. Outside extrusion</p> <p> NO - No sensor</p>	<p>Custom length by sections of 6 to 240 inches (6m).</p>
<b>7850</b>					
PROFILE	LENS	MOUNTING HARDWARE	SUPPORT QTY (every 48")	MOTION SENSOR	LENGTH

**\*NOTES**

All motion sensors: Max 36W/12V or 72W/24V

COLOR TEMPERATURE	LUMEN PACKAGE*	LEAD IN/OUT	USAGE	POWER SUPPLY/CONTROL	*NOTES
<p>24 - 2400K</p> <p>27 - 2700K</p> <p>30 - 3000K</p> <p>35 - 3500K</p> <p>42 - 4200K</p> <p>53 - 5300K (LHP only)</p> <p>62 - 6200K (LP only)</p> <p>WD1 - WarmDim 14W</p> <p>WD2 - WarmDim 17W</p> <p>TW1 - Tunable White 11W</p> <p>TW2 - Tunable White 19W</p> <p>RGB1 - RGB 14W</p> <p>RGB2 - RGB 19W</p> <p>RGBW1 - 3000K</p> <p>RGBW2 - 3000K 4in1</p>	<p>LP0 - 128 LM / 1.5W FT / 90+CRI</p> <p>LP1 - 160 LM / 1.5W FT / 90+CRI</p> <p>LP2 - 255 LM / 3.0W FT / 90+CRI</p> <p>LP3 - 308 LM / 4.5W FT / 90+CRI</p> <p>LP4 - 400 LM / 5.8W FT / 90+CRI</p> <p>LHP - 700 LM / 7.0W FT / 95+CRI</p> <p><b>Note:</b> Not applicable for Warmdim Tunable White &amp; RGB color temperatures</p>	<p>HW3 - Hardwire 3 FT</p> <p>HW6 - Hardwire 6 FT</p> <p>HW9 - Hardwire 9 FT</p> <p>HWX - Hardwire custom FT</p> <p>DC3 - DC plug 3 FT</p> <p>DC6 - DC plug 6 FT</p> <p>DC9 - DC plug 9 FT</p> <p>DCX - DC plug custom FT</p> <p>NO - No lead</p>	<p>I - IP22 indoor dry location</p> <p>O - IP68 wet/damp location</p>	<p>A - Non-dimming</p> <p>B - ELV dimming 120V AC</p> <p>C - ELV dimming 120/277 VAC**</p> <p>D - 0/10V dimming 120/277 VAC</p> <p>E - Non-dimming DC plug in</p> <p>F - DMX</p> <p>G - Lutron - HI-LUME PREMIER 0,1% Eco System 24V/96W</p> <p>I - Casambi CBU-A2D-0/10V-DALI-Bluetooth 100/277 VAC</p> <p>J - Casambi CBU-PWM4-4CH-Bluetooth 100/277 VAC</p> <p>K - Casambi CBU-TED-CV-Trail edge dim-Bluetooth 120 VAC</p> <p>NO - No driver</p>	<p>*The light output is provided in lumens per foot, for a CCT of 4200K and a clear lens. Please refer to the optics page for CCT and translucency conversion factors.</p> <p>** Only available in 96W - 24V Driver</p> <div style="border: 1px solid black; padding: 2px; display: inline-block;"> <p>TITLE <b>24</b> COMPONENTS</p> </div>
COLOR TEMPERATURE CCT	LUMEN PACKAGE	LEAD IN LEAD OUT	USAGE	POWER SUPPLY/CONTROL	



# 8000 SERIES

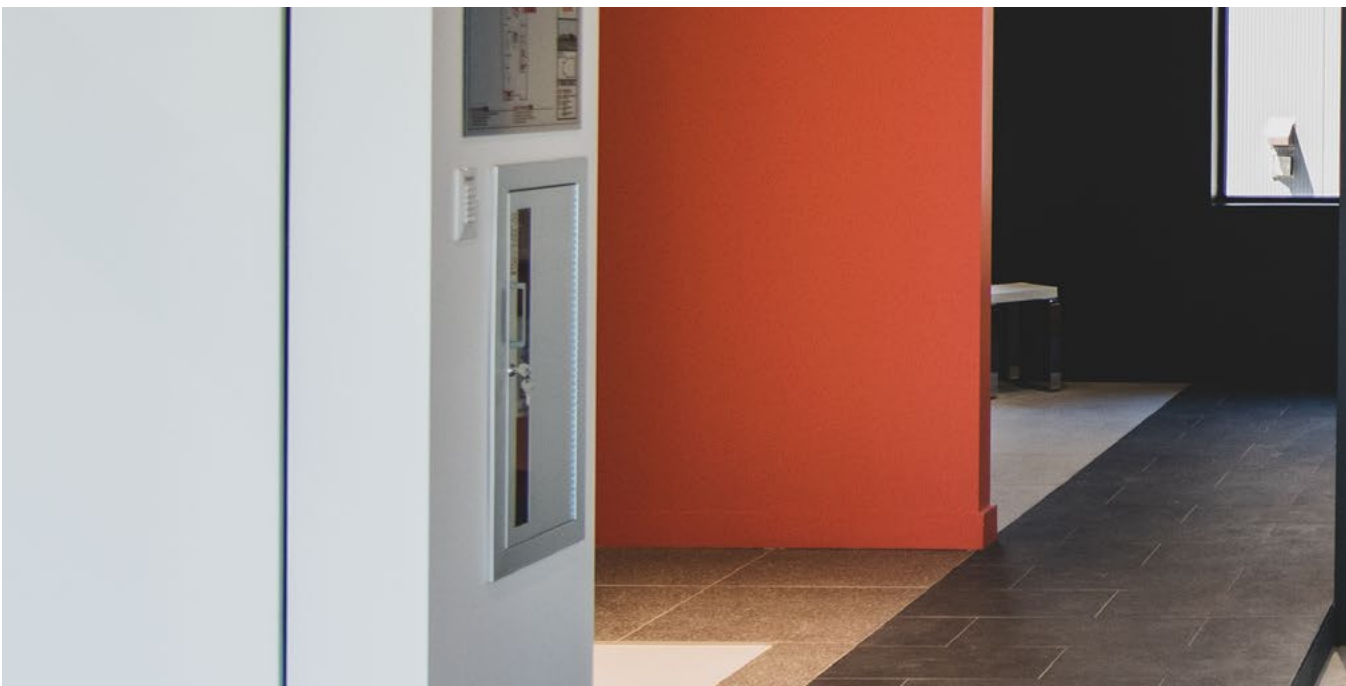



# 8500 PROFILE - REGULAR LED ENGINE

8000 Series



## Cross-section dimensions:

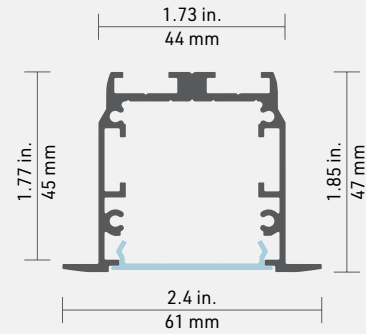

The ultimate in simplified LED lighting! The 8500 recessed profile is designed for use with standard and HOS LED engines. With its elegant and discreet edges, the 8500 fits perfectly and requires no plastering. Its ingenious design includes Type B grooves that allow the use of flat and 45°/135° joiners, ideal for angled fittings. **It is a masterpiece in terms of ease of installation, luminous intensity and creative set-up.**

## FEATURES

- Alu finish (white and black available on special order).
- Custom length up to 16 feet (192 in. - 4.85 m).
- Choice of standard or high power (HOS) LED engines to be used with or without PVC reflector, depending on whether the LED strip will be installed in the centre (single row) or in two rows (side by side).
- 4 lenses to choose from: Prime, Optiflex, Opal and Concave (flex).
- 6 color temperatures (2400 K to 6200 K).
- Spring brackets simplify installation and securely hold the extrusion in the opening.

## OPTIONS



## LED ENGINE COMPATIBILITY







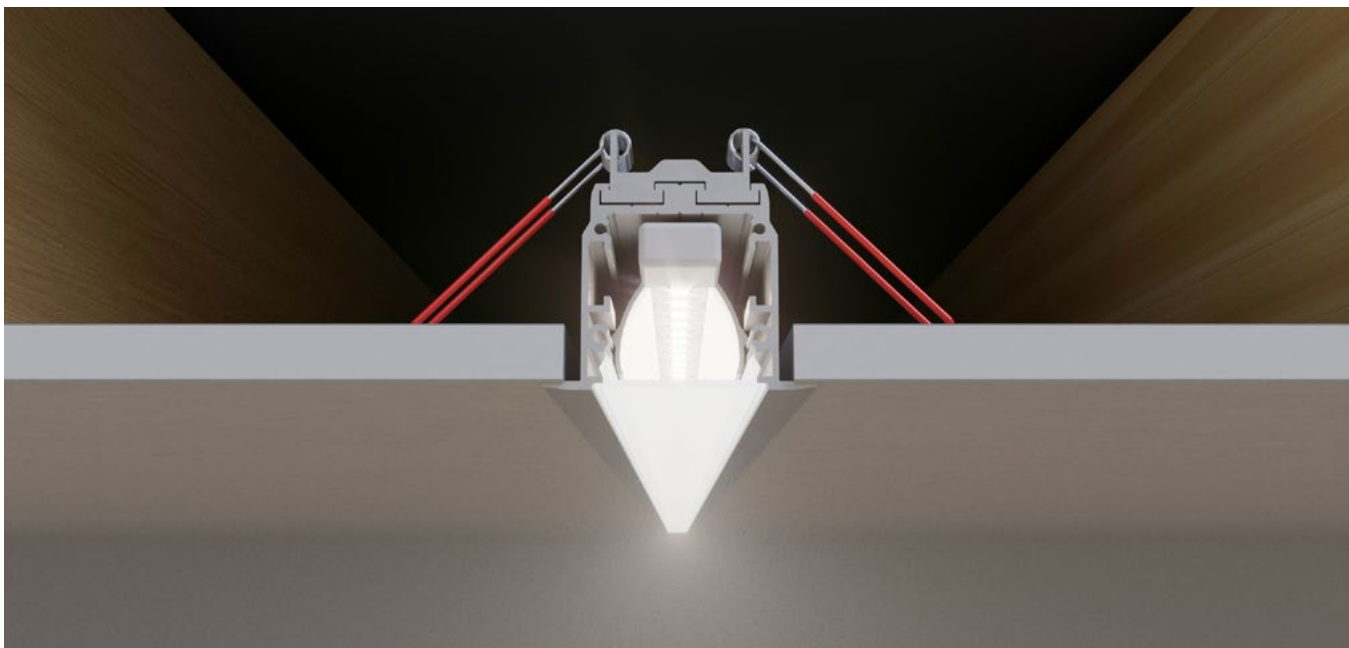

Compatible with LED engines up to **14mm** wide.

## LINEAR WEIGHT







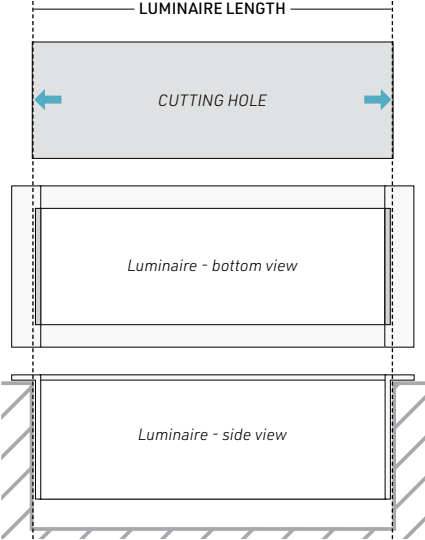









0.73 lbs/ft, 1.084 kg/m (without lens)





PROFILE	LENSES	MOUNTING HARDWARE	OPTION	LENGTH
 <p><b>8500</b> - Profile, Alu</p>	 <p><b>PR</b> - Prime flat lens</p>  <p><b>OX</b> - Optiflex flat lens</p>  <p><b>OP</b> - Opal flat lens</p>  <p><b>OXC</b> - Optiflex concave lens</p>  <p><b>BK</b> - Black lens</p> <p><b>NO</b> - No Lenses</p>	 <p><b>SP</b> - Spring bracket</p> <p><b>NO</b> - No mounting hardware</p>	 <p><b>HER</b> - High efficiency reflector</p> <p><b>NO</b> - No option</p>	<p>Custom length by sections of 2 to 192 inches (4.8m).</p> <p><b>*NOTE:</b> Follow this diagram to calculate the correct length</p> 
<b>8500</b>				
PROFILE	LENS	MOUNTING HARDWARE	OPTION	LENGTH

8000

COLOR TEMPERATURE	LUMEN PACKAGE**	LEAD IN/OUT	USAGE	POWER SUPPLY/CONTROL	*NOTES
<ul style="list-style-type: none"> <li> 24 - 2400K</li> <li> 27 - 2700K</li> <li> 30 - 3000K</li> <li> 35 - 3500K</li> <li> 42 - 4200K</li> <li> 53 - 5300K (LHP only)</li> <li> 62 - 6200K (LP only)</li> <li> <b>WD1</b> - WarmDim 14W</li> <li> <b>WD2</b> - WarmDim 17W</li> <li> <b>TW1</b> - Tunable White 11W</li> <li> <b>TW2</b> - Tunable White 19W</li> <li> <b>RGB1</b> - RGB 14W</li> <li> <b>RGB2</b> - RGB 19W</li> <li> <b>RGBW1</b> - 3000K</li> <li> <b>RGBW2</b> - 3000K 4in1</li> </ul>	<p><b>LP0</b> - 128 LM / 1.5W FT / 90+CRI</p> <p><b>LP1</b> - 160 LM / 1.5W FT / 90+CRI</p> <p><b>LP2</b> - 255 LM / 3.0W FT / 90+CRI</p> <p><b>LP3</b> - 308 LM / 4.5W FT / 90+CRI</p> <p><b>LP4</b> - 400 LM / 5.8W FT / 90+CRI</p> <p><b>LHP</b> - 700 LM / 7.0W FT / 95+CRI</p> <p><b>Note:</b> Not applicable for Warmdim Tunable White &amp; RGB color temperatures</p>	<p><b>HW3</b> - Hardwire 3 FT</p> <p><b>HW6</b> - Hardwire 6 FT</p> <p><b>HW9</b> - Hardwire 9 FT</p> <p><b>HWX</b> - Hardwire custom FT</p> <p><b>NO</b> - No lead</p>	<p><b>I</b> - IP22 indoor dry location</p>	<p><b>A</b> - Non-dimming</p> <p><b>B</b> - ELV dimming 120V AC</p> <p><b>C</b> - ELV dimming 120/277 VAC***</p> <p><b>D</b> - 0/10V dimming 120/277 VAC</p> <p><b>E</b> - Non-dimming DC plug in</p> <p><b>F</b> - DMX</p> <p><b>G</b> - Lutron - HI-LUME PREMIER 0,1% Eco System 24V/96W</p> <p><b>I</b> - Casambi CBU-A2D-0/10V-DALI-Bluetooth 100/277 VAC</p> <p><b>J</b> - Casambi CBU-PWM4-4CH-Bluetooth 100/277 VAC</p> <p><b>K</b> - Casambi CBU-TED-CV-Trail edge dim-Bluetooth 120 VAC</p> <p><b>NO</b> - No driver</p>	<p><b>* The light output is provided in lumens per foot, for a CCT of 4200K and a clear lens. Please refer to the optics page for CCT and translucency conversion factors.</b></p> <p><b>** By default both Up &amp; Down LED engines are controlled from one source. For custom options, please contact your local representative.</b></p> <p><b>***Only available in 96W - 24W Driver</b></p> 
SINGLE-STRIP 1    DOUBLE-STRIP 2*	SINGLE-STRIP 1    DOUBLE-STRIP 2*	LEAD IN    LEAD OUT	<b>I</b>	POWER SUPPLY/CONTROL	

# 8500 PROFILE - LUXLINE 120V

8000 Series

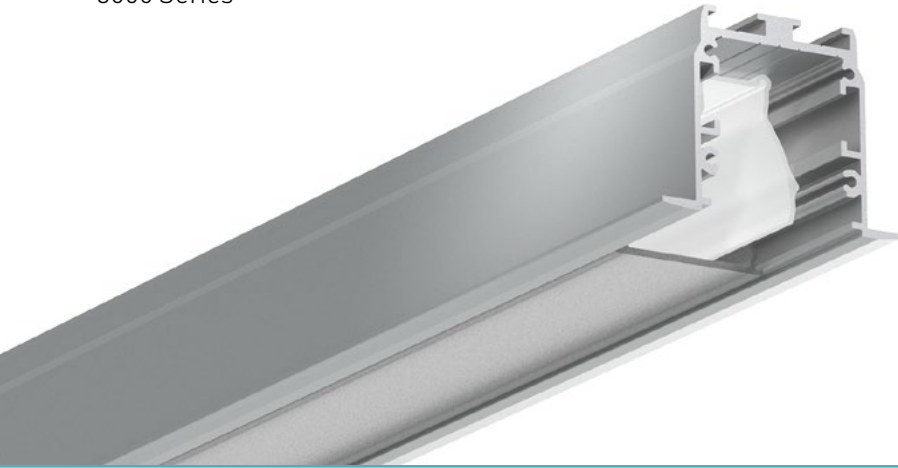

## Cross-section dimensions:

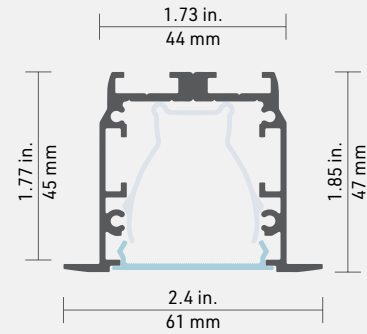

The ultimate in simplified LED lighting! The 8500 recessed profile is **designed for use with the LuxLine 120 V LED engine**. With its elegant and discreet edges, the 8500 fits perfectly and requires no plastering. Its ingenious design includes Type B grooves that allow the use of flat and 45°/135° joiners, ideal for angled fittings. It is a masterpiece in terms of ease of installation, connection and creative set-up.

## FEATURES

- Alu finish (white and black available on special order).
- Custom length up to 16 feet (192 in. - 4.85 m).
- No driver needed: 120V LuxLine light source, available up to 164 ft., for use with the PVC reflector that holds it in place and provides maximum luminance.
- 4 lenses to choose from: Prime, Optiflex, Opal and Concave (flex).
- 5 color temperatures (2400 K to 4000 K).
- Spring brackets simplify installation and securely hold the extrusion in the opening.
- Overmoulding options and DIY kit available.

## OPTIONS









## LED ENGINE COMPATIBILITY

Compatible with LED engines up to **14mm** wide.

## LINEAR WEIGHT

0.73 lbs/ft, 1.084 kg/m (without lens)

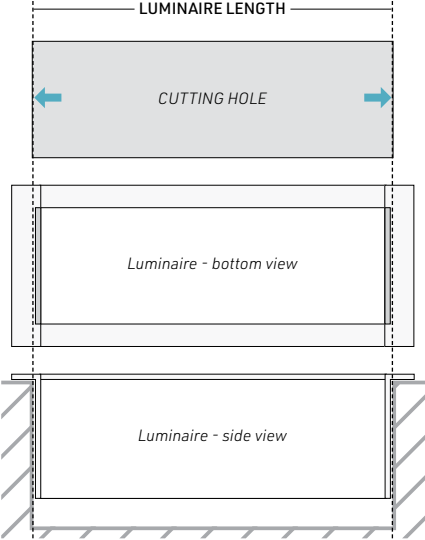

PROFILE	LENSES	MOUNTING HARDWARE	OPTION	LENGTH
 <p><b>8500</b> - Profile, Alu</p>	 <p><b>PR</b> - Prime flat lens</p>  <p><b>OP</b> - Opal flat lens</p>  <p><b>BK</b> - Black lens</p> <p><b>NO</b> - No Lenses</p>	 <p><b>SP</b> - Spring bracket</p> <p><b>NO</b> - No mounting hardware</p>	 <p><b>HER</b> - High efficiency reflector</p>	<p>Custom length by sections of 6 to 192 inches (4.8m).</p> <p><b>*NOTE:</b> Follow this diagram to calculate the correct length</p> 

<b>8500</b>			<b>HER</b>	
PROFILE	LENS	MOUNTING HARDWARE	OPTION	LENGTH

COLOR TEMPERATURE	LUMEN PACKAGE*	LEAD IN/OUT	JUMPER	USAGE	*NOTES
<ul style="list-style-type: none"> <li><span style="display: inline-block; width: 15px; height: 10px; background-color: #f4a460; border: 1px solid black; margin-right: 5px;"></span> 24 - 2400K</li> <li><span style="display: inline-block; width: 15px; height: 10px; background-color: #f08080; border: 1px solid black; margin-right: 5px;"></span> 27 - 2700K</li> <li><span style="display: inline-block; width: 15px; height: 10px; background-color: #f5deb3; border: 1px solid black; margin-right: 5px;"></span> 30 - 3000K</li> <li><span style="display: inline-block; width: 15px; height: 10px; background-color: #fff2cc; border: 1px solid black; margin-right: 5px;"></span> 35 - 3500K</li> <li><span style="display: inline-block; width: 15px; height: 10px; background-color: #fff2cc; border: 1px solid black; margin-right: 5px;"></span> 42 - 4000K</li> </ul>	<p><b>LUX</b> - 350 LM / 4.0W FT / 90+CRI</p>	<p><b>PG</b> - Plug-in 47"</p> <p><b>HW</b> - Hardwire 118"</p>	<p><b>JP6</b> - Jumper 6"</p> <p><b>JP12</b> - Jumper 12"</p> <p><b>NO</b> - No jumper</p>	<p><b>2</b> - IP65 indoor</p>	<p>The light output is provided in lumens per foot, for a CCT of 4200K and a clear lens. Please refer to the optics page for CCT and translucency conversion factors.</p> <div style="border: 1px solid gray; padding: 2px; width: fit-content; margin-top: 5px;"> <p><b>TITLE 24</b></p> <p>www.luxline.com</p> </div>
COLOR TEMPERATURE CCT	LUMEN PACKAGE	LEAD IN    LEAD OUT	JUMPER    QTY		

### LUXLINE FEATURES

- LumenTruss Driverless technology.
- Direct line voltage.
- Constant current IC providing uniform intensity over the entire run.
- Uses North American power plug with built-in fuse or hardwire.
- Order in lengths of 1 FT.
- 164 FT maximum run.
- Ultra high lumen output.
- Architectural grade.
- PVC coating (not recommended for direct sunlight).
- 3 year warranty.
- Life of 50,000 hours
- LED type: 3056
- WARNING: Do not cut AC plug.

### LUXLINE FEATURES

Plug-in Connection Diagram

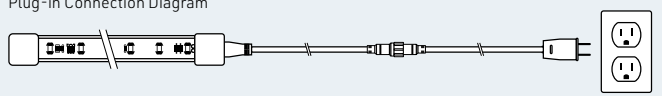

Hardwire Connection Diagram

**With the NEW revolutionary hardwire connection with built-in fuse! Exclusive to LumenTruss.**



# 8540 PRO - REGULAR PROFILE

8000 Series

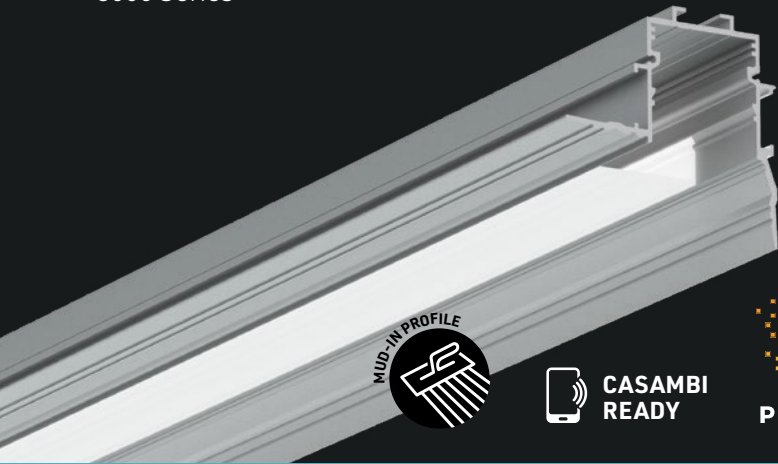

## Cross-section dimensions:

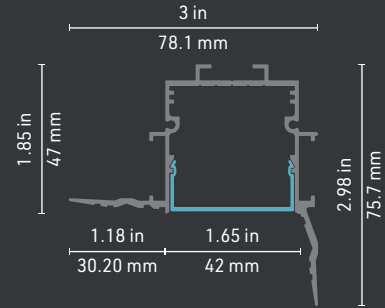

The 8540 Pro profile is designed to disappear into the structure, merging the light source with the surface. Its 90° edge on one side makes it ideal for contour lighting application. Very versatile with 15 LED light sources to choose from 2400 K to 6200 K including WarmDim, Tunable White, RGB and RGB white. Its refined look harmonizes perfectly with any project.

## FEATURES

- Available in 96 in (2.43 m) lengths including 3 straight Type C joiners; profile can be cut on-site for easy and accurate installation
- With a 90° edge on one side, ideal for corner walls and ceiling lighting
- On each side of the extrusion, the edges have grooves that reduce the space between the screws and the surface
- Designed to give a uniform light without hot spots with a prime lens.
- 15 LED light sources to choose from 2400 K to 6200 K, including WarmDim, Tunable White, RGB and RGBW
- Made of ALCOA 6063-T5 aluminum alloy for increased heat dissipation
- Compatible with the HER Pro PVC reflector that provides maximum luminance.
- Indoor use
- **Bonus:** PVC protector included with each profile

## OPTIONS



## LED ENGINE COMPATIBILITY

Compatible with LED engines up to **14mm** wide.

## LINEAR WEIGHT

Coming soon

8540 Pro with gypsum panels, just before applying drywall mud. Use our included cover/protector for mudding and painting.

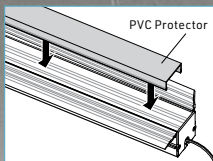



## EASY INSTALLATION

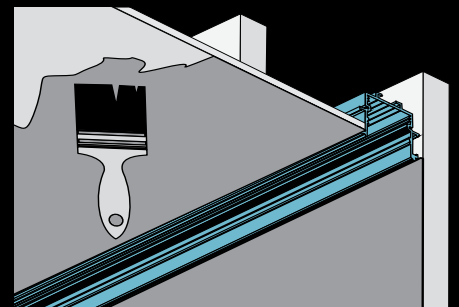
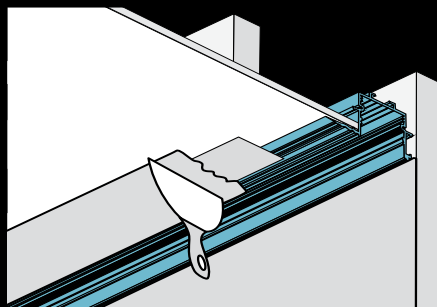
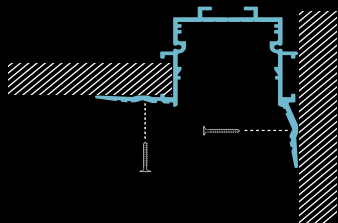

# CASAMBI

The Casambi lighting control solution provides all the control options that are expected from a full featured professional lighting control solution.



PART OF OUR  
**PRO SERIES**



## A BIG VARIETY OF POSSIBILITIES

The app for smartphones, tablets and smartwatches is the most elaborated user interface. Besides the app, traditional wall switches, push buttons, Casambi's own scene controllers and many other control points can be used. Available for ios and Android devices.



## CASAMBI FUNCTIONALITY



### LIGHT COLOUR

A user can change the colour in a simple manner from the app and also save his/her favorite colours in a colour palette.



### SUNRISE & SUNSET

Casambi units are able to calculate the the local sunrise and sunset times.



### CALENDAR & TIMER

With the calendar and timer, scenes and animations can be turned on and off based on a convenient time or date.



### COLOUR TEMPERATURE

Casambi offers a comprehensive colour temperature control. A user can change the CCT just by sliding the finger on top of an icon.



### GROUPING

After grouping, all the luminaires in the group can be controlled all together or the group can be opened for individual control.



### SCENES

Different lighting situations for different occasions can be created. It is possible to control multiple luminaires with one tap.













### DAYLIGHT SENSOR

The control solution allows dimming of artificial lighting when daylight is available for achieving maximum lighting quality.

















### OCCUPANCY SENSOR

The Casambi lighting control system supports movement sensors, also overlapping movement sensor information

PROFILE	LENGTH	LENSES	PVC PROTECTOR		
 <p>8540- Profile</p>	<p>Available in straight section of 8 feet (96 inches/2.4 m).</p>	 <p>PR - prime lens</p>	 <p>PVC - Pvc protector</p>		
<p>QUANTITY</p>	<p>X <b>96 INCHES</b></p> <p>LENGTH</p>	<p><b>INCLUDED</b></p> <p>WITH EACH PROFILE</p>	<p><b>INCLUDED</b></p> <p>WITH EACH PROFILE</p>		
ENCAPS	JOINERS				
 <p>8540 Endcaps</p>	 <p>JS - Type C straight joiner</p>	 <p>JH45 - Type C horiz. 45° joiner</p>	 <p>JH90 - Type C horiz. 90° joiner</p>	 <p>JV90 - Type C vert. 90° joiner</p>	 <p>JV45 - Type C vert. 45° joiner</p>
<p>ENDCAPS QUANTITY</p>	<p>QUANTITY</p>	<p>QUANTITY</p>	<p>QUANTITY</p>	<p>QUANTITY</p>	<p>QUANTITY</p>
ACCESSORIES					
 <p>Drywall small head screw (x100)</p>	 <p>HER PRO - High efficiency reflector v 2.0</p>				
<p>QUANTITY</p>	<p>QUANTITY</p>				

8000

LED engine will be assembled on site. See Appendix 3 on page 159 to see how to calculate total ordering length.

COLOR TEMPERATURE	LUMEN PACKAGE	LEAD IN	USAGE	POWER SUPPLY/CONTROL	LENGTH
<ul style="list-style-type: none"> <li> 24 - 2400K</li> <li> 27 - 2700K</li> <li> 30 - 3000K</li> <li> 35 - 3500K</li> <li> 42 - 4200K</li> <li> 53 - 5300K (LHP only)</li> <li> 62 - 6200K (LP only)</li> <li> WD1 - WarmDim 14W</li> <li> WD2 - WarmDim 17W</li> <li> TW1 - Tunable White 11W</li> <li> TW2 - Tunable White 19W</li> <li> RGB1 - RGB 14W</li> <li> RGB2 - RGB 19W</li> <li> RGBW1 - 3000K</li> <li> RGBW2 - 3000K 4in1</li> </ul>	<p>LP0 - 128 LM / 1.5W FT / 90+CRI</p> <p>LP1 - 160 LM / 1.5W FT / 90+CRI</p> <p>LP2 - 255 LM / 3.0W FT / 90+CRI</p> <p>LP3 - 308 LM / 4.5W FT / 90+CRI</p> <p>LP4 - 400 LM / 5.8W FT / 90+CRI</p> <p>LHP - 700 LM / 7.0W FT / 95+CRI</p> <p><b>Note:</b> Not applicable for Warmdim Tunable White &amp; RGB color temperatures</p>	<p>HW3 - Hardwire 3 FT</p> <p>HW6 - Hardwire 6 FT</p> <p>HW9 - Hardwire 9 FT</p> <p>HWX - Hardwire custom FT</p> <p>NO - No lead</p>	<p>I - IP22 indoor dry location</p>	<p>A - Non-dimming</p> <p>B - ELV dimming 120V AC</p> <p>C - ELV dimming 120/277 VAC**</p> <p>D - 0/10V dimming 120/277 VAC</p> <p>F - DMX</p> <p>G - Lutron - HI-LUME PREMIER 0,1% Eco System 24V/96W</p> <p>I - Casambi CBU-A2D-0/10V-DALI-Bluetooth 100/277 VAC</p> <p>J - Casambi CBU-PWM4-4CH-Bluetooth 100/277 VAC</p> <p>K - Casambi CBU-TED-CV-Trail edge dim-Bluetooth 120 VAC</p> <p>NO - No driver</p>	<p><b>Total length of LED engine in inches</b> - See Appendix 3 on how to calculate length.</p>
<p>COLOR TEMPERATURE CCT</p>	<p>LUMEN PACKAGE</p>	<p>LEAD IN</p>	<p>USAGE</p>	<p>POWER SUPPLY/CONTROL</p>	<p>LED ENGINE LENGTH</p>

\*NOTE: The light output is provided in lumens per foot, for a CCT of 4200K and a clear lens. Please refer to the optics page for CCT and translucency conversion factors. \*\* Only available in 96W - 24V Driver

TITLE 24

# 8540 PRO - LUXLINE 120V

8000 Series



## Cross-section dimensions:

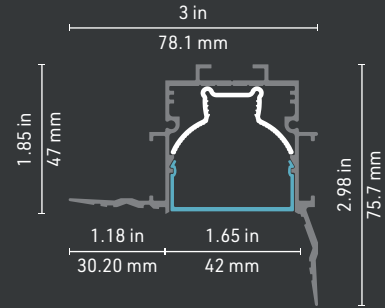

The 8540 Pro profile is designed to disappear into the structure, merging the light source with the surface and house our Luxline serie of 120V LED engine tape. Its 90° edge on one side makes it ideal for contour lighting application. Its refined look harmonizes perfectly with any project.

## FEATURES

- Available in 96 in (2.43 m) lengths including 3 straight Type C joiners; profile can be cut on-site for easy and accurate installation
- On each side of the extrusion, the edges have grooves that reduce the space between the screws and the surface
- No driver needed: 120V LuxLine light source, available up to 164 ft., for use with the HER Pro PVC reflector that holds it in place and provides maximum luminance.
- LuxLine lumen output: 350 lm / 4.0W ft / 90+ CRI
- 5 color temperatures (2400 K to 4000 K).
- Designed to give a uniform light without hot spots with a prime lens.
- Made of ALCOA 6063-T5 aluminum alloy for increased heat dissipation
- Indoor use
- **Bonus:** PVC protector included with each profile

## OPTIONS



## LED ENGINE COMPATIBILITY

Compatible with our LuxLine series of 120V LED engine tape.

## LINEAR WEIGHT

Coming soon









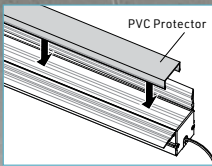

8540 Pro with gypsum panels, just before applying drywall mud. Use our included cover/protector for mudding and painting.

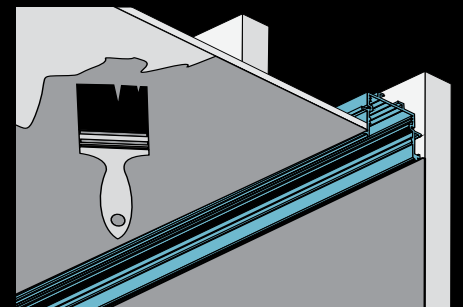
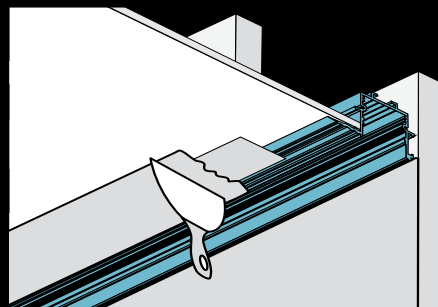
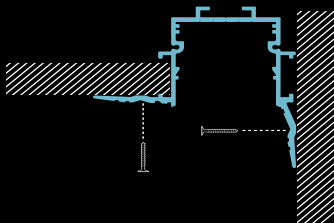







### EASY INSTALLATION





PROFILE	LENGTH	LENSES	PVC PROTECTOR	OPTION
 <p>8540 - Profile</p>	<p>Available in straight section of 8 feet (96 inches/2.4 m).</p>	 <p>PR - prime lens</p>	 <p>PVC - Pvc protector</p>	 <p>HER PRO - High efficiency reflector v.2.0</p>
	<p>X <b>96 INCHES</b></p>	<p><b>INCLUDED</b></p>	<p><b>INCLUDED</b></p>	<p><b>INCLUDED</b></p>
QUANTITY	LENGTH	WITH EACH PROFILE	WITH EACH PROFILE	WITH EACH PROFILE







  

ENCAPS	JOINERS				
 <p>8540 Endcaps</p>	 <p>JS - Type C straight joiner</p>	 <p>JH45 - Type C horiz. 45° joiner</p>	 <p>JH90 - Type C horiz. 90° joiner</p>	 <p>JV90 - Type C vert. 90° joiner</p>	 <p>JV45 - Type C vert. 45° joiner</p>
ENDCAPS QUANTITY	QUANTITY	QUANTITY	QUANTITY	QUANTITY	QUANTITY

  

ACCESSORIES
 <p>Drywall small head screw (x100)</p>
QUANTITY

8000

COLOR TEMPERATURE	LUMEN PACKAGE*	LEAD IN	USAGE	LENGTH	*NOTES
 24 - 2400K  27 - 2700K  30 - 3000K  35 - 3500K  42 - 4000K	LUX - 350 LM / 4.0W FT / 90+CRI	HW - Hardwire 118"	2 - IP65 indoor	<b>Total length of LED engine in inches</b> - See Appendix 3 on how to calculate length.	*The light output is provided in lumens per foot, for a CCT of 4200K and a clear lens. Please refer to the optics page for CCT and translucency conversion factors.
COLOR TEMPERATURE CCT	LUX	HW	IP65	LED ENGINE LENGTH	

- ### LUXLINE FEATURES
- LumenTruss Driverless technology.
  - Direct line voltage.
  - Constant current IC providing uniform intensity over the entire run.
  - Uses North American power plug with built-in fuse or hardwire.
  - Order in lengths of 1 FT.
  - 164 FT maximum run.
  - Ultra high lumen output.
  - Architectural grade.
  - PVC coating (not recommended for direct sunlight).
  - 3 year warranty.
  - Life of 50,000 hours
  - LED type: 3056
  - WARNING: Do not cut AC plug.

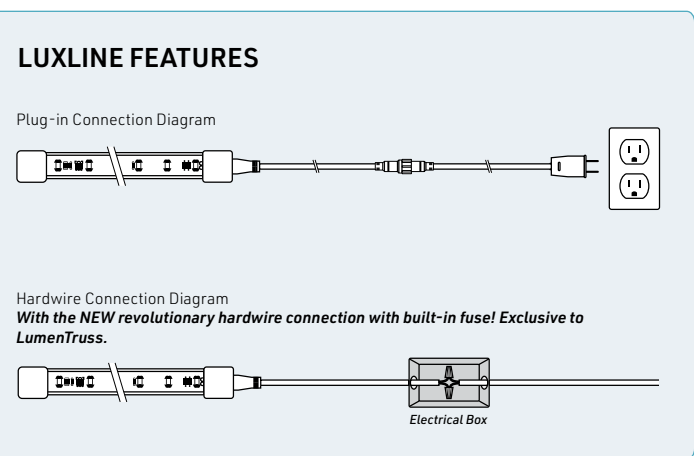

# 8550 PRO - REGULAR PROFILE

8000 Series



## Cross-section dimensions:

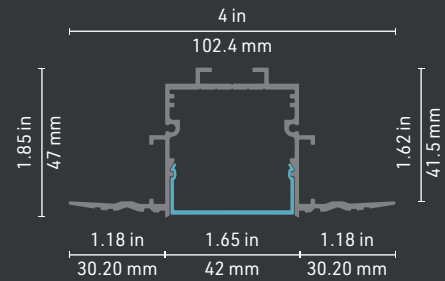

The 8550 Pro profile is designed to disappear into the structure, merging the light source with the surface. Very versatile with 15 LED light sources to choose from 2400 K to 6200 K including WarmDim, Tunable White, RGB and RGB white. Its refined look harmonizes perfectly with any project.

## FEATURES

- Available in 96 in (2.43 m) lengths including 3 straight Type C joiners; profile can be cut on-site for easy and accurate installation
- On each side of the extrusion, the edges have grooves that reduce the space between the screws and the surface
- Designed to give a uniform light without hot spots with a prime lens.
- 15 LED light sources to choose from 2400 K to 6200 K, including WarmDim, RGB and RGBW
- Made of ALCOA 6063-T5 aluminum alloy for increased heat dissipation
- Compatible with the HER Pro PVC reflector that provides maximum luminance.
- Indoor use
- **Bonus:** PVC protector included with each profile

## OPTIONS



## LED ENGINE COMPATIBILITY

Compatible with LED engines up to **14mm** wide.

## LINEAR WEIGHT

Coming soon





## EASY INSTALLATION

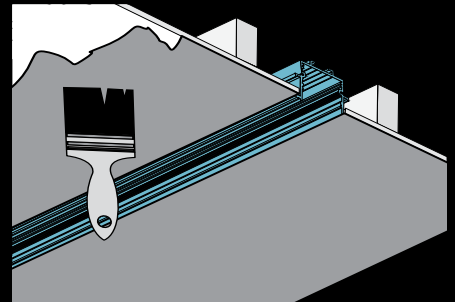
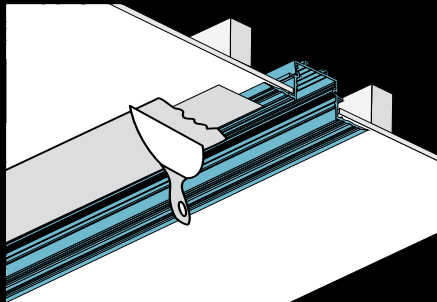
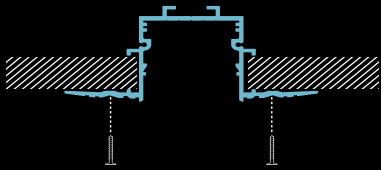

# CASAMBI

The Casambi lighting control solution provides all the control options that are expected from a full featured professional lighting control solution.



PART OF OUR  
**PRO SERIES**



## A BIG VARIETY OF POSSIBILITIES

The app for smartphones, tablets and smartwatches is the most elaborated user interface. Besides the app, traditional wall switches, push buttons, Casambi's own scene controllers and many other control points can be used. Available for ios and Android devices.



## CASAMBI FUNCTIONALITY



### LIGHT COLOUR

A user can change the colour in a simple manner from the app and also save his/her favorite colours in a colour palette.



### SUNRISE & SUNSET

Casambi units are able to calculate the the local sunrise and sunset times.



### CALENDAR & TIMER

With the calendar and timer, scenes and animations can be turned on and off based on a convenient time or date.



### COLOUR TEMPERATURE

Casambi offers a comprehensive colour temperature control. A user can change the CCT just by sliding the finger on top of an icon.



### GROUPING

After grouping, all the luminaires in the group can be controlled all together or the group can be opened for individual control.



### SCENES

Different lighting situations for different occasions can be created. It is possible to control multiple luminaires with one tap.





### DAYLIGHT SENSOR

The control solution allows dimming of artificial lighting when daylight is available for achieving maximum lighting quality.









### OCCUPANCY SENSOR



The Casambi lighting control system supports movement sensors, also overlapping movement sensor information

PROFILE	LENGTH	LENSES	PVC PROTECTOR
 8550 - Profile	Available in straight section of 8 feet (96 inches/2.4 m).	 PR - prime lens	 PVC - Pvc protector
	x <b>96 INCHES</b>	<b>INCLUDED</b>	<b>INCLUDED</b>
QUANTITY	LENGTH	WITH EACH PROFILE	WITH EACH PROFILE















  

ENCAPS	JOINERS				
 8550 Endcaps	 JS - Type C straight joiner	 JH45 - Type C horiz. 45° joiner	 JH90 - Type C horiz. 90° joiner	 JV90 - Type C vert. 90° joiner	 JV45 - Type C vert. 45° joiner
ENDCAPS QUANTITY	QUANTITY	QUANTITY	QUANTITY	QUANTITY	QUANTITY

ACCESSORIES	
 Drywall small head screw (x100)	 HER PRO - High efficiency reflector v 2.0
QUANTITY	QUANTITY

**LED engine will be assembled on site. See Appendix 3 on page 159 to see how to calculate total ordering length.**

COLOR TEMPERATURE	LUMEN PACKAGE	LEAD IN	USAGE	POWER SUPPLY/CONTROL	LENGTH
<ul style="list-style-type: none"> <li> 24 - 2400K</li> <li> 27 - 2700K</li> <li> 30 - 3000K</li> <li> 35 - 3500K</li> <li> 42 - 4200K</li> <li> 53 - 5300K (LHP only)</li> <li> 62 - 6200K (LP only)</li> <li> WD1 - WarmDim 14W</li> <li> WD2 - WarmDim 17W</li> <li> TW1 - Tunable White 11W</li> <li> TW2 - Tunable White 19W</li> <li> RGB1 - RGB 14W</li> <li> RGB2 - RGB 19W</li> <li> RGBW1 - 3000K</li> <li> RGBW2 - 3000K 4in1</li> </ul>	<ul style="list-style-type: none"> <li>LP0 - 128 LM / 1.5W FT / 90+CRI</li> <li>LP1 - 160 LM / 1.5W FT / 90+CRI</li> <li>LP2 - 255 LM / 3.0W FT / 90+CRI</li> <li>LP3 - 308 LM / 4.5W FT / 90+CRI</li> <li>LP4 - 400 LM / 5.8W FT / 90+CRI</li> <li>LHP - 700 LM / 7.0W FT / 95+CRI</li> </ul> <p><b>Note:</b> Not applicable for Warmdim Tunable White &amp; RGB color temperatures</p>	<ul style="list-style-type: none"> <li>HW3 - Hardwire 3 FT</li> <li>HW6 - Hardwire 6 FT</li> <li>HW9 - Hardwire 9 FT</li> <li>HWX - Hardwire custom FT</li> <li>NO - No lead</li> </ul>	<ul style="list-style-type: none"> <li>I - IP22 indoor dry location</li> </ul>	<ul style="list-style-type: none"> <li>A - Non-dimming</li> <li>B - ELV dimming 120V AC</li> <li>C - ELV dimming 120/277 VAC**</li> <li>D - 0/10V dimming 120/277 VAC</li> <li>F - DMX</li> <li>G - Lutron - HI-LUME PREMIER 0,1% Eco System 24V/96W</li> <li>I - Casambi CBU-A2D-0/10V-DALI-Bluetooth 100/277 VAC</li> <li>J - Casambi CBU-PWM4-4CH-Bluetooth 100/277 VAC</li> <li>K - Casambi CBU-TED-CV-Trail edge dim-Bluetooth 120 VAC</li> <li>NO - No driver</li> </ul>	<p><b>Total length of LED engine in inches</b> - See Appendix 3 on how to calculate length.</p>
COLOR TEMPERATURE CCT	LUMEN PACKAGE	LEAD IN	USAGE	POWER SUPPLY/CONTROL	LED ENGINE LENGTH

\*NOTE: The light output is provided in lumens per foot, for a CCT of 4200K and a clear lens. Please refer to the optics page for CCT and translucency conversion factors. \*\* Only available in 96W - 24V Driver

# 8550 PRO - LUXLINE 120V

8000 Series



## Cross-section dimensions:

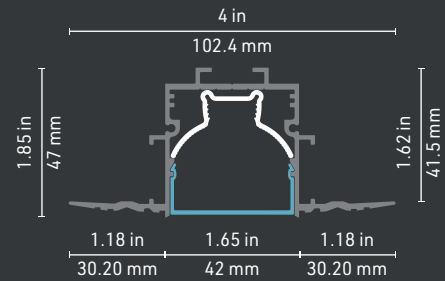

The 8550 Pro profile is designed to disappear into the structure, merging the light source with the surface and house our Luxline serie of 120V LED engine tape. Its refine look will harmonizes perfectly with any project.

## FEATURES

- Available in 96 in (2.43 m) lengths including 3 straight Type C joiners; profile can be cut on-site for easy and accurate installation
- On each side of the extrusion, the edges have grooves that reduce the space between the screws and the surface
- No driver needed: 120V LuxLine light source, available up to 164 ft., for use with the HER Pro PVC reflector that holds it in place and provides maximum luminance.
- LuxLine lumen output: 350 lm / 4.0W ft / 90+ CRI
- 5 color temperatures (2400 K to 4000 K).
- Designed to give a uniform light without hot spots with a prime lens.
- Made of ALCOA 6063-T5 aluminum alloy for increased heat dissipation
- Indoor use
- **Bonus:** PVC protector included with each profile

## OPTIONS



## LED ENGINE COMPATIBILITY

Compatible with our LuxLine series of 120V LED engine tape.

## LINEAR WEIGHT

Coming soon









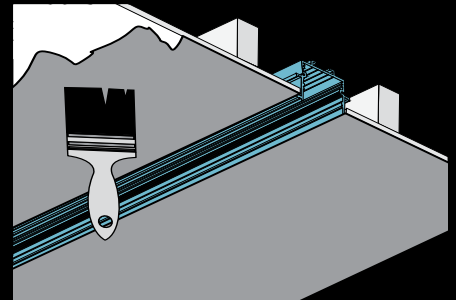
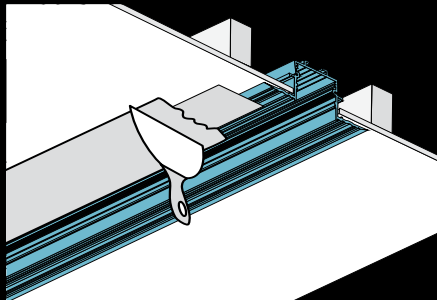
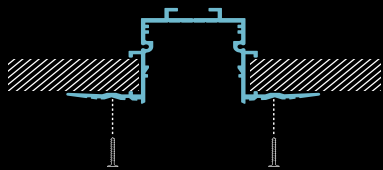













## EASY INSTALLATION





PROFILE	LENGTH	LENSES	PVC PROTECTOR	OPTION	
 <p>8540 - Profile</p>	<p>Available in straight section of 8 feet (96 inches/2.4 m).</p>	 <p>PR - prime lens</p>	 <p>PVC - Pvc protector</p>	 <p>HER PRO - High efficiency reflector v.2.0</p>	
	<p>X <b>96 INCHES</b></p>	<p><b>INCLUDED</b></p>	<p><b>INCLUDED</b></p>	<p><b>INCLUDED</b></p>	
QUANTITY	LENGTH	WITH EACH PROFILE	WITH EACH PROFILE	WITH EACH PROFILE	
ENCAPS	JOINERS				
 <p>8550 Endcaps</p>	 <p>JS - Type C straight joiner</p>	 <p>JH45 - Type C horiz. 45° joiner</p>	 <p>JH90 - Type C horiz. 90° joiner</p>	 <p>JV90 - Type C vert. 90° joiner</p>	 <p>JV45 - Type C vert. 45° joiner</p>
ENDCAPS QUANTITY	QUANTITY	QUANTITY	QUANTITY	QUANTITY	QUANTITY
ACCESSORIES					
 <p>Drywall small head screw (x100)</p>					
QUANTITY					

COLOR TEMPERATURE	LUMEN PACKAGE*	LEAD IN	USAGE	LENGTH	*NOTES
 24 - 2400K  27 - 2700K  30 - 3000K  35 - 3500K  42 - 4000K	LUX - 350 LM / 4.0W FT / 90+CRI	HW - Hardwire 118"	2 - IP65 indoor	<b>Total length of LED engine in inches</b> - See Appendix 3 on how to calculate length.	*The light output is provided in lumens per foot, for a CCT of 4200K and a clear lens. Please refer to the optics page for CCT and translucency conversion factors.
	<b>LUX</b>	<b>HW</b>	<b>IP65</b>		
COLOR TEMPERATURE CCT	LUMEN PACKAGE	LEAD IN	USAGE	LED ENGINE LENGTH	

- ### LUXLINE FEATURES
- LumenTruss Driverless technology.
  - Direct line voltage.
  - Constant current IC providing uniform intensity over the entire run.
  - Uses North American power plug with built-in fuse or hardwire.
  - Order in lengths of 1 FT.
  - 164 FT maximum run.
  - Ultra high lumen output.
  - Architectural grade.
  - PVC coating (not recommended for direct sunlight).
  - 3 year warranty.
  - Life of 50,000 hours
  - LED type: 3056
  - WARNING: Do not cut AC plug.

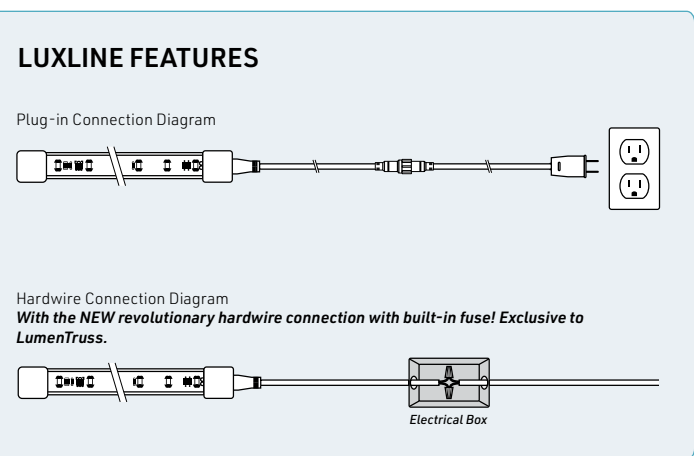

# 8800 PROFILE

8000 Series



## Cross-section dimensions:

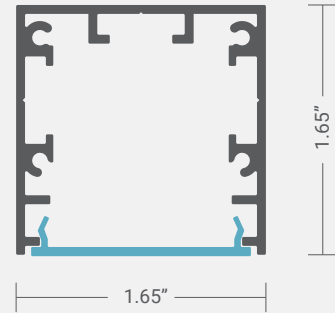

This new profile design will offer you a wide choice of optics, thanks to the development of various lens that will allow you to customize the light projection angle. In addition, its unique hardware will allow you to adjust the direction of your fixture to your needs, even after installation is complete.

## FEATURES

- Hardware specially developed to allow you to rotate the luminaire and guide the light source according to the circumstances.
- Can be used with a concave diffuser designed to hide the light source while maintaining the profile to the foreground.
- The combination of various lenses will offer a lighting distribution customized to your needs.
- Straight and clean lines will give a modern look to your decor.
- Optics available: Prime, Optiflex & concave diffuser.
- Designed to meet North American woodworking standards.

## OPTIONS























## LED ENGINE COMPATIBILITY















Compatible with LED engines and PCBs up to **33mm** wide.

## WEIGHT

0.563 lbs/ft, 0.8378 kg/m, without lenses.



PROFILE	LENSES	MOUNTING HARDWARE	CANOPY	OPTION	LENGTH
 <p><b>8800</b> - Profile, Alu</p>	 <p><b>PR</b> - Prime flat lens</p>	 <p><b>SW</b> - Swivel bracket kit</p>	<p><b>NOTE:</b> Only available with <b>SUS</b> bracket (suspension)</p>  <p><b>Remote driver canopy plate</b> See Appendix 2 on page 158 <b>CR0</b> - Alu <b>CR1</b> - Black <b>CR2</b> - White</p>	 <p><b>HER</b> - High efficiency reflector</p>	<p>Custom length by sections of 2 to 240"</p> <p>Maximum length using Loop Swivel Brackets = 96"</p>
 <p><b>8801</b> - Profile, Black</p>	 <p><b>OX</b> - Optiflex flat lens</p>	 <p>Type B dbl. chann. susp. kit with 15ft. aircraft cable <b>SUS</b> - 8800 suspension kit</p>	 <p><b>Integrated driver in canopy</b> See Appendix 2 on page 158 <b>CI0</b> - Alu <b>CI1</b> - Black <b>CI2</b> - White</p>	 <p><b>NO</b> - No option</p>	
 <p><b>8802</b> - Profile, White</p>	 <p><b>OP</b> - Opal flat lens</p>	 <p>Loop swivel bracket <b>SWRD</b> - Red <b>SWPK</b> - Pink <b>SWCY</b> - Cyan <b>SWBK</b> - Black <b>SWBL</b> - Blue <b>SWWH</b> - White <b>SWGR</b> - Green <b>SWTR</b> - Transparent <b>SWOR</b> - Orange</p>	 <p><b>Integrated driver &amp; suspension kit</b> See Appendix 2 on page 158 <b>CIK0</b> - Alu <b>CIK1</b> - Black <b>CIK2</b> - White</p>		
 <p><b>880X</b> - Profile, Custom color</p> <p><b>IMPORTANT:</b> Give RAL color No See Appendix 1 on page 158</p>	 <p><b>OXC</b> - Optiflex concave lens</p>	 <p><b>NO</b> - No mounting hardware</p>	 <p><b>NO</b> - No canopy</p>		
 <p><b>BK</b> - Black lens</p>	 <p><b>NO</b> - No Lenses</p>				
RAL NUMBER					
PROFILE	LENS	MOUNTING HARDWARE	CANOPY	OPTION	LENGTH

COLOR TEMPERATURE	LUMEN PACKAGE**	LEAD IN/OUT	USAGE	POWER SUPPLY/CONTROL	*NOTES
<p> <b>24</b> - 2400K</p> <p> <b>27</b> - 2700K</p> <p> <b>30</b> - 3000K</p> <p> <b>35</b> - 3500K</p> <p> <b>42</b> - 4200K</p> <p> <b>53</b> - 5300K (LHP only)</p> <p> <b>62</b> - 6200K (LP only)</p> <p> <b>WD1</b> - WarmDim 14W</p> <p> <b>WD2</b> - WarmDim 17W</p> <p> <b>TW1</b> - Tunable White 11W</p> <p> <b>TW2</b> - Tunable White 19W</p> <p> <b>RGB1</b> - RGB 14W</p> <p> <b>RGB2</b> - RGB 19W</p> <p> <b>RGBW1</b> - 3000K</p> <p> <b>RGBW2</b> - 3000K 4in1</p>	<p><b>LP0</b> - 128 LM / 1.5W FT / 90+CRI</p> <p><b>LP1</b> - 160 LM / 1.5W FT / 90+CRI</p> <p><b>LP2</b> - 255 LM / 3.0W FT / 90+CRI</p> <p><b>LP3</b> - 308 LM / 4.5W FT / 90+CRI</p> <p><b>LP4</b> - 400 LM / 5.8W FT / 90+CRI</p> <p><b>LHP</b> - 700 LM / 7.0W FT / 95+CRI</p> <p><b>Note:</b> Not applicable for Warmdim Tunable White &amp; RGB color temperatures</p>	<p><b>HW3</b> - Hardwire 3 FT</p> <p><b>HW6</b> - Hardwire 6 FT</p> <p><b>HW9</b> - Hardwire 9 FT</p> <p><b>HWX</b> - Hardwire custom FT</p> <p><b>DC3</b> - DC plug 3 FT</p> <p><b>DC6</b> - DC plug 6 FT</p> <p><b>DC9</b> - DC plug 9 FT</p> <p><b>DCX</b> - DC plug custom FT</p> <p><b>SUS</b> - Coaxial wire 15 FT</p> <p><b>NO</b> - No lead</p>	<p><b>1</b> - IP22 indoor dry location</p> <p><b>0</b> - IP68 wet/damp location</p>	<p><b>A</b> - Non-dimming</p> <p><b>B</b> - ELV dimming 120V AC</p> <p><b>C</b> - ELV dimming 120/277 VAC***</p> <p><b>D</b> - 0/10V dimming 120/277 VAC</p> <p><b>E</b> - Non-dimming DC plug in</p> <p><b>F</b> - DMX</p> <p><b>G</b> - Lutron - HI-LUME PREMIER 0,1% Eco System 24V/96W</p> <p><b>I</b> - Casambi CBU-A2D-0/10V-DALI-Bluetooth 100/277 VAC</p> <p><b>J</b> - Casambi CBU-PWM4-4CH-Bluetooth 100/277 VAC</p> <p><b>K</b> - Casambi CBU-TED-CV-Trail edge dim-Bluetooth 120 VAC</p> <p><b>NO</b> - No driver</p>	<p>* Double strip option cannot be used with the reflector.</p> <p>**The light output is provided in lumens per foot, for a CCT of 4200K and a clear lens. Please refer to the optics page for CCT and translucency conversion factors.</p> <p>*** Only available in 96W - 24V Driver.</p>
SINGLE-STRIP 1 DOUBLE-STRIP 2*	SINGLE-STRIP 1 DOUBLE-STRIP 2*	LEAD IN LEAD OUT	USAGE	POWER SUPPLY/CONTROL	

# 8860 PROFILE

8000 Series



## Cross-section dimensions:

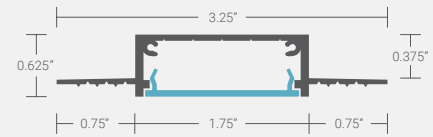

With a direct fit for standard 5/8" and 1/2" gypsum panels, the 8860 profile makes it easy to install recessed linear LED lights on ceilings or walls, in a few simple steps, creating a nice and smooth effect. Can be use with standard drywalls with no need to change the structure under the panels. The light source will seem to merge with the surface which creates a refine look that will work well with any design!

## FEATURES

- A direct fit for standard 5/8" and 1/2" gypsum panels.
- The grooves found on the flaps help reduce the gap between the screws and the surface.
- The LED channels allows the installation of two double strip tape (19.2w) side by side, for maximum lighting power.
- Available in precut sections of 96 inches (2.4 m).
- Made of ALCOA 6063-T5 aluminum alloy increasing heat dissipation.
- Designed to meet North American woodworking standards.

## OPTIONS



## LED ENGINE COMPATIBILITY

Compatible with LED engines up to **30mm** wide in total for direct light options and up to **5mm** wide on either side for edge light options.





## LINEAR WEIGHT

0.380 lbs/ft, 0.5656 kg/m, without lenses.



# 8860 Profile ordering sheet

# 8000 Series

PROFILE	LENGTH	LENSES	PVC PROTECTOR
 8860 - Profile	Available in straight section of 8 feet (96 inches/2.4 m).	 PR - prime lens	 PVC - Pvc protector
QUANTITY	<b>96 INCHES</b> LENGTH	<b>INCLUDED</b> WITH EACH PROFILE	<b>INCLUDED</b> WITH EACH PROFILE
ENCAPS			
 8860 Endcaps			
QUANTITY			

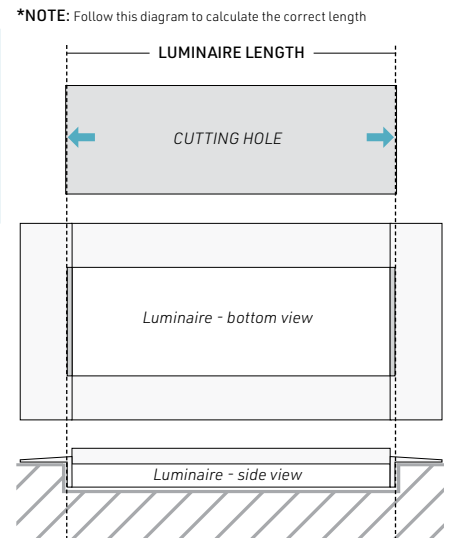

LED engine will be assembled on site. See Appendix 3 on page 159 to see how to calculate total ordering length.



## DIRECT LIGHTING OPTION (one or two LED engines)

COLOR TEMPERATURE	LUMEN PACKAGE*	LEAD IN / OUT	USAGE	POWER SUPPLY / CONTROL	LENGTH
24 - 2400K	LP0 - 128 LM / 1.5W FT / 90+CRI	HW3 - Hardwire 3 FT	I - IP22 indoor dry location	A - Non-dimming	Total length of LED engine in inches - See Appendix 3 on how to calculate length.
27 - 2700K	LP1 - 160 LM / 1.5W FT / 90+CRI	HW6 - Hardwire 6 FT		B - ELV dimming 120V AC	
30 - 3000K	LP2 - 255 LM / 3.0W FT / 90+CRI	HW9 - Hardwire 9 FT		C - ELV dimming 120/277 VAC**	
35 - 3500K	LP3 - 308 LM / 4.5W FT / 90+CRI	HWX - Hardwire custom FT		D - 0/10V dimming 120/277 VAC	
42 - 4200K	LHP - 700 LM / 7.0W FT / 95+CRI	NO - No lead		E - Non-dimming DC plug in	
53 - 5300K (LHP only)	<b>Note:</b> Not applicable for WarmDim Tunable White & RGB color temperatures			F - DMX	
62 - 6200K (LP only)				G - Lutron - HI-LUME PREMIER 0,1% Eco System 24V/96W	
WD1 - WarmDim 14W				I - Casambi CBU-A2D-0/10V-DALI-Bluetooth 100/277 VAC	
WD2 - WarmDim 17W				J - Casambi CBU-PWM4-4CH-Bluetooth 100/277 VAC	
TW1 - Tunable White 11W				K - Casambi CBU-TED-CV-Trail edge dim-Bluetooth 120 VAC	
TW2 - Tunable White 19W				NO - No driver	
RGB1 - RGB 14W					
RGB2 - RGB 19W					
RGBW1 - 3000K					
RGBW2 - 3000K 4in1					

SINGLE-STRIP 1 DOUBLE-STRIP 2 SINGLE-STRIP 1 DOUBLE-STRIP 2 LEAD IN LEAD OUT USAGE POWER SUPPLY / CONTROL LED ENGINE LENGTH



## DOT-FREE EDGE LIGHTING OPTION (two LED engines)

COLOR TEMPERATURE	LUMEN PACKAGE*	LEAD IN/OUT	USAGE	POWER SUPPLY/CONTROL	LENGTH
24 - 2400K	<b>2LP3</b>	HW3 - Hardwire 3 FT	I - IP22 indoor dry location	A - Non-dimming	Total length of LED engine in inches - See Appendix 3 on how to calculate length.
27 - 2700K		HW6 - Hardwire 6 FT		B - ELV dimming 120V AC	
30 - 3000K		HW9 - Hardwire 9 FT		C - ELV dimming 120/277 VAC**	
35 - 3500K		HWX - Hardwire custom FT		D - 0/10V dimming 120/277 VAC	
42 - 4200K		NO - No lead		E - Non-dimming DC plug in	
53 - 5300K				F - DMX	
			G - Lutron - HI-LUME PREMIER 0,1% Eco System 24V/96W		
			I - Casambi CBU-A2D-0/10V-DALI-Bluetooth 100/277 VAC		
			J - Casambi CBU-PWM4-4CH-Bluetooth 100/277 VAC		
			K - Casambi CBU-TED-CV-Trail edge dim-Bluetooth 120 VAC		
			NO - No driver		

COLOR TEMPERATURE CCT LUMEN PACKAGE LEAD IN LEAD OUT USAGE POWER SUPPLY/CONTROL LED ENGINE LENGTH

**\*NOTE:** The light output is provided in lumens per foot, for a CCT of 4200K and a clear lens. Please refer to the optics page for CCT and translucency conversion factors. \*\* Only available in 96W - 24V Driver

# 8870 PRO PROFILE

8000 Series



## Cross-section dimensions:

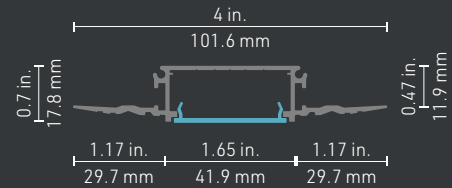

The 8870 Pro profile is designed to disappear into the structure so that the light source merges with the surface. The LED trays are perfectly smooth and allow the installation of two strip tapes (5.9 W/ft) side by side for maximum lighting power, or face to face for optimal light diffusion. A new feature: it can be used with all type B joiners to build a solid structure, and it fits directly with standard gypsum panels for an impeccable finish. Its refined look harmonizes perfectly with any design.

## FEATURES

- Available in 96 in (2.43 m) lengths including 2 straight Type B joiners; profile can be cut on-site for easy and accurate installation
- Fits directly over standard 5/8" gypsum panels; can also accept 1/2" panels with 1/8" shims installed on-site
- On each side of the extrusion, the edges have grooves that reduce the space between the screws and the surface
- LED trays designed for two light sources installed side-by-side (5.9 W/ft) for maximum light output or face-to-face for optimal light distribution
- 10 LED light sources to choose from 2400 K to 6200 K, including WarmDim, RGB and RGBW
- Application guide for light sources of 10 mm (0.394") or less in IP22
- Made of ALCOA 6063-T5 aluminum alloy for increased heat dissipation
- Indoor use
- **Bonus:** PVC protector included with each profile

## OPTIONS



## LED ENGINE COMPATIBILITY

Compatible with LED engines up to **30mm** wide in total for direct light options and up to **5mm** wide on either side for edge light options.

## LINEAR WEIGHT

0.380 lbs/ft, 0.5656 kg/m, without lenses.

















# 8870 PRO Profile ordering sheet















# 8000 Series

PROFILE	LENGTH	LENSES	PVC PROTECTOR
 8870 - Profile	Available in straight section of 8 feet (96 inches/2.4 m).	 PR - prime lens	 PVC - Pvc protector
QUANTITY	<b>96 INCHES</b> LENGTH	<b>INCLUDED</b> WITH EACH PROFILE	<b>INCLUDED</b> WITH EACH PROFILE
ENCAPS	JOINERS	ACCESSORIES	
 8860 Endcaps	 Type A straight joiner	 Type A horz. 45°/135° joiner	 Type A horz. 90° joiner
 Drywall small head screw (x100)			
ENDCAPS QUANTITY	QUANTITY	QUANTITY	QUANTITY

LED engine will be assembled on site. See Appendix 3 on page 159 to see how to calculate total ordering length.









## DIRECT LIGHTING OPTION (one or two LED engines)

COLOR TEMPERATURE	LUMEN PACKAGE*	LEAD IN / OUT	USAGE	POWER SUPPLY / CONTROL	LENGTH
<ul style="list-style-type: none"> <li> 24 - 2400K</li> <li> 27 - 2700K</li> <li> 30 - 3000K</li> <li> 35 - 3500K</li> <li> 42 - 4200K</li> <li> 53 - 5300K (LHP only)</li> <li> 62 - 6200K (LP only)</li> <li> WD1 - WarmDim 14W</li> <li> WD2 - WarmDim 17W</li> <li> TW1 - Tunable White 11W</li> <li> TW2 - Tunable White 19W</li> <li> RGB1 - RGB 14W</li> <li> RGB2 - RGB 19W</li> <li> RGBW1 - 3000K</li> <li> RGBW2 - 3000K 4in1</li> </ul>	<p>LP0 - 128 LM / 1.5W FT / 90+CRI</p> <p>LP1 - 160 LM / 1.5W FT / 90+CRI</p> <p>LP2 - 255 LM / 3.0W FT / 90+CRI</p> <p>LP3 - 308 LM / 4.5W FT / 90+CRI</p> <p>LHP - 700 LM / 7.0W FT / 95+CRI</p> <p><b>Note:</b> Not applicable for Warmdim Tunable White &amp; RGB color temperatures</p>	<p>HW3 - Hardwire 3 FT</p> <p>HW6 - Hardwire 6 FT</p> <p>HW9 - Hardwire 9 FT</p> <p>HWX - Hardwire custom FT</p> <p>NO - No lead</p>	I - IP22 indoor dry location	<p>A - Non-dimming</p> <p>B - ELV dimming 120V AC</p> <p>C - ELV dimming 120/277 VAC**</p> <p>D - 0/10V dimming 120/277 VAC</p> <p>E - Non-dimming DC plug in</p> <p>F - DMX</p> <p>G - Lutron - HI-LUME PREMIER 0,1% Eco System 24V/96W</p> <p>I - Casambi CBU-A2D-0/10V-DALI-Bluetooth 100/277 VAC</p> <p>J - Casambi CBU-PWM4-4CH-Bluetooth 100/277 VAC</p> <p>K - Casambi CBU-TED-CV-Trail edge dim-Bluetooth 120 VAC</p> <p>NO - No driver</p>	<b>Total length of LED engine in inches</b> - See Appendix 3 on how to calculate length.
SINGLE-STRIP 1    DOUBLE-STRIP 2	SINGLE-STRIP 1    DOUBLE-STRIP 2	LEAD IN    LEAD OUT	USAGE	POWER SUPPLY / CONTROL	LED ENGINE LENGTH



## DOT-FREE EDGE LIGHTING OPTION (two LED engines)

COLOR TEMPERATURE	LUMEN PACKAGE*	LEAD IN/OUT	USAGE	POWER SUPPLY/CONTROL	LENGTH
<ul style="list-style-type: none"> <li> 24 - 2400K</li> <li> 27 - 2700K</li> <li> 30 - 3000K</li> <li> 35 - 3500K</li> <li> 42 - 4200K</li> <li> 53 - 5300K</li> </ul>	<p>2LP3 - 308 LM / 4.5W FT / 90+CRI</p>	<p>HW3 - Hardwire 3 FT</p> <p>HW6 - Hardwire 6 FT</p> <p>HW9 - Hardwire 9 FT</p> <p>HWX - Hardwire custom FT</p> <p>NO - No lead</p>	I - IP22 indoor dry location	<p>A - Non-dimming</p> <p>B - ELV dimming 120V AC</p> <p>C - ELV dimming 120/277 VAC**</p> <p>D - 0/10V dimming 120/277 VAC</p> <p>E - Non-dimming DC plug in</p> <p>F - DMX</p> <p>G - Lutron - HI-LUME PREMIER 0,1% Eco System 24V/96W</p> <p>I - Casambi CBU-A2D-0/10V-DALI-Bluetooth 100/277 VAC</p> <p>J - Casambi CBU-PWM4-4CH-Bluetooth 100/277 VAC</p> <p>K - Casambi CBU-TED-CV-Trail edge dim-Bluetooth 120 VAC</p> <p>NO - No driver</p>	<b>Total length of LED engine in inches</b> - See Appendix 3 on how to calculate length.
COLOR TEMPERATURE CCT	<b>2LP3</b> LUMEN PACKAGE	LEAD IN    LEAD OUT	USAGE	POWER SUPPLY/CONTROL	LED ENGINE LENGTH

\*NOTE: The light output is provided in lumens per foot, for a CCT of 4200K and a clear lens. Please refer to the optics page for CCT and translucency conversion factors. \*\* Only available in 96W - 24V Driver

# 8900 PROFILE (KNIFE EDGE)

8000 Series

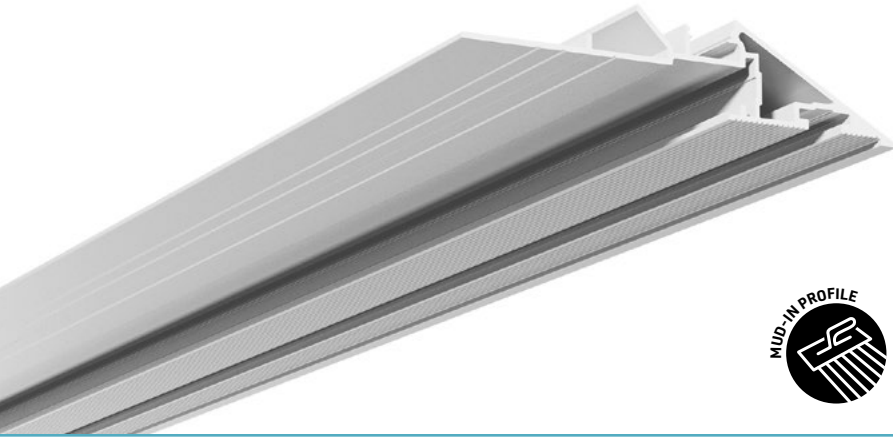

## Cross-section dimensions:

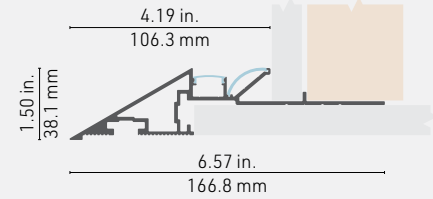

The 8900 "Knife Edge" profile makes the construction of **edgeless coves and drop ceiling soffits** a breeze. Its direct fit for standard gypsum panels allows for a seamless finish. Two integrated LED channels allow you to **add contour lighting, fill space with light, or both**. Build rectangular shapes using pre-built corners and straight line extrusions, tune the light with your choice of LED engines, paint to match, and you're done!

## FEATURES

- A direct fit for standard 5/8" gypsum panels, will also accommodate 1/2" panels with the installation of 1/8" shims onsite.
- The grooved area allows to level the profile to the plasterboard using drywall mud.
- Two different LED channels, a 90 degrees to focus the light in the cove, a 40 degrees to wash of the ceiling, use both for a maximum indirect lighting.
- The LED channels are designed for up to 14mm wide LED light engine. Are to be ordered to desired lengths for easier installation.
- Ordered in length of 96 inches (2.43m), cuttable on site for easy and precise installation.
- Available for easier installation, 2 types of pre-made corners, inside corner (8901) lighting on 90 degree, and outside corner (8902) lighting on 270 degree.
- Each 96" inch section and corners includes both series 1000 Standard (1261) and 2000 round Optiflex (2034) lenses and 2 type C straight joiners (see accessories for additional joiners).
- Made of ALCOA 6063-T5 aluminum alloy for increased heat dissipation.
- Designed to meet North American woodworking standards.

## OPTIONS



## LED ENGINE COMPATIBILITY

Both LED channels are compatible with LED engines up to **14mm** wide.



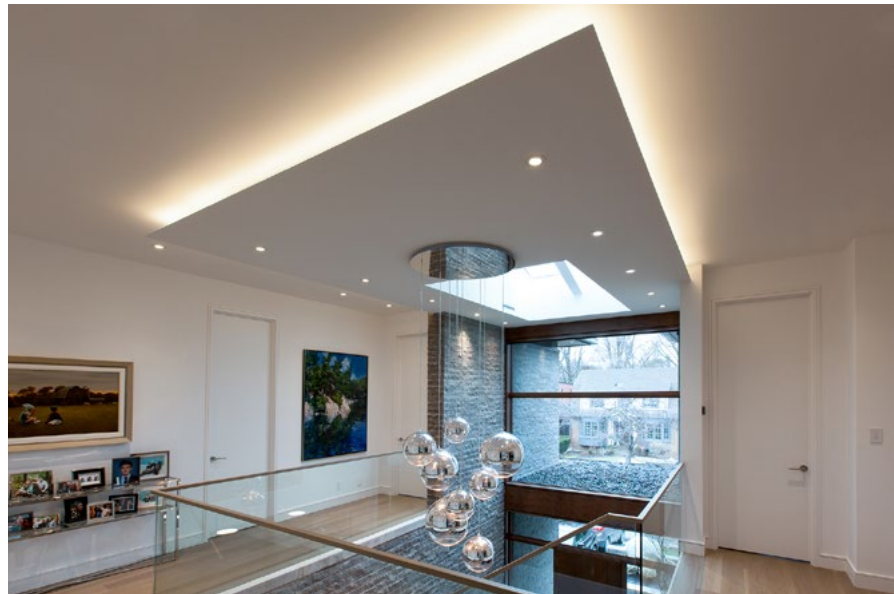
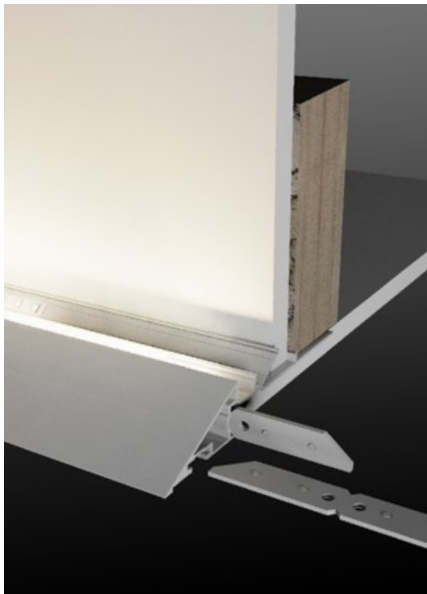

## LINEAR WEIGHT

1.288 lbs/ft, 1.916 kg/m, without lenses.

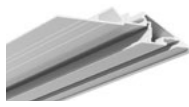

# 8900 Profile (KNIFE EDGE) ordering sheet





# 8000 Series

PROFILE	LENGTH	90° UP LENS	40° SIDE LENS	ACCESSORIES
 8900 - Profile	Available in straight section of 8 feet (96 inches/2.4 m).	 OX - Optiflex lens	 OXR - Optiflex lens, round	 JS - Type C straight joiner
KIT QUANTITY	X <b>96 INCHES</b> LENGTH	<b>INCLUDED</b> WITH EACH PROFILE	<b>INCLUDED</b> WITH EACH PROFILE	<b>INCLUDED X2</b> WITH EACH PROFILE

### EXTRA ACCESSORIES

 JS - Type C straight joiner	 JH45 - Type C horiz. 45° joiner	 JH90 - Type C horiz. 90° joiner	 JV90 - Type C vert. 90° joiner	 JV45 - Type C vert. 45° joiner
QUANTITY	QUANTITY	QUANTITY	QUANTITY	QUANTITY















### PRE-MADE CORNERS

 I90 - Inside corner 90°	 O270 - Outside corner 270°	 I45 - Inside corner 45°	 O45 - Outside corner 45°
QUANTITY	QUANTITY	QUANTITY	QUANTITY

### LENS + ACCESSORIES

<b>90° UP LENS</b> OX - Optiflex lens
<b>40° SIDE LENS</b> OXR - Optiflex lens, round
<b>ACCESSORIES</b> JS - Type C straight joiner
<b>INCLUDED</b> WITH EACH CORNER

LED engine will be assembled on site. See Appendix 3 on page 159 to see how to calculate total ordering length.

COLOR TEMPERATURE	LUMEN PACKAGE*	LEAD IN/OUT	USAGE	POWER SUPPLY/CONTROL	LENGTH
<ul style="list-style-type: none"> <li> 24 - 2400K</li> <li> 27 - 2700K</li> <li> 30 - 3000K</li> <li> 35 - 3500K</li> <li> 42 - 4200K</li> <li> 53 - 5300K (LHP only)</li> <li> 62 - 6200K (LP only)</li> <li> WD1 - WarmDim 14W</li> <li> WD2 - WarmDim 17W</li> <li> TW1 - Tunable White 11W</li> <li> TW2 - Tunable White 19W</li> <li> RGB1 - RGB 14W</li> <li> RGB2 - RGB 19W</li> <li> RGBW1 - 3000K</li> <li> RGBW2 - 3000K 4in1</li> </ul>	<p>LP0 - 128 LM / 1.5W FT / 90+CRI</p> <p>LP1 - 160 LM / 1.5W FT / 90+CRI</p> <p>LP2 - 255 LM / 3.0W FT / 90+CRI</p> <p>LP3 - 308 LM / 4.5W FT / 90+CRI</p> <p>LP4 - 400 LM / 5.8W FT / 90+CRI</p> <p>LHP - 700 LM / 7.0W FT / 95+CRI</p> <p><b>Note:</b> Not applicable for WarmDim Tunable White &amp; RGB color temperatures</p>	<p>HW3 - Hardwire 3 FT</p> <p>HW6 - Hardwire 6 FT</p> <p>HW9 - Hardwire 9 FT</p> <p>HWX - Hardwire custom FT</p> <p>NO - No lead</p>	I - IP22 indoor dry location	<p>A - Non-dimming</p> <p>B - ELV dimming 120V AC</p> <p>C - ELV dimming 120/277 VAC**</p> <p>D - 0/10V dimming 120/277 VAC</p> <p>E - Non-dimming DC plug in</p> <p>F - DMX</p> <p>G - Lutron - HI-LUME PREMIER 0,1% Eco System 24V/96W</p> <p>I - Casambi CBU-A2D-0/10V-DALI-Bluetooth 100/277 VAC</p> <p>J - Casambi CBU-PWM4-4CH-Bluetooth 100/277 VAC</p> <p>K - Casambi CBU-TED-CV-Trail edge dim-Bluetooth 120 VAC</p> <p>NO - No driver</p>	<b>Total length of LED engine in inches</b> - See Appendix 3 on how to calculate length.
COLOR TEMPERATURE CCT	LUMEN PACKAGE	LEAD IN    LEAD OUT	USAGE	POWER SUPPLY/CONTROL	LED ENGINE LENGTH
COLOR TEMPERATURE CCT	LUMEN PACKAGE	LEAD IN    LEAD OUT	USAGE	POWER SUPPLY/CONTROL	LED ENGINE LENGTH
COLOR TEMPERATURE CCT	LUMEN PACKAGE	LEAD IN    LEAD OUT	USAGE	POWER SUPPLY/CONTROL	LED ENGINE LENGTH

\*NOTE: The light output is provided in lumens per foot, for a CCT of 4200K and a clear lens. Please refer to the optics page for CCT and translucency conversion factors. \*\*Only available in 96W - 24V Driver

TITLE 24



# 9000 SERIES





# 9400 PROFILE

9000 Series



## Cross-section dimensions:

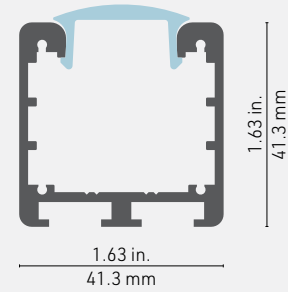

The **9400 profile** with its twin mounting channels allows for a **wide range of installation options**. Whether on swivel arms, on a surface, or suspended, it can be built in complex spatial configurations using **corner joiners**. Its rugged build in 6063-T5 aluminum alloy will withstand abuse in demanding applications and extreme weather, all of it with an understated elegance.

## FEATURES

- The ALCOA 6063-T5 aluminum alloy increases heat dissipation, for an extended lifetime of the LED source, and is suitable for outdoor installation.
- Custom length by sections of 2 to 240 inches (6m).
- 3 position slots for the LED heatsink insert for setting the needed beam angle.
- Accepts multiple or oversized LED sources on a 33mm (1.25in) wide area, for extra power. Has 3 application guides for 10mm (3/8-inch) wide LED engines.
- Designed to give a uniform light without hot spots.
- Its mounting channels make it compatible with a wide range of installation accessories.

## OPTIONS



## LED ENGINE COMPATIBILITY

Compatible with LED engines and PCBs up to **33mm** wide.

## LINEAR WEIGHT

























0.697 lbs/ft, 1.038 kg/m (without lens or insert)





# 9400 Profile ordering sheet

# 9000 Series

PROFILE	LENSES	MOUNTING HARDWARE	CANOPY	OPTION	LENGTH
 <p>9400 - Profile, Alu</p>	 <p>CL - Clear lens</p>	 <p>CLIP - Clip-in Bracket</p>	<p>NOTE: Only available with SUS bracket (suspension)</p>  <p>Remote driver canopy plate See Appendix 2 on page 158 CR0 - Alu CR1 - Black CR2 - White</p>	 <p>HER - High efficiency reflector</p>	<p>Custom length by sections of 6 to 240 inches (6m).</p>
 <p>9401 - Profile, Black</p>	 <p>OX - Optiflex lens</p>	 <p>Surface 2-side bracket S20 - Alu S21 - Black S22 - White</p>	 <p>Integrated driver in canopy See Appendix 2 on page 158 C10 - Alu C11 - Black C12 - White</p>	 <p>NO - No option</p>	
 <p>9402 - Profile, White</p>	 <p>OP - Opal Lens</p>	 <p>Surface 1-side bracket S10 - Alu S11 - Black S12 - White</p>	 <p>Integrated driver &amp; suspension kit See Appendix 2 on page 158 CIK0 - Alu CIK1 - Black CIK2 - White</p>		
 <p>940X - 9400 Profile, custom color</p> <p>IMPORTANT: Give RAL color № See Appendix 1 on page 158</p>	 <p>PR - Prime Lens</p>	 <p>Swivel wall bracket SW0 - Alu SW1 - Black SW2 - White</p>	 <p>NO - No canopy</p>		
RAL NUMBER	 <p>FO - Focus lens</p>	 <p>Swivel sign arm, 6° offset SA60 - Alu SA61 - Black SA62 - White</p>			
	 <p>NO - No lens</p>	 <p>Swivel sign arm, 18° offset SA180 - Alu SA181 - Black SA182 - White</p>			
		 <p>Type B dbl, chann, susp. kit with 15ft. aircraft cable SUS0 - Alu SUS1 - Black SUS2 - White</p>	 <p>NO - No mounting hardware</p>		

COLOR TEMPERATURE	LUMEN PACKAGE**	LEAD IN/OUT	USAGE	POWER SUPPLY/CONTROL	*NOTES
<p>24 - 2400K</p> <p>27 - 2700K</p> <p>30 - 3000K</p> <p>35 - 3500K</p> <p>42 - 4200K</p> <p>53 - 5300K (LHP only)</p> <p>62 - 6200K (LP only)</p> <p>WD1 - WarmDim 14W</p> <p>WD2 - WarmDim 17W</p> <p>TW1 - Tunable White 11W</p> <p>TW2 - Tunable White 19W</p> <p>RGB1 - RGB 14W</p> <p>RGB2 - RGB 19W</p> <p>RGBW1 - 3000K</p> <p>RGBW2 - 3000K 4in1</p>	<p>LP0 - 128 LM / 1.5W FT / 90+CRI</p> <p>LP1 - 160 LM / 1.5W FT / 90+CRI</p> <p>LP2 - 255 LM / 3.0W FT / 90+CRI</p> <p>LP3 - 308 LM / 4.5W FT / 90+CRI</p> <p>LP4 - 400 LM / 5.8W FT / 90+CRI</p> <p>LHP - 700 LM / 7.0W FT / 95+CRI</p> <p>Note: Not applicable for WarmDim, Tunable White &amp; RGB color temperatures</p>	<p>HW3 - Hardware 3 FT</p> <p>HW6 - Hardware 6 FT</p> <p>HW9 - Hardware 9 FT</p> <p>HWX - Hardware custom FT</p> <p>DC3 - DC plug 3 FT</p> <p>DC6 - DC plug 6 FT</p> <p>DC9 - DC plug 9 FT</p> <p>DCX - DC plug custom FT</p> <p>SUS - Coaxial wire 15 FT</p> <p>NO - No lead</p>	<p>I - IP22 indoor dry location</p> <p>O - IP68 wet/damp location</p>	<p>A - Non-dimming</p> <p>B - ELV dimming 120V AC</p> <p>C - ELV dimming 120/277 VAC***</p> <p>D - 0/10V dimming 120/277 VAC</p> <p>E - Non-dimming DC plug in</p> <p>F - DMX</p> <p>G - Lutron - HI-LUME PREMIER 0,1% Eco System 24V/96W</p> <p>I - Casambi CBU-A2D-0/10V-DALI-Bluetooth 100/277 VAC</p> <p>J - Casambi CBU-PWM4-4CH-Bluetooth 100/277 VAC</p> <p>K - Casambi CBU-TED-CV-Trail edge dim-Bluetooth 120 VAC</p> <p>NO - No driver</p>	<p>* Double strip option cannot be used with the reflector.</p> <p>**The light output is provided in lumens per foot, for a CCT of 4200K and a clear lens. Please refer to the optics page for CCT and translucency conversion factors.</p> <p>*** Only available in 96W - 24V Driver.</p>

SINGLE-STRIP 1 DOUBLE-STRIP 2\*

SINGLE STRIP DOUBLE STRIP

LEAD IN LEAD OUT

USAGE

POWER SUPPLY/CONTROL

# 9820 PROFILE

9000 Series

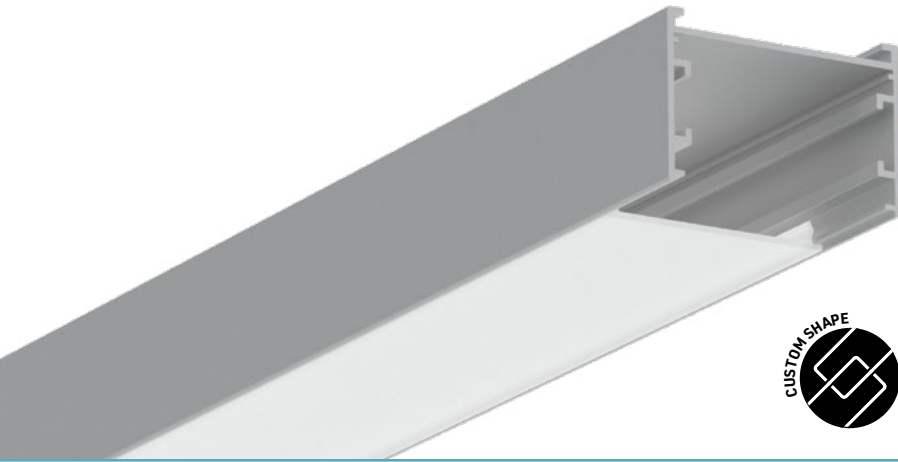

## Cross-section dimensions:

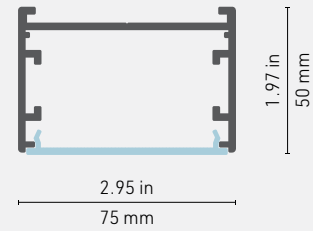

The 9820 is a 9000 series system designed for those looking for a minimalist effect. Its ultra-slim profile combined with our advanced LED technology make it a suitable solution to accentuate the geometric shapes of stairs, hallways, kitchen islands and much more.

With lengths of up to 16' (5000 mm), this profile gives you all the flexibility you need to realize ambitious lighting concepts.

## FEATURES

- Dimensions: 3" wide and 2" high.
- Customized length in sections from 2 to 192 in. (16 feet, 5 m) or with joiners for superior lengths or corner connections.
- Pre-made corner sections for easy assembly.
- Wide choice of color temperatures and standard LED engines.
- Made of ALCOA 6063-T5 aluminum alloy for superior heat dissipation and increased LED light source life.

## OPTIONS



## LED ENGINE COMPATIBILITY

Multiple standard LED engines can be installed up to a total width of **36mm**.

## LINEAR WEIGHT

0.793 lbs/ft, 1.18 kg/m

Figures provided for the aluminum profiles only – outer and inner enclosures, heatsink. The complete assembly, with LED light sources, reflectors, power supplies, endcaps, mounting hardware etc. will be greater, and will vary depending on product configuration.



HIGH EFFICIENCY  
REFLECTOR V2.1

# HER<sup>2</sup> PRO

Significantly improves  
luminous efficiency!

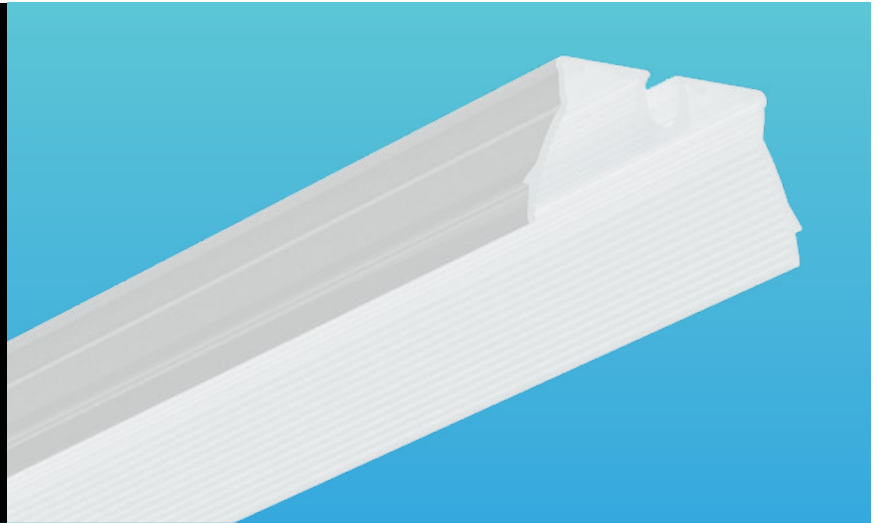





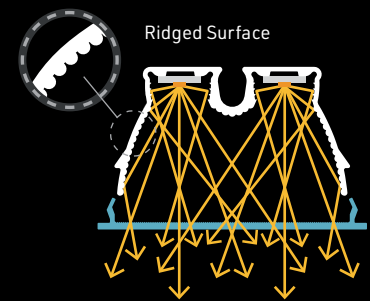



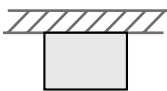

## HER PRO - HIGH EFFICIENCY REFLECTOR V2.1















Achieve maximum luminous flux with the **HER Pro** (High Efficiency Reflector)! With its engineered design, this new reflector significantly improves luminous efficiency and provides lighting without loss of light. An ingenious idea that surpasses the use of white reflective paint to maximize lighting. The Pro version has been designed with our brand new Reflective Wave System – ridges on each side of the reflector – that helps provide even greater illumination!





PROFILE	MOUNTING TYPE	LENSES	REFLECTOR	LENGTH
 <p>9820 - Alu</p>	 <p>S - Surface mount</p> <p>Note: Mounting hardware by others</p>	 <p>PR - Prime flat lens</p>	 <p>HER - High efficiency reflector</p>	<p>Custom length by sections of 2 to 192 inches.</p>
 <p>9821 - Black</p>		<b>INCLUDED</b>		
 <p>982X - Custom color</p> <p><b>IMPORTANT:</b> Give RAL color No See Appendix 1 on page 158</p>				

RAL NUMBER	MOUNTING TYPE	LENS	REFLECTOR	LENGTH	
	<b>S</b>	<b>PR</b>	<b>HER</b>		
	MOUNTING TYPE	LENS	REFLECTOR	LENGTH	
	 <p>JS - Type C straight joiner</p>	 <p>JH45 - Type C horiz. 45° joiner</p>	 <p>JH90 - Type C horiz. 90° joiner</p>	 <p>JV90 - Type C vert. 90° joiner</p>	 <p>JV45 - Type C vert. 45° joiner</p>
	QUANTITY	QUANTITY	QUANTITY	QUANTITY	QUANTITY

COLOR TEMPERATURE	LUMEN PACKAGE*	USAGE	POWER SUPPLY/CONTROL	*NOTES
<ul style="list-style-type: none"> <li> 24 - 2400K</li> <li> 27 - 2700K</li> <li> 30 - 3000K</li> <li> 35 - 3500K</li> <li> 42 - 4200K</li> <li> 53 - 5300K (LHP only)</li> <li> 62 - 6200K (LP only)</li> <li> WD1 - WarmDim 14W</li> <li> WD2 - WarmDim 17W</li> <li> TW1 - Tunable White 11W</li> <li> TW2 - Tunable White 19W</li> <li> RGB1 - RGB 14W</li> <li> RGB2 - RGB 19W</li> <li> RGBW1 - 3000K</li> <li> RGBW2 - 3000K 4in1</li> </ul>	<p>2LP0 - 256 LM / 1.5W FT / 90+CRI</p> <p>2LP1 - 320 LM / 1.5W FT / 90+CRI</p> <p>2LP2 - 510 LM / 3.0W FT / 90+CRI</p> <p>2LP3 - 616 LM / 4.5W FT / 90+CRI</p> <p>2LP4 - 800 LM / 5.8W FT / 90+CRI</p> <p>2LHP - 1400 LM / 7.0W FT / 95+CRI</p> <p><b>Note:</b> Not applicable for WarmDim, Tunable White &amp; RGB color temperatures</p>	<p>I - IP22 indoor dry location</p>	<p>A - Non-dimming</p> <p>B - ELV dimming 120V AC</p> <p>C - ELV dimming 120/277 VAC**</p> <p>D - 0/10V dimming 120/277 VAC</p> <p>E - Non-dimming DC plug in</p> <p>F - DMX</p> <p>G - Lutron - HI-LUME PREMIER 0,1% Eco System 24V/96W</p> <p>I - Casambi CBU-A2D-0/10V-DALI-Bluetooth 100/277 VAC</p> <p>J - Casambi CBU-PWM4-4CH-Bluetooth 100/277 VAC</p> <p>K - Casambi CBU-TED-CV-Trail edge dim-Bluetooth 120 VAC</p> <p>NO - No driver</p>	<p>*The light output is provided in lumens per foot, for a CCT of 4200K and a clear lens. Please refer to the optics page for CCT and translucency conversion factors.</p> <p>** Only available in 96W - 24V Driver</p> <div style="border: 1px solid gray; padding: 2px; text-align: center;"> <p>TITLE</p> <p><b>24</b></p> <p>COMP. LOGO</p> </div>
COLOR TEMPERATURE	LUMEN PACKAGE	<b>IP22</b>	POWER SUPPLY/CONTROL	

9000

# 9820 LUXLINE PROFILE

9000 Series

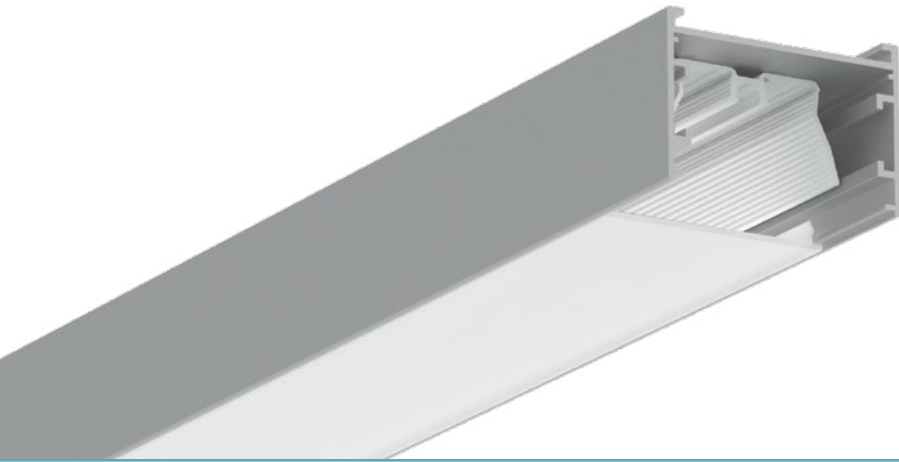

## Cross-section dimensions:

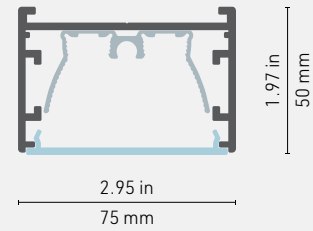

The 9820 is a 9000 series system designed for those looking for a minimalist effect. Its ultra-slim profile combined with our advanced LED technology make it a suitable solution to accentuate the geometric shapes of stairs, hallways, kitchen islands and much more.

## FEATURES

- Dimensions: 3" wide and 2" high
- Luminaire casing available in section from 24" to 96" (max total of 164')
- Wide choice of color temperatures (2400K - 4000K)
- ELV/Triac dimmable
- Black and aluminum casing available
- Blind covers on both sides to eliminate dark spots
- No driver needed: 120V LuxLine light source, available up to 164 ft., for use with the HER reflector that holds it in place and provides maximum luminance
- Can be installed directly on a 2"x3" junction box
- Pre-made corners with joiners available for L, U and square/rectangular shapes to assemble on site
- Made of ALCOA 6063-T5 aluminum alloy for superior heat dissipation and increased LED light source life

## OPTIONS



## LED ENGINE COMPATIBILITY

Compatible with two runs of our LuxLine series of 120V LED engine tape.

## LINEAR WEIGHT

0.793 lbs/ft, 1.18 kg/m

Figures provided for the aluminum profiles only – outer and inner enclosures, heatsink. The complete assembly, with LED light sources, reflectors, power supplies, endcaps, mounting hardware etc. will be greater, and will vary depending on product configuration.



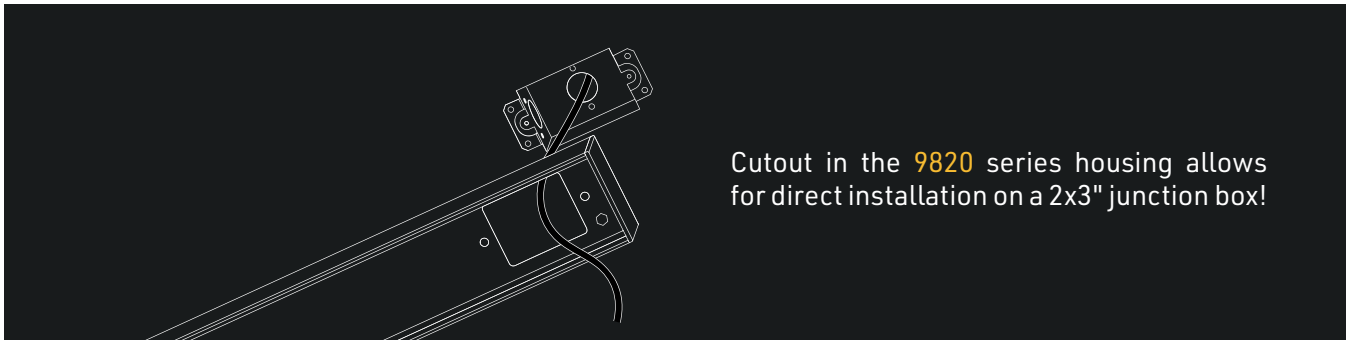

Cutout in the 9820 series housing allows for direct installation on a 2x3" junction box!

HIGH EFFICIENCY REFLECTOR V2.1

# HER<sup>2</sup> PRO

Significantly improves luminous efficiency!

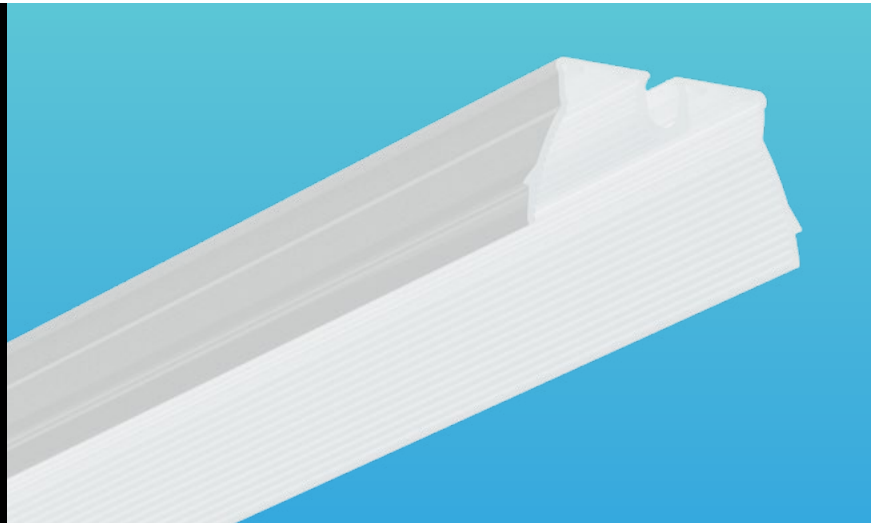





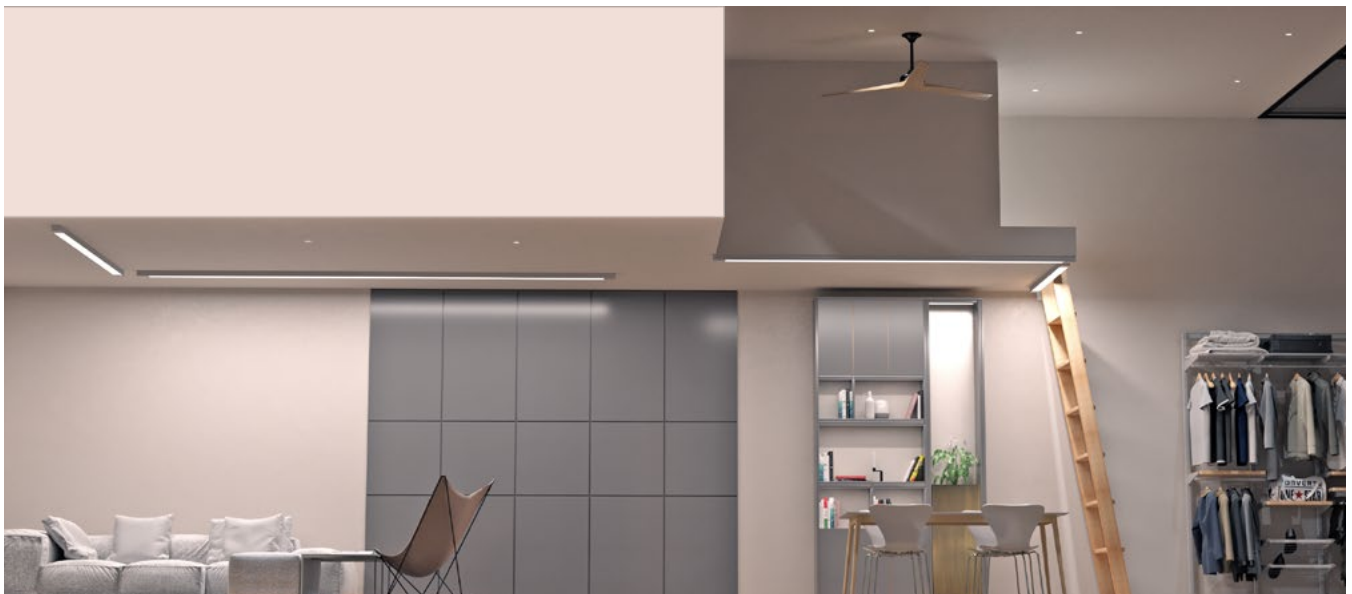
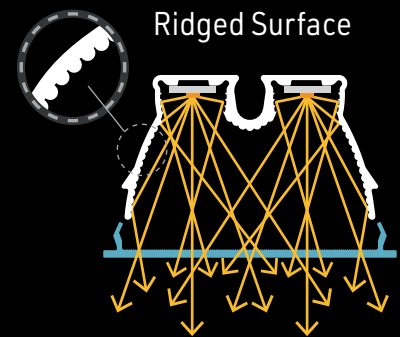

## HER PRO - HIGH EFFICIENCY REFLECTOR V2.1



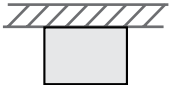

Achieve maximum luminous flux with the **HER Pro** (High Efficiency Reflector)! With its engineered design, this new reflector significantly improves luminous efficiency and provides lighting without loss of light. An ingenious idea that surpasses the use of white reflective paint to maximize lighting. The Pro version has been designed with our brand new Reflective Wave System – ridges on each side of the reflector – that helps provide even greater illumination!











PROFILE	MOUNTING TYPE	LENSES	REFLECTOR	BLIND COVERS	LENGTH
 <p>9820 - Alu</p>	 <p>S - Surface mount</p> <p>Note: Mounting hardware by others</p>	 <p>PR - Prime flat lens</p>	 <p>HER - High efficiency reflector</p>	 <p>BC2 - 2 covers of 4" on both sides</p>	<p>Custom length by sections of 24 to 192 inches.</p>
 <p>9821 - Black</p>					
 <p>982X - Custom color</p> <p><b>IMPORTANT:</b> Give RAL color No See Appendix 1 on page 158</p>					

RAL NUMBER	PROFILE	MOUNTING TYPE	LENS	REFLECTOR	BLIND COVERS	LENGTH
		<b>S</b>	<b>PR</b>	<b>HER</b>	<b>BC2</b>	
	 <p>JS - Type C straight joiner</p>	 <p>JH45 - Type C horiz. 45° joiner</p>	 <p>JH90 - Type C horiz. 90° joiner</p>	 <p>JV90 - Type C vert. 90° joiner</p>	 <p>JV45 - Type C vert. 45° joiner</p>	
	QUANTITY	QUANTITY	QUANTITY	QUANTITY	QUANTITY	

COLOR TEMPERATURE	LUMEN PACKAGE*	LEAD IN	USAGE	*NOTES
<ul style="list-style-type: none"> <li> 24 - 2400K</li> <li> 27 - 2700K</li> <li> 30 - 3000K</li> <li> 35 - 3500K</li> <li> 42 - 4000K</li> </ul>	2LUX - 700 LM / 8.0W FT / 90+CRI	HW - Hardwire 118"	2 - IP65 indoor	<p>The light output is provided in lumens per foot, for a CCT of 4200K and a clear lens. Please refer to the optics page for CCT and translucency conversion factors.</p> <div style="border: 1px solid black; padding: 2px; width: fit-content;"> <p>TITLE <b>24</b> www.lumentruss.com</p> </div>
COLOR TEMPERATURE	<b>2LUX</b>	LEAD IN	<b>IP65</b>	

### LUXLINE FEATURES

- LumenTruss Driverless technology.
- Direct line voltage.
- Constant current IC providing uniform intensity over the entire run.
- Uses North American power plug with built-in fuse or hardwire.
- Order in lengths of 1 FT.
- 164 FT maximum run.
- Ultra high lumen output.
- Architectural grade.
- PVC coating (not recommended for direct sunlight).
- 3 year warranty.
- Life of 50,000 hours
- LED type: 3056
- WARNING: Do not cut AC plug.

### LUXLINE FEATURES

Plug-in Connection Diagram

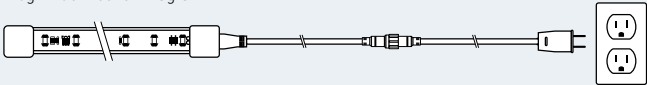

Hardwire Connection Diagram

**With the NEW revolutionary hardwire connection with built-in fuse! Exclusive to LumenTruss.**



# 9820 PRO PROFILE

9000 Series

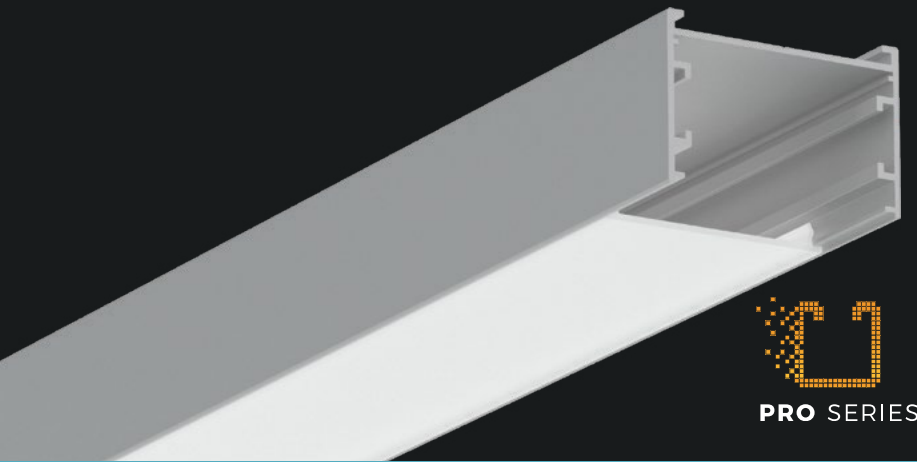

Cross-section dimensions:

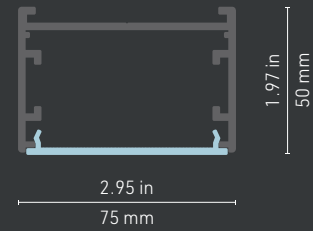

The 9820 is a 9000 series system designed for those looking for a minimalist effect. Its ultra-slim profile combined with our advanced LED technology make it a suitable solution to accentuate the geometric shapes of stairs, hallways, kitchen islands and much more.

## FEATURES

- Dimensions: 3" wide and 2" high
- Luminaire available in 3', 4', 5', 6', 8'
- Integrated driver for simple electrical connection
- Can be installed directly on a 2"x3" junction box
- Wide choice of fix color temperatures (2400K - 6200K)
- Two WarmDim options : 2200K-2900K and 2700K - 3500K
- ELV/Triac dimmable
- Black and aluminum casing available
- Blind cover on one side only, or blind cover on both sides
- Made of ALCOA 6063-T5 aluminum alloy for superior heat dissipation and increased LED light source life.

## OPTIONS



## LINEAR WEIGHT

0.793 lbs/ft, 1.18 kg/m

Figures provided for the aluminum profiles only – outer and inner enclosures, heatsink. The complete assembly, with LED light sources, reflectors, power supplies, endcaps, mounting hardware etc. will be greater, and will vary depending on product configuration.

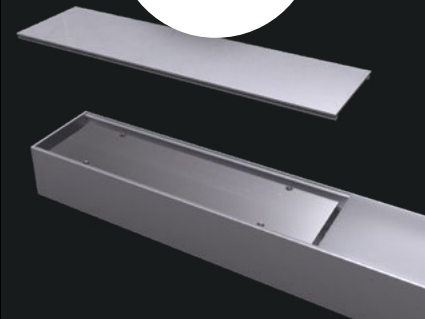

**9820 PRO** series can be directly installed on a 2x3" junction box.

HIGH EFFICIENCY  
REFLECTOR V2.1

# HER<sup>2</sup> PRO

Significantly improves  
luminous efficiency!

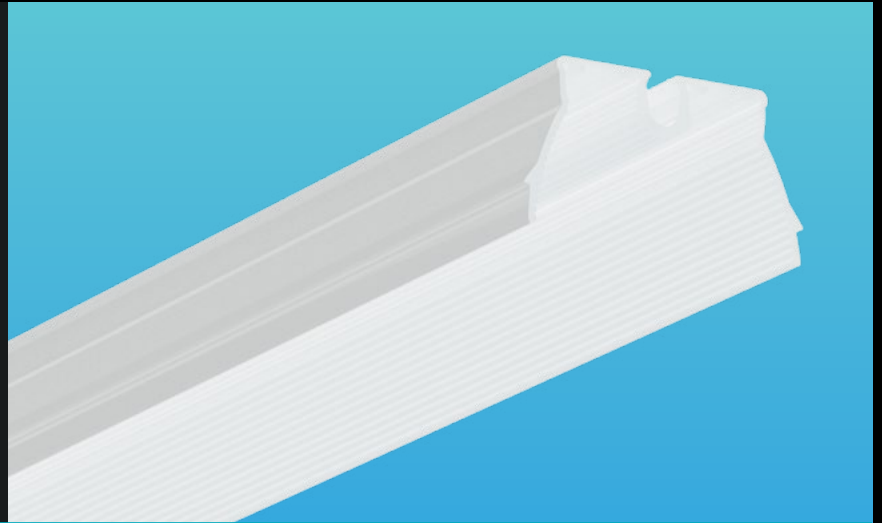

## HER PRO - HIGH EFFICIENCY REFLECTOR V2.1

Achieve maximum luminous flux with the **HER Pro** (High Efficiency Reflector)! With its engineered design, this new reflector significantly improves luminous efficiency and provides lighting without loss of light. An ingenious idea that surpasses the use of white reflective paint to maximize lighting. The Pro version has been designed with our brand new Reflective Wave System – ridges on each side of the reflector – that helps provide even greater illumination!

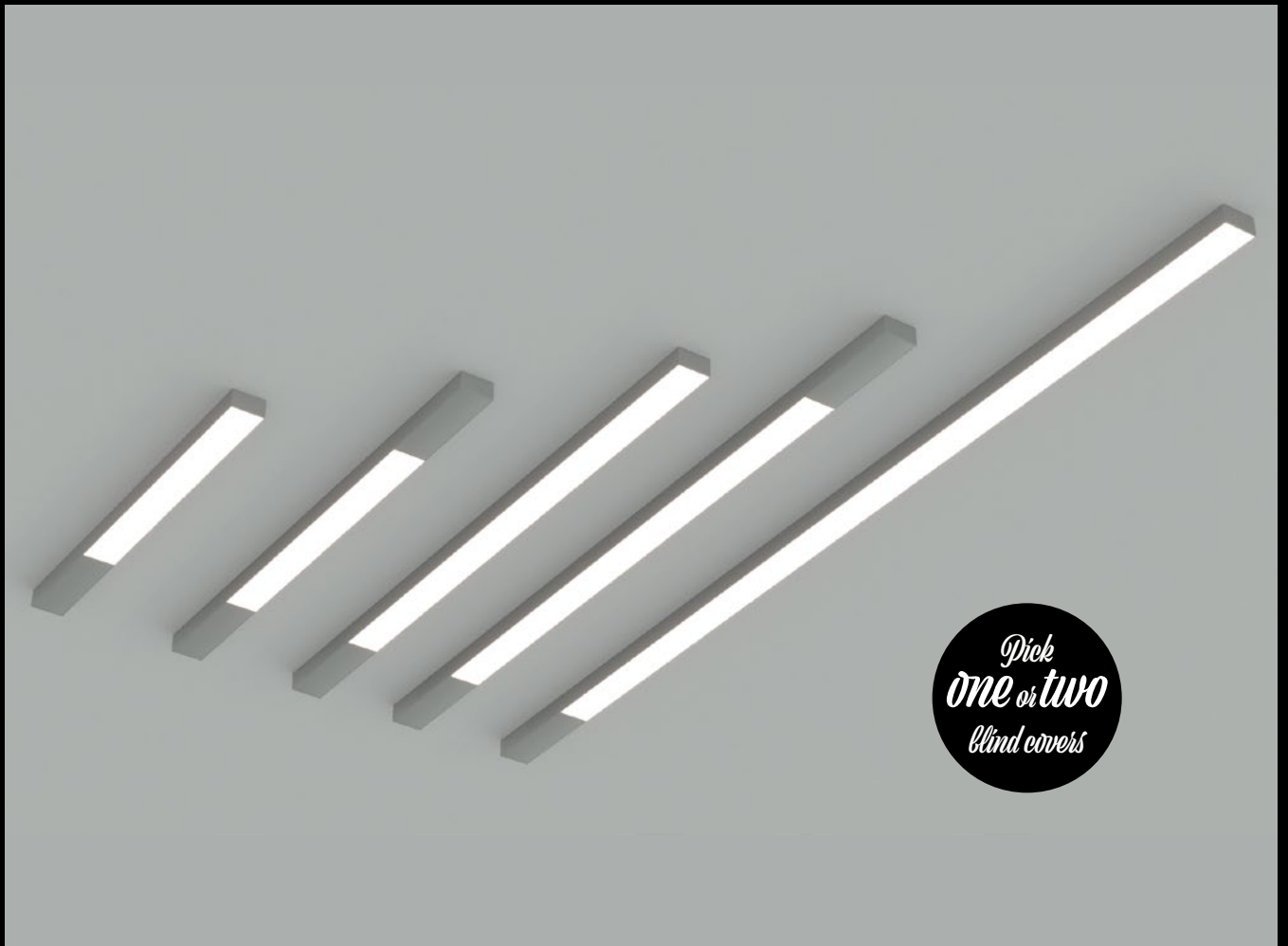
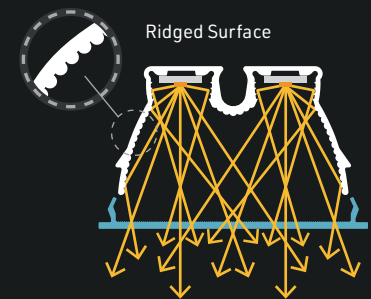

*Pick  
one or two  
blind covers*

# CASAMBI

The Casambi lighting control solution provides all the control options that are expected from a full featured professional lighting control solution.



PART OF OUR  
**PRO SERIES**



## A BIG VARIETY OF POSSIBILITIES

The app for smartphones, tablets and smartwatches is the most elaborated user interface. Besides the app, traditional wall switches, push buttons, Casambi's own scene controllers and many other control points can be used. Available for ios and Android devices.



## CASAMBI FUNCTIONALITY



### LIGHT COLOUR

A user can change the colour in a simple manner from the app and also save his/her favorite colours in a colour palette.



### SUNRISE & SUNSET

Casambi units are able to calculate the the local sunrise and sunset times.



### CALENDAR & TIMER

With the calendar and timer, scenes and animations can be turned on and off based on a convenient time or date.



### COLOUR TEMPERATURE

Casambi offers a comprehensive colour temperature control. A user can change the CCT just by sliding the finger on top of an icon.



### GROUPING

After grouping, all the luminaires in the group can be controlled all together or the group can be opened for individual control.



### SCENES

Different lighting situations for different occasions can be created. It is possible to control multiple luminaires with one tap.









### DAYLIGHT SENSOR

The control solution allows dimming of artificial lighting when daylight is available for achieving maximum lighting quality.



### OCCUPANCY SENSOR







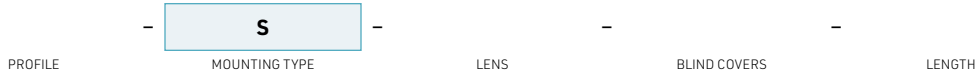



The Casambi lighting control system supports movement sensors, also overlapping movement sensor information

PROFILE	MOUNTING TYPE	LENSES	BLIND COVERS	LENGTH
 <b>9820</b> - Alu	 <b>S</b> - Surface mount Note: Mounting hardware by others	 <b>PR</b> - Prime flat lens	 <b>BC1</b> - 1 cover on the driver side <b>BC2</b> - 2 covers on both sides Note: Blind covers are the same color as profile casing.	<b>36</b> = 36" <b>48</b> = 48" <b>60</b> = 60" <b>72</b> = 72" <b>96*</b> = 96" *Not available for LP4 and LHP Lumen Packages
 <b>9821</b> - Black		 <b>BK</b> - Black flat lens		
 <b>982X</b> - Custom color IMPORTANT: Give RAL color No See Appendix 1 on page 158				Custom length available, call to order.

RAL NUMBER



9000

COLOR TEMPERATURE	LUMEN PACKAGE*	USAGE	POWER SUPPLY/CONTROL	*NOTES
<ul style="list-style-type: none"> <li> 24 - 2400K</li> <li> 27 - 2700K</li> <li> 30 - 3000K</li> <li> 35 - 3500K</li> <li> 42 - 4200K</li> <li> 53 - 5300K (LHP only)</li> <li> 62 - 6200K (LP only)</li> <li> <b>WD1</b> - 2200-2900K</li> <li> <b>WD2</b> - 2700-3500K</li> </ul>	<b>2LP3</b> - 616 LM / 9.0W FT / 90+CRI <b>2LP4</b> - 800 LM / 10.6W FT / 90+CRI <b>2LHP</b> - 1400 LM / 14.0W FT / 95+CRI Note: Not applicable for WarmDim color temperatures Note: LP4 and LHP Lumen Packages are available for luminaires up to 6'.	<b>I</b> - IP22 indoor dry location	<b>B</b> - ELV dimming 120V AC <b>K</b> - Casambi CBU-TED-CV-Trail edge dim-Bluetooth 120 VAC	*The light output is provided in lumens per foot, for a CCT of 4200K and a clear lens. Please refer to the optics page for CCT and translucency conversion factors. ** Only available in 96W - 24V Driver 
COLOR TEMPERATURE	LUMEN PACKAGE	<b>IP22</b>	POWER SUPPLY/CONTROL	

# 9850 PROFILE

9000 Series



## Cross-section dimensions:

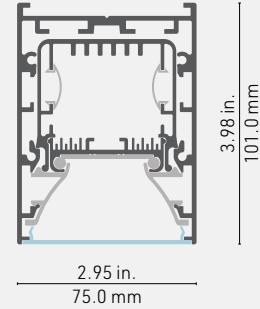

The 9850 Profile is a 9000 series linear luminaire system designed to be suspended. With its minimalistic style, it is robust and powerful. Multiple standard LED light engines can be installed **up to 36 mm** wide for maximum power. It is equipped with an Optiflex (frosted) lens that scatters light evenly, dot-free, in a 120-degree beam. Easy installation for a finish without visible screws: an exclusive feature of LumenTruss™!

## FEATURES

- Dimensions: 3" wide and 4" high.
- Customized length in sections from 2 to 240 in. (20 feet, 6 m) or with connectors for longer lengths or corner connections.
- Wide choice of color temperatures and standard LED engines.
- Made of ALCOA 6063-T5 aluminum alloy for superior heat dissipation and increased LED light source life.
- Finish without visible screws with strong magnetic endcaps.
- Suspension cables can be installed anywhere on top of the luminaire for greater installation flexibility.

## OPTIONS



## LED ENGINE COMPATIBILITY

Multiple standard LED engines can be installed up to a total width of **36mm**.

## LINEAR WEIGHT

2.863 lbs/ft, 4.261 kg/m

Figures provided for the aluminum profiles only – outer and inner enclosures, heatsink. The complete assembly, with LED light sources, reflectors, power supplies, endcaps, mounting hardware etc. will be greater, and will vary depending on product configuration.



### PROFILE ASSEMBLY



**9850** - Down profile assembly, Alu

### MOUNTING HARDWARE



Suspension kit with 15ft. aircraft cable  
**SUS0** - Stainless  
**SUS1** - Black

### CANOPY



**Remote driver canopy plate**  
 See Appendix 2 on page 158  
**CR0** - Alu  
**CR1** - Black  
**CR2** - White



**Integrated driver in canopy**  
 See Appendix 2 on page 158  
**CI0** - Alu  
**CI1** - Black  
**CI2** - White



**Integrated driver & suspension kit**  
 See Appendix 2 on page 158  
**CIK0** - Alu  
**CIK1** - Black  
**CIK2** - White



**NO** - No canopy

Custom length by sections of 2 to 240 inches.

PROFILE ASSEMBLY

MOUNTING HARDWARE

CANOPY

LENGTH

### COLOR TEMPERATURE

- 24** - 2400K
- 27** - 2700K
- 30** - 3000K
- 35** - 3500K
- 42** - 4200K
- 53** - 5300K (LHP only)
- 62** - 6200K (LP only)
- WD1** - WarmDim 14W
- WD2** - WarmDim 17W
- TW1** - Tunable White 11W
- TW2** - Tunable White 19W
- RGB1** - RGB 14W
- RGB2** - RGB 19W
- RGBW1** - 3000K
- RGBW2** - 3000K 4in1

### LUMEN PACKAGE\*

- LP0** - 128 LM / 1.5W FT / 90+CRI
  - LP1** - 160 LM / 1.5W FT / 90+CRI
  - LP2** - 255 LM / 3.0W FT / 90+CRI
  - LP3** - 308 LM / 4.5W FT / 90+CRI
  - LP4** - 400 LM / 5.8W FT / 90+CRI
  - LHP** - 700 LM / 7.0W FT / 95+CRI
- Note:** Not applicable for WarmDim, Tunable White & RGB color temperatures

### USAGE

- I** - IP22 indoor dry location

### POWER SUPPLY/CONTROL

- A** - Non-dimming
- B** - ELV dimming 120V AC
- C** - ELV dimming 120/277 VAC\*\*
- D** - 0/10V dimming 120/277 VAC
- E** - Non-dimming DC plug in
- F** - DMX
- G** - Lutron - HI-LUME PREMIER 0,1% Eco System 24V/96W
- I** - Casambi CBU-A2D-0/10V-DALI-Bluetooth 100/277 VAC
- J** - Casambi CBU-PWM4-4CH-Bluetooth 100/277 VAC
- K** - Casambi CBU-TED-CV-Trail edge dim-Bluetooth 120 VAC
- NO** - No driver

### \*NOTES

\*The light output is provided in lumens per foot, for a CCT of 4200K and a clear lens. Please refer to the optics page for CCT and translucency conversion factors.

\*\* Only available in 96W - 24V Driver



**IP22**

1 STRIP 2 STRIPS 3 STRIPS

1 STRIP 2 STRIPS 3 STRIPS

USAGE

POWER SUPPLY/CONTROL



**PVC SERIES**





# LUXSLEEVE PROFILE

PVC Series



## Cross-section dimensions:

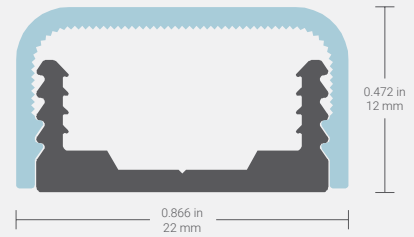

Looking for mood light without breaking the bank? This PVC extrusion sleeve allows for better light diffusion while being the most economical option for our LuxLine series. Available in 8', you can easily cut it to design ambient light in so many ways. Making dark spaces more inviting has never been so easy.

## FEATURES

- Simple and lightweight extrusion made of durable PVC material
- Economical and long lasting
- Two lens options available: Prime or Clear
- Fine grooves on the inner surface of the lens provide even and effective light distribution
- Wide variety of color temperatures available (2400 - 4000K)
- Perfect solution for accent lighting
- Grooves on the extrusion surface provide perfect grip for our LuxLine 120V LED tape
- Easy to cut and install, no mounting brackets required
- Available in straight sections of 8' (2.4m)

## LED ENGINE COMPATIBILITY

Compatible with LuxLine 120V LED engines.



## LINEAR WEIGHT

0.1 lbs/ft, 0.16 kg/m (with lens)

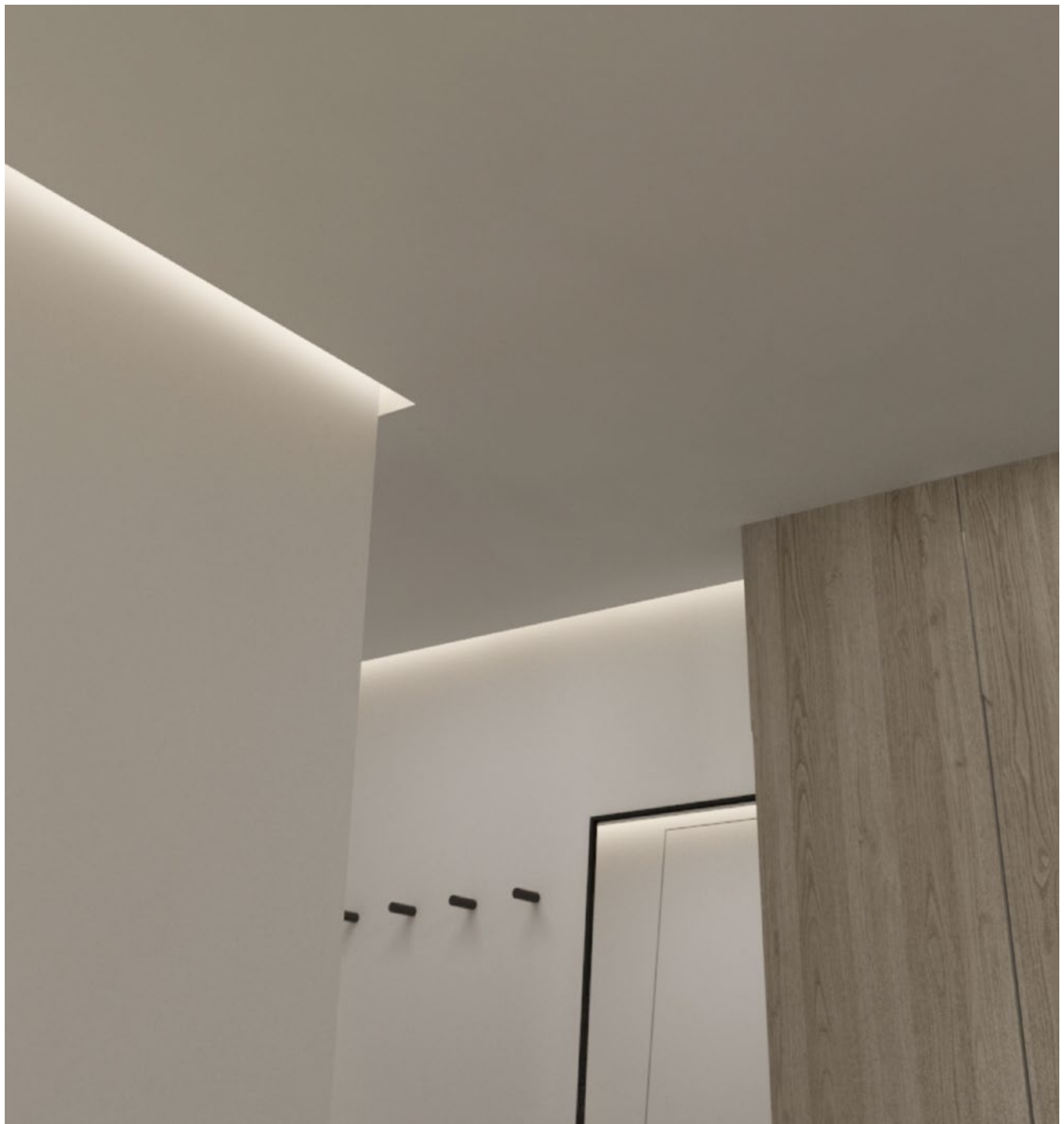
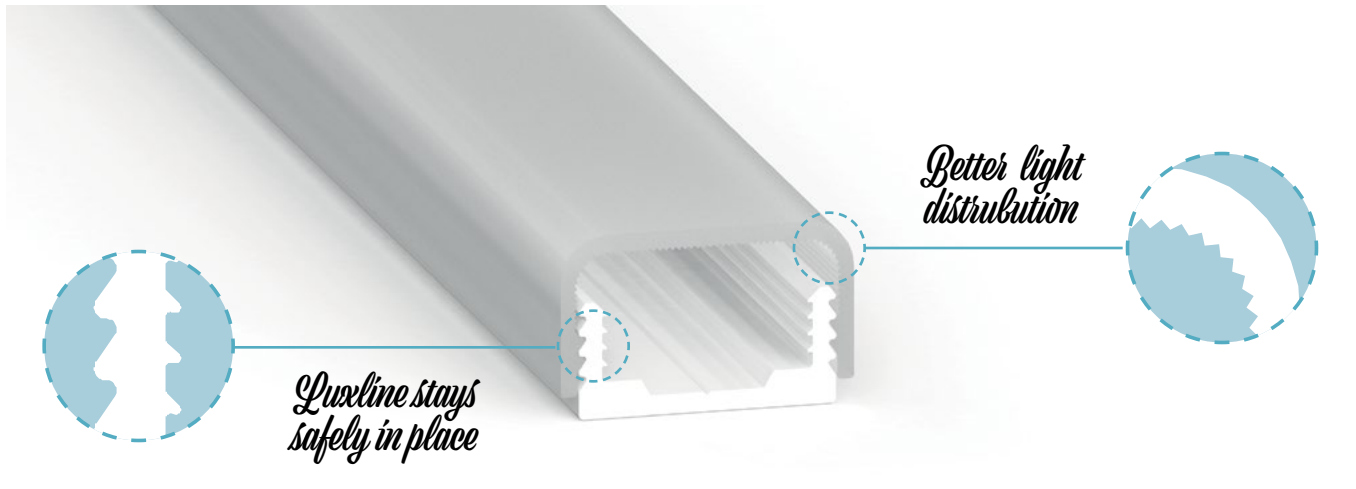











LENSES	PROFILE	LENGTH
 <p>LSPR - Prime lens</p>	 <p>LuxSleeve, PVC Series, white</p> <p><b>INCLUDED</b></p>	<p>Available in straight section of 8 feet (96 inches/2.4 m). *Cut on site</p>
 <p>LSCL - Clear lens</p>		

LENS	-	QUANTITY	X	<b>96 INCHES</b>	LENGTH
------	---	----------	---	------------------	--------

COLOR TEMPERATURE	LUMEN PACKAGE*	LEAD IN/OUT	JUMPER	USAGE	*NOTES
 24 - 2400K  27 - 2700K  30 - 3000K  35 - 3500K  42 - 4000K	LUX - 350 LM / 4.0W FT / 90+CRI	PG - Plug-in 47" HW - Hardwire 118"	JP6 - Jumper 6" JP12 - Jumper 12" NO - No jumper	2 - IP65 indoor	The light output is provided in lumens per foot, for a CCT of 4200K and a clear lens. Please refer to the optics page for CCT and translucency conversion factors.  

COLOR TEMPERATURE CCT	-	<b>LUX</b>	-	LEAD IN	LEAD OUT	-	<b>IP65</b>	QTY
-----------------------	---	------------	---	---------	----------	---	-------------	-----

### LUXLINE FEATURES

- LumenTruss Driverless technology.
- Direct line voltage.
- Constant current IC providing uniform intensity over the entire run.
- Uses North American power plug with built-in fuse or hardwire.
- Order in lengths of 1 FT.
- 164 FT maximum run.
- Ultra high lumen output.
- Architectural grade.
- PVC coating (not recommended for direct sunlight).
- 3 year warranty.
- Life of 50,000 hours
- LED type: 3056
- WARNING: Do not cut AC plug.

### LUXLINE FEATURES

Plug-in Connection Diagram

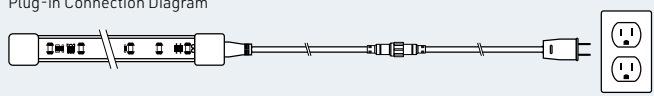

Hardwire Connection Diagram

**With the NEW revolutionary hardwire connection with built-in fuse! Exclusive to LumenTruss.**





# WOOD SERIES





# TIGA

Wood Series



## Cross-section dimensions:

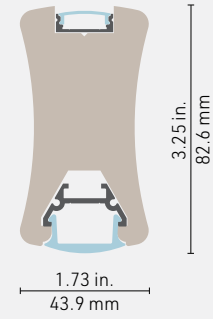

Go for the warmth of the **natural essence of wood**. Liven up your spaces with our ecological lighting fixtures made of recycled wood from Quebec. The slim **TIGA** will match any décor with its smoothed out sides, and can be combined with a linear canopy for extra style.

## FEATURES

- Engineered from sustainably harvested and recycled hardwood, for superior mechanical quality and to bring out the natural wood texture.
- Designed to give a uniform light without hot spots with an optiflex, opal or prime lens.
- Custom length by sections of 2 to 144 inches (3.6m).
- Application guide for 10mm (3/8-inch) LED engine or less.
- The insert is made of ALCOA 6063-T5 aluminum alloy increasing heat dissipation.
- Available in oiled finish, or in custom wood essences and tints.

## OPTIONS



## LED ENGINE COMPATIBILITY















Compatible with LED engines or PCBs up to **14mm** wide.

## LINEAR WEIGHT

1.141 lbs/ft, 1.699 kg/m (without lens or insert)





PROFILE	LENS DOWN	LENS UP	MOUNTING HARDWARE	CANOPY	LENGTH
 <p><b>TIGO</b> - Wood enclosure, Oiled finish Alu heatsink included with profile</p>	 <p><b>CL</b> - Clear lens</p>  <p><b>OX</b> - Optiflex lens</p>  <p><b>OP</b> - Opal lens</p>  <p><b>PR</b> - Prime lens</p> <p><b>NO</b> - No Lens</p>	 <p><b>CL</b> - Clear lens</p>  <p><b>SP</b> - Spread lens</p>  <p><b>OX</b> - Optiflex lens</p>  <p><b>OP</b> - Opal lens</p>  <p><b>PR</b> - Prime lens</p> <p><b>NO</b> - No lens</p>	 <p><b>SUS</b> - Suspension kit with 15ft. aircraft cable</p>	 <p><b>Remote driver canopy plate</b> See Appendix 2 on page 158 <b>CR0</b> - Alu <b>CR1</b> - Black <b>CR2</b> - White</p>  <p><b>Integrated driver in canopy</b> See Appendix 2 on page 158 <b>CI0</b> - Alu <b>CI1</b> - Black <b>CI2</b> - White</p>  <p><b>Integrated driver &amp; suspension kit</b> See Appendix 2 on page 158 <b>CIK0</b> - Alu <b>CIK1</b> - Black <b>CIK2</b> - White</p> <p><b>NO</b> - No canopy</p>	<p>Custom length by sections of 12 to 144 inches (3.6m), in increments of 12 inches (30cm).</p> <p>By default suspension will be installed 6 inches (15.3cm) from the ends of the profile. For custom options please contact your local representative.</p>
<b>TIGO</b>			<b>SUS</b>		
PROFILE	LENS DOWN	LENS UP	MOUNTING HARDWARE	CANOPY	LENGTH

COLOR TEMPERATURE	LM PACKAGE DOWN/UP*	USAGE	POWERSUPPLY/CONTROL**	*NOTES	
<p><b>24</b> - 2400K</p> <p><b>27</b> - 2700K</p> <p><b>30</b> - 3000K</p> <p><b>35</b> - 3500K</p> <p><b>42</b> - 4200K</p> <p><b>53</b> - 5300K (LHP only)</p> <p><b>62</b> - 6200K (LP only)</p> <p><b>WD1</b> - WarmDim 14W</p> <p><b>WD2</b> - WarmDim 17W</p> <p><b>TW1</b> - Tunable White 11W</p> <p><b>TW2</b> - Tunable White 19W</p> <p><b>RGB1</b> - RGB 14W</p> <p><b>RGB2</b> - RGB 19W</p> <p><b>RGBW1</b> - 3000K</p> <p><b>RGBW2</b> - 3000K 4in1</p> <p><b>NO</b> - No up light (w/ opal lens)</p>	<p><b>LP0</b> - 128 LM / 1.5W FT / 90+CRI</p> <p><b>LP1</b> - 160 LM / 1.5W FT / 90+CRI</p> <p><b>LP2</b> - 255 LM / 3.0W FT / 90+CRI</p> <p><b>LP3</b> - 308 LM / 4.5W FT / 90+CRI</p> <p><b>LP4</b> - 400 LM / 5.8W FT / 90+CRI</p> <p><b>LHP</b> - 700 LM / 7.0W FT / 95+CRI</p> <p><b>Note:</b> Not applicable for Warmdim, Tunable White &amp; RGB color temperatures</p>	<p><b>I</b> - IP22 indoor dry location</p>	<p><b>A</b> - Non-dimming</p> <p><b>B</b> - ELV dimming 120V AC</p> <p><b>C</b> - ELV dimming 120/277 VAC***</p> <p><b>D</b> - 0/10V dimming 120/277 VAC</p> <p><b>E</b> - Non-dimming DC plug in</p> <p><b>F</b> - DMX</p> <p><b>G</b> - Lutron - HI-LUME PREMIER 0,1% Eco System 24V/96W</p> <p><b>I</b> - Casambi CBU-A2D-0/10V-DALI-Bluetooth 100/277 VAC</p> <p><b>J</b> - Casambi CBU-PWM4-4CH-Bluetooth 100/277 VAC</p> <p><b>K</b> - Casambi CBU-TED-CV-Trail edge dim-Bluetooth 120 VAC</p> <p><b>NO</b> - No driver</p>	<p>* The light output is provided in lumens per foot, for a CCT of 4200K and a clear lens. Please refer to the optics page for CCT and translucency conversion factors.</p> <p>** By default both Up &amp; Down LED engines are controlled from one source. For custom options, please contact your local representative.</p> <p>*** Only available in 96W - 24V Driver</p> <div style="border: 1px solid black; padding: 5px; display: inline-block;"> <p>TITLE <b>24</b> CONVERSION</p> </div>	
CCT DOWN	CCT UP	LM DOWN	LM UP	USAGE	POWER SUPPLY/CONTROL

# TOOBYFOR

Wood Series



## Cross-section dimensions:

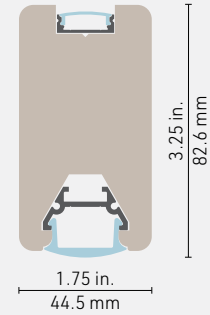

The **simplicity and minimalism** of **TOOBYFOR** makes it a welcome accent in contemporary spaces. Like the rest of our Wood Series, it is engineered from recycled hardwood, for natural warmth and superior quality. It is durable with its rugged build and an aircraft-grade suspension cable, but brings a lightweight and modern touch to any interior.

## FEATURES

- Engineered from sustainably harvested and recycled hardwood, for superior mechanical quality and to bring out the natural wood texture.
- Designed to give a uniform light without hot spots with an optiflex, opal or prime lens.
- Custom length by sections of 2 to 144 inches (3.6m).
- Application guide for 10mm (3/8-inch) LED engine or less.
- The insert is made of ALCOA 6063-T5 aluminum alloy increasing heat dissipation.
- Available in oiled finish, or in custom wood essences and tints.

## OPTIONS











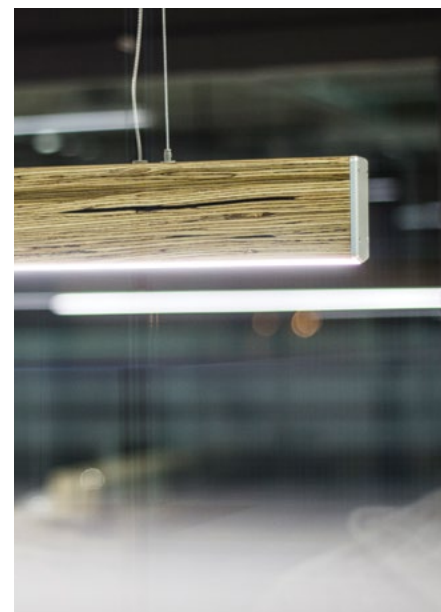
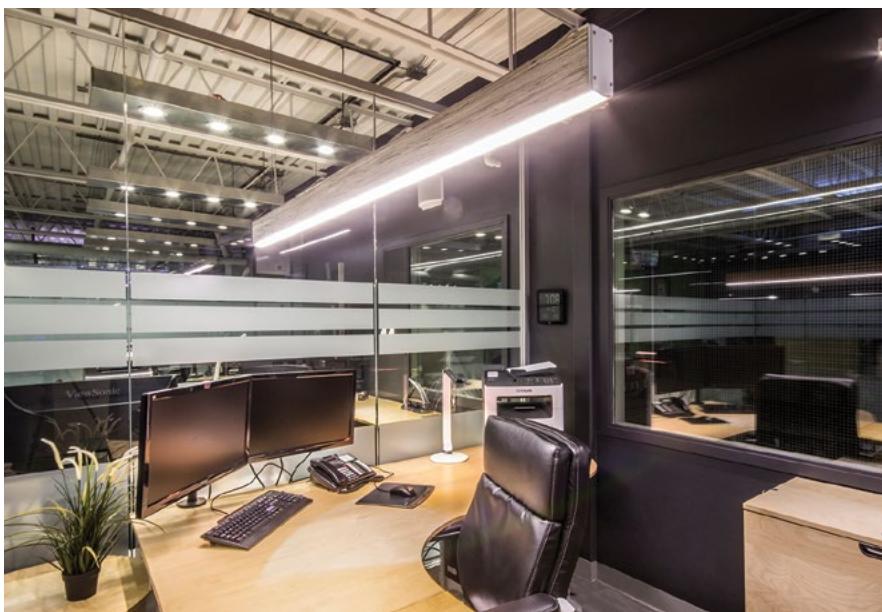





## LED ENGINE COMPATIBILITY

Compatible with LED engines or PCBs up to **14mm** wide.

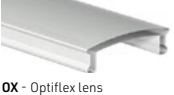
## LINEAR WEIGHT

1.385 lbs/ft, 2.060 kg/m (without lens or insert)



PROFILE	LENS DOWN	LENS UP	MOUNTING HARDWARE	CANOPY	LENGTH
 <p><b>T000</b> - Wood enclosure, Oiled finish Alu heatsink included with profile</p>	 <p><b>CL</b> - Clear lens</p>  <p><b>OX</b> - Optiflex lens</p>  <p><b>OP</b> - Opal lens</p>  <p><b>PR</b> - Prime lens</p> <p><b>NO</b> - No Lens</p>	 <p><b>CL</b> - Clear lens</p>  <p><b>SP</b> - Spread lens</p>  <p><b>OX</b> - Optiflex lens</p>  <p><b>OP</b> - Opal lens</p>  <p><b>PR</b> - Prime lens</p> <p><b>NO</b> - No lens</p>	 <p><b>SUS</b> - Suspension kit with 15ft. aircraft cable</p>	 <p><b>Remote driver canopy plate</b> See Appendix 2 on page 158 <b>CR0</b> - Alu <b>CR1</b> - Black <b>CR2</b> - White</p>  <p><b>Integrated driver in canopy</b> See Appendix 2 on page 158 <b>CI0</b> - Alu <b>CI1</b> - Black <b>CI2</b> - White</p>  <p><b>Integrated driver &amp; suspension kit</b> See Appendix 2 on page 158 <b>CIK0</b> - Alu <b>CIK1</b> - Black <b>CIK2</b> - White</p> <p><b>NO</b> - No canopy</p>	<p>Custom length by sections of 12 to 144 inches (3.6m), in increments of 12 inches (30cm).</p> <p>By default suspension will be installed 6 inches (15.3cm) from the ends of the profile. For custom options please contact your local representative.</p>
<b>T000</b>			<b>SUS</b>		
PROFILE	LENS DOWN	LENS UP	MOUNTING HARDWARE	CANOPY	LENGTH

COLOR TEMPERATURE	LM PACKAGE DOWN/UP*	USAGE	POWERSUPPLY/CONTROL**	*NOTES
<p><b>24</b> - 2400K</p> <p><b>27</b> - 2700K</p> <p><b>30</b> - 3000K</p> <p><b>35</b> - 3500K</p> <p><b>42</b> - 4200K</p> <p><b>53</b> - 5300K (LHP only)</p> <p><b>62</b> - 6200K (LP only)</p> <p><b>WD1</b> - WarmDim 14W</p> <p><b>WD2</b> - WarmDim 17W</p> <p><b>TW1</b> - Tunable White 11W</p> <p><b>TW2</b> - Tunable White 19W</p> <p><b>RGB1</b> - RGB 14W</p> <p><b>RGB2</b> - RGB 19W</p> <p><b>RGBW1</b> - 3000K</p> <p><b>RGBW2</b> - 3000K 4in1</p> <p><b>NO</b> - No up light (w/ opal lens)</p>	<p><b>LP0</b> - 128 LM / 1.5W FT / 90+CRI</p> <p><b>LP1</b> - 160 LM / 1.5W FT / 90+CRI</p> <p><b>LP2</b> - 255 LM / 3.0W FT / 90+CRI</p> <p><b>LP3</b> - 308 LM / 4.5W FT / 90+CRI</p> <p><b>LP4</b> - 400 LM / 5.8W FT / 90+CRI</p> <p><b>LHP</b> - 700 LM / 7.0W FT / 95+CRI</p> <p><b>Note:</b> Not applicable for Warmdim, Tunable White &amp; RGB color temperatures</p>	<p><b>I</b> - IP22 indoor dry location</p>	<p><b>A</b> - Non-dimming</p> <p><b>B</b> - ELV dimming 120V AC</p> <p><b>C</b> - ELV dimming 120/277 VAC***</p> <p><b>D</b> - 0/10V dimming 120/277 VAC</p> <p><b>E</b> - Non-dimming DC plug in</p> <p><b>F</b> - DMX</p> <p><b>G</b> - Lutron - HI-LUME PREMIER 0,1% Eco System 24V/96W</p> <p><b>I</b> - Casambi CBU-A2D-0/10V-DALI-Bluetooth 100/277 VAC</p> <p><b>J</b> - Casambi CBU-PWM4-4CH-Bluetooth 100/277 VAC</p> <p><b>K</b> - Casambi CBU-TED-CV-Trail edge dim-Bluetooth 120 VAC</p> <p><b>NO</b> - No driver</p>	<p>* The light output is provided in lumens per foot, for a CCT of 4200K and a clear lens. Please refer to the optics page for CCT and translucency conversion factors.</p> <p>** By default both Up &amp; Down LED engines are controlled from one source. For custom options, please contact your local representative.</p> <p>*** Only available in 96W - 24V Driver</p> <div style="border: 1px solid black; padding: 5px; text-align: center;"> <p>TITLE</p> <p><b>24</b></p> <p>CONVERSION</p> </div>
CCT DOWN    CCT UP	LM DOWN    LM UP	<b>I</b>	POWER SUPPLY/CONTROL	

# TAO

Wood Series



## Cross-section dimensions:

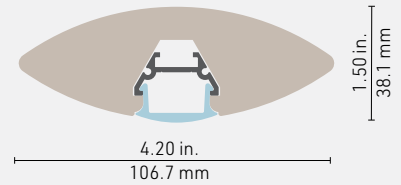

The **TAO** will hover seemingly **weightless in space**, with its organic blend of **futuristic form** and **timeless appeal** of wood. With a discreet visual signature from afar, it will unravel its texture in full from a more personal distance, all while casting light of a desired quality (and quantity).

## FEATURES

- Engineered from sustainably harvested and recycled hardwood, for superior mechanical quality and to bring out the natural wood texture.
- Designed to give a uniform light without hot spots with an optiflex, opal or prime lens.
- Custom length by sections of 2 to 144 inches (3.6m).
- Application guide for 10mm (3/8-inch) LED engine or less.
- The insert is made of ALCOA 6063-T5 aluminum alloy increasing heat dissipation.
- Available in oiled finish, or in custom wood essences and tints.

## OPTIONS













## LED ENGINE COMPATIBILITY

Compatible with LED engines or PCBs up to **14mm** wide.

## LINEAR WEIGHT

1.024 lbs/ft, 1.524 kg/m (without lens or insert)



PROFILE	LENSES	MOUNTING HARDWARE	CANOPY	LENGTH
 <p><b>TA00</b> - Wood enclosure, Oiled finish Alu heatsink included with profile</p>	 <p><b>CL</b> - Clear lens</p>  <p><b>OX</b> - Optiflex lens</p>  <p><b>OP</b> - Opal lens</p>  <p><b>PR</b> - Prime lens</p>  <p><b>NO</b> - No Lens</p>	 <p><b>SUS</b> - Suspension kit with 15ft. aircraft cable</p>	 <p><b>Remote driver canopy plate</b> See Appendix 2 on page 158 <b>CR0</b> - Alu <b>CR1</b> - Black <b>CR2</b> - White</p>  <p><b>Integrated driver in canopy</b> See Appendix 2 on page 158 <b>CI0</b> - Alu <b>CI1</b> - Black <b>CI2</b> - White</p>  <p><b>Integrated driver &amp; suspension kit</b> See Appendix 2 on page 158 <b>CIK0</b> - Alu <b>CIK1</b> - Black <b>CIK2</b> - White</p>  <p><b>NO</b> - No canopy</p>	<p>Custom length by sections of 12 to 144 inches (3.6m), in increments of 12 inches (30cm).</p> <p>By default suspension will be installed 6 inches (15.3cm) from the ends of the profile. For custom options please contact your local representative.</p>
<b>TA00</b>			<b>SUS</b>	
PROFILE	LENS	BRACKETS	MOUNTING HARDWARE	LENGTH

COLOR TEMPERATURE	LM PACKAGE DOWN/UP*	USAGE	POWERSUPPLY/CONTROL**	*NOTES
<p><b>24</b> - 2400K</p> <p><b>27</b> - 2700K</p> <p><b>30</b> - 3000K</p> <p><b>35</b> - 3500K</p> <p><b>42</b> - 4200K</p> <p><b>53</b> - 5300K (LHP only)</p> <p><b>62</b> - 6200K (LP only)</p> <p><b>WD1</b> - WarmDim 14W</p> <p><b>WD2</b> - WarmDim 17W</p> <p><b>TW1</b> - Tunable White 11W</p> <p><b>TW2</b> - Tunable White 19W</p> <p><b>RGB1</b> - RGB 14W</p> <p><b>RGB2</b> - RGB 19W</p> <p><b>RGBW1</b> - 3000K</p> <p><b>RGBW2</b> - 3000K 4in1</p> <p><b>NO</b> - No up light (w/ opal lens)</p>	<p><b>LP0</b> - 128 LM / 1.5W FT / 90+CRI</p> <p><b>LP1</b> - 160 LM / 1.5W FT / 90+CRI</p> <p><b>LP2</b> - 255 LM / 3.0W FT / 90+CRI</p> <p><b>LP3</b> - 308 LM / 4.5W FT / 90+CRI</p> <p><b>LP4</b> - 400 LM / 5.8W FT / 90+CRI</p> <p><b>LHP</b> - 700 LM / 7.0W FT / 95+CRI</p> <p><b>Note:</b> Not applicable for Warmdim, Tunable White &amp; RGB color temperatures</p>	<p><b>I</b> - IP22 indoor dry location</p>	<p><b>A</b> - Non-dimming</p> <p><b>B</b> - ELV dimming 120V AC</p> <p><b>C</b> - ELV dimming 120/277 VAC***</p> <p><b>D</b> - 0/10V dimming 120/277 VAC</p> <p><b>E</b> - Non-dimming DC plug in</p> <p><b>F</b> - DMX</p> <p><b>G</b> - Lutron - HI-LUME PREMIER 0,1% Eco System 24V/96W</p> <p><b>I</b> - Casambi CBU-A2D-0/10V-DALI-Bluetooth 100/277 VAC</p> <p><b>J</b> - Casambi CBU-PWM4-4CH-Bluetooth 100/277 VAC</p> <p><b>K</b> - Casambi CBU-TED-CV-Trail edge dim-Bluetooth 120 VAC</p> <p><b>NO</b> - No driver</p>	<p>* The light output is provided in lumens per foot, for a CCT of 4200K and a clear lens. Please refer to the optics page for CCT and translucency conversion factors.</p> <p>** By default both Up &amp; Down LED engines are controlled from one source. For custom options, please contact your local representative.</p> <p>*** Only available in 96W - 24V Driver</p>
CCT DOWN	CCT UP	LM DOWN	LM UP	USAGE
			<b>I</b>	POWER SUPPLY/CONTROL

# SILO

Wood Series



## Cross-section dimensions:

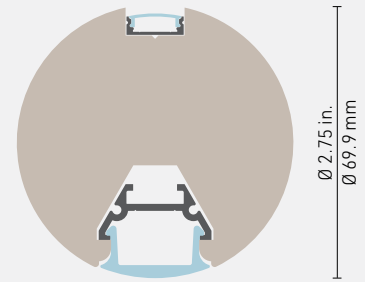

The **SILO** is another **minimalist profile** that is under 3 inches in diameter but brings all the **warmth and texture** that distinguishes our Wood Series. Its lightweight elegance is a welcome touch to contemporary spaces.

## FEATURES

- Engineered from sustainably harvested and recycled hardwood, for superior mechanical quality and to bring out the natural wood texture.
- Designed to give a uniform light without hot spots with an optiflex, opal or prime lens.
- Custom length by sections of 2 to 144 inches (3.6m).
- Application guide for 10mm (3/8-inch) LED engine or less.
- The insert is made of ALCOA 6063-T5 aluminum alloy increasing heat dissipation.
- Available in oiled finish, or in custom wood essences and tints.

## OPTIONS

















## LED ENGINE COMPATIBILITY

Compatible with LED engines or PCBs up to **14mm** wide.

## LINEAR WEIGHT

1.419 lbs/ft, 2.112 kg/m (without lens or insert)



PROFILE	LENS DOWN	LENS UP	MOUNTING HARDWARE	CANOPY	LENGTH
 <p><b>SIL0</b> - Wood enclosure, Oiled finish Alu heatsink included with profile</p>	 <p><b>CL</b> - Clear lens</p>  <p><b>OX</b> - Optiflex lens</p>  <p><b>OP</b> - Opal lens</p>  <p><b>PR</b> - Prime lens</p> <p><b>NO</b> - No Lens</p>	 <p><b>CL</b> - Clear lens</p>  <p><b>SP</b> - Spread lens</p>  <p><b>OX</b> - Optiflex lens</p>  <p><b>OP</b> - Opal lens</p>  <p><b>PR</b> - Prime lens</p> <p><b>NO</b> - No lens</p>	 <p><b>SUS</b> - Suspension kit with 15ft. aircraft cable</p>	 <p><b>Remote driver canopy plate</b> See Appendix 2 on page 158 <b>CR0</b> - Alu <b>CR1</b> - Black <b>CR2</b> - White</p>  <p><b>Integrated driver in canopy</b> See Appendix 2 on page 158 <b>CI0</b> - Alu <b>CI1</b> - Black <b>CI2</b> - White</p>  <p><b>Integrated driver &amp; suspension kit</b> See Appendix 2 on page 158 <b>CIK0</b> - Alu <b>CIK1</b> - Black <b>CIK2</b> - White</p> <p><b>NO</b> - No canopy</p>	<p>Custom length by sections of 12 to 144 inches (3.6m), in increments of 12 inches (30cm).</p> <p>By default suspension will be installed 6 inches (15.3cm) from the ends of the profile. For custom options please contact your local representative.</p>
<b>SIL0</b>			<b>SUS</b>		
PROFILE	LENS DOWN	LENS UP	MOUNTING HARDWARE	CANOPY	LENGTH

COLOR TEMPERATURE	LM PACKAGE DOWN/UP*	USAGE	POWERSUPPLY/CONTROL**	*NOTES
<p><b>24</b> - 2400K</p> <p><b>27</b> - 2700K</p> <p><b>30</b> - 3000K</p> <p><b>35</b> - 3500K</p> <p><b>42</b> - 4200K</p> <p><b>53</b> - 5300K (LHP only)</p> <p><b>62</b> - 6200K (LP only)</p> <p><b>WD1</b> - WarmDim 14W</p> <p><b>WD2</b> - WarmDim 17W</p> <p><b>TW1</b> - Tunable White 11W</p> <p><b>TW2</b> - Tunable White 19W</p> <p><b>RGB1</b> - RGB 14W</p> <p><b>RGB2</b> - RGB 19W</p> <p><b>RGBW1</b> - 3000K</p> <p><b>RGBW2</b> - 3000K 4in1</p> <p><b>NO</b> - No up light (w/ opal lens)</p>	<p><b>LP0</b> - 128 LM / 1.5W FT / 90+CRI</p> <p><b>LP1</b> - 160 LM / 1.5W FT / 90+CRI</p> <p><b>LP2</b> - 255 LM / 3.0W FT / 90+CRI</p> <p><b>LP3</b> - 308 LM / 4.5W FT / 90+CRI</p> <p><b>LP4</b> - 400 LM / 5.8W FT / 90+CRI</p> <p><b>LHP</b> - 700 LM / 7.0W FT / 95+CRI</p> <p><b>Note:</b> Not applicable for Warmdim, Tunable White &amp; RGB color temperatures</p>	<p><b>I</b> - IP22 indoor dry location</p>	<p><b>A</b> - Non-dimming</p> <p><b>B</b> - ELV dimming 120V AC</p> <p><b>C</b> - ELV dimming 120/277 VAC***</p> <p><b>D</b> - 0/10V dimming 120/277 VAC</p> <p><b>E</b> - Non-dimming DC plug in</p> <p><b>F</b> - DMX</p> <p><b>G</b> - Lutron - HI-LUME PREMIER 0,1% Eco System 24V/96W</p> <p><b>I</b> - Casambi CBU-A2D-0/10V-DALI-Bluetooth 100/277 VAC</p> <p><b>J</b> - Casambi CBU-PWM4-4CH-Bluetooth 100/277 VAC</p> <p><b>K</b> - Casambi CBU-TED-CV-Trail edge dim-Bluetooth 120 VAC</p> <p><b>NO</b> - No driver</p>	<p>* The light output is provided in lumens per foot, for a CCT of 4200K and a clear lens. Please refer to the optics page for CCT and translucency conversion factors.</p> <p>** By default both Up &amp; Down LED engines are controlled from one source. For custom options, please contact your local representative.</p> <p>*** Only available in 96W - 24V Driver</p>
<b>I</b>				
CCT DOWN    CCT UP	LM DOWN    LM UP	USAGE	POWERSUPPLY/CONTROL	

# PIKE

Wood Series



## Cross-section dimensions:

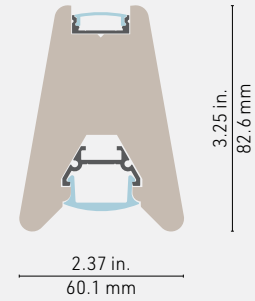

**Go edgy and playful** with a youthful approach on the classic of wood. The **PIKE** is the profile with the **most discreet light source** in the series, for a fresh yet unobtrusive visual presence that is particularly fit for social spaces, whether recreational or collaborative.

## FEATURES

- Engineered from sustainably harvested and recycled hardwood, for superior mechanical quality and to bring out the natural wood texture.
- Designed to give a uniform light without hot spots with an optiflex, opal or prime lens.
- Custom length by sections of 2 to 144 inches (3.6m).
- Application guide for 10mm (3/8-inch) LED engine or less.
- The insert is made of ALCOA 6063-T5 aluminum alloy increasing heat dissipation.
- Available in oiled finish, or in custom wood essences and tints.

## OPTIONS



## LED ENGINE COMPATIBILITY















Compatible with LED engines or PCBs up to **14mm** wide.

## LINEAR WEIGHT

1.275 lbs/ft, 1.898 kg/m (without lens or insert)





PROFILE	LENS DOWN	LENS UP	MOUNTING HARDWARE	CANOPY	LENGTH
 <p><b>PIKO</b> - Wood enclosure, Oiled finish Alu heatsink included with profile</p>	 <p><b>CL</b> - Clear lens</p>  <p><b>OX</b> - Optiflex lens</p>  <p><b>OP</b> - Opal lens</p>  <p><b>PR</b> - Prime lens</p> <p><b>NO</b> - No Lens</p>	 <p><b>CL</b> - Clear lens</p>  <p><b>SP</b> - Spread lens</p>  <p><b>OX</b> - Optiflex lens</p>  <p><b>OP</b> - Opal lens</p>  <p><b>PR</b> - Prime lens</p> <p><b>NO</b> - No lens</p>	 <p><b>SUS</b> - Suspension kit with 15ft. aircraft cable</p>	 <p><b>Remote driver canopy plate</b> See Appendix 2 on page 158 <b>CR0</b> - Alu <b>CR1</b> - Black <b>CR2</b> - White</p>  <p><b>Integrated driver in canopy</b> See Appendix 2 on page 158 <b>CI0</b> - Alu <b>CI1</b> - Black <b>CI2</b> - White</p>  <p><b>Integrated driver &amp; suspension kit</b> See Appendix 2 on page 158 <b>CIK0</b> - Alu <b>CIK1</b> - Black <b>CIK2</b> - White</p> <p><b>NO</b> - No canopy</p>	<p>Custom length by sections of 12 to 144 inches (3.6m), in increments of 12 inches (30cm).</p> <p>By default suspension will be installed 6 inches (15.3cm) from the ends of the profile. For custom options please contact your local representative.</p>
<b>PIKO</b>			<b>SUS</b>		
PROFILE	LENS DOWN	LENS UP	MOUNTING HARDWARE	CANOPY	LENGTH

COLOR TEMPERATURE	LM PACKAGE DOWN/UP*	USAGE	POWERSUPPLY/CONTROL**	*NOTES
<p><b>24</b> - 2400K</p> <p><b>27</b> - 2700K</p> <p><b>30</b> - 3000K</p> <p><b>35</b> - 3500K</p> <p><b>42</b> - 4200K</p> <p><b>53</b> - 5300K (LHP only)</p> <p><b>62</b> - 6200K (LP only)</p> <p><b>WD1</b> - WarmDim 14W</p> <p><b>WD2</b> - WarmDim 17W</p> <p><b>TW1</b> - Tunable White 11W</p> <p><b>TW2</b> - Tunable White 19W</p> <p><b>RGB1</b> - RGB 14W</p> <p><b>RGB2</b> - RGB 19W</p> <p><b>RGBW1</b> - 3000K</p> <p><b>RGBW2</b> - 3000K 4in1</p> <p><b>NO</b> - No up light (w/ opal lens)</p>	<p><b>LP0</b> - 128 LM / 1.5W FT / 90+CRI</p> <p><b>LP1</b> - 160 LM / 1.5W FT / 90+CRI</p> <p><b>LP2</b> - 255 LM / 3.0W FT / 90+CRI</p> <p><b>LP3</b> - 308 LM / 4.5W FT / 90+CRI</p> <p><b>LP4</b> - 400 LM / 5.8W FT / 90+CRI</p> <p><b>LHP</b> - 700 LM / 7.0W FT / 95+CRI</p> <p><b>Note:</b> Not applicable for Warmdim, Tunable White &amp; RGB color temperatures</p>	<p><b>I</b> - IP22 indoor dry location</p>	<p><b>A</b> - Non-dimming</p> <p><b>B</b> - ELV dimming 120V AC</p> <p><b>C</b> - ELV dimming 120/277 VAC***</p> <p><b>D</b> - 0/10V dimming 120/277 VAC</p> <p><b>E</b> - Non-dimming DC plug in</p> <p><b>F</b> - DMX</p> <p><b>G</b> - Lutron - HI-LUME PREMIER 0,1% Eco System 24V/96W</p> <p><b>I</b> - Casambi CBU-A2D-0/10V-DALI-Bluetooth 100/277 VAC</p> <p><b>J</b> - Casambi CBU-PWM4-4CH-Bluetooth 100/277 VAC</p> <p><b>K</b> - Casambi CBU-TED-CV-Trail edge dim-Bluetooth 120 VAC</p> <p><b>NO</b> - No driver</p>	<p>* The light output is provided in lumens per foot, for a CCT of 4200K and a clear lens. Please refer to the optics page for CCT and translucency conversion factors.</p> <p>** By default both Up &amp; Down LED engines are controlled from one source. For custom options, please contact your local representative.</p> <p>*** Only available in 96W - 24V Driver</p> <div style="border: 1px solid black; padding: 2px; display: inline-block;"> <p>TITLE <b>24</b> CONVERSION</p> </div>
CCT DOWN    CCT UP	LM DOWN    LM UP	<b>I</b>	POWER SUPPLY/CONTROL	



**G Y P S U M   S E R I E S**





# AP SIS

Gypsum Series



## Cross-section dimensions:

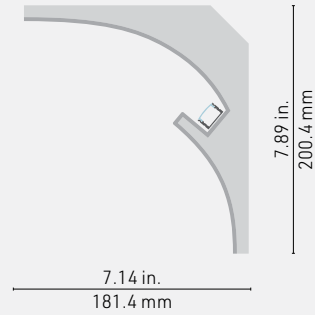

Smooth out those corners with a **rounded light extravaganza!** The APSIS will go into any corner, whether wall or ceiling, and level out flush with the 1/2" gypsum panels. Prime and paint, mount the aluminum LED profile with your choice of lens, and breathe a brand new life into your interior. As easy as it gets!

## FEATURES

- Shape made of architectural-grade extruded polystyrene foam for stiffness and a high R-factor, exterior surface reinforced with fiberglass for rigidity, finished in white plaster that is primable and paintable like a regular gypsum panel.
- Flush installation with standard 1/2in. gypsum panels, or level with drywall mud to match seamlessly with 5/8in. panels.
- Direct fit for the 1100 and 1200 profiles in ALCOA 6063-T5 aluminum alloy for superior heat dissipation, allowing the use of the full range of 1000 Series lenses, for full control of the lighting effect.
- Designed to give a uniform light without hot spots with series 1200, an opal lens and an LED engine of 120 LEDs per meter or more.
- Application guide for 10mm (3/8-inch) LED engine or less.
- Available only in sections of 8 feet (2.4m). Customer is responsible for cutting.



Fire Rated Material Type : **NFPA CLASS C**  
(tested under ASTM E84. Similar to UL723, ANSI/NFPA No. 255 and UBC No. 8-1)

## OPTIONS



## LED ENGINE COMPATIBILITY

Compatible with LED engines up to **14mm** wide.







## LINEAR WEIGHT

0.848 lbs/ft, 1.262 kg/m (without aluminum profile or lens)

















GYPSUM PROFILE	LENGTH
 <p>APS - Gypsum profile * Light source delivered separately from the Gypsum fixture.</p>	Available in straight section of 8 feet (96 inches/2.4 m).
QUANTITY	<div style="border: 1px solid black; padding: 5px; display: inline-block;"> <b>96 INCHES</b> </div>

**Suggested aluminum profile options (for more information see product pages pp.10-13)**

ALU PROFILE	LENSES	MOUNTING HARDWARE	LENGTH
 <p>1100 - Profile, Alu</p>	 <p>OX - Optiflex lens</p>	 <p>3M - 3M mounting tape, 8mm</p>	Custom length by sections of 2 to 240 inches (6m).
 <p>1200 - 1200 Profile, alu</p>	 <p>OP - Opal lens</p>	 <p>NO - No mounting hardware</p>	
ALU PROFILE	LENSES	MOUNTING HARDWARE	LENGTH

**LED engine will be assembled on site. See Appendix 3 on page 159 to see how to calculate total ordering length.**

COLOR TEMPERATURE	LUMEN PACKAGE*	LEAD IN / OUT	USAGE	POWER SUPPLY / CONTROL	LENGTH
<ul style="list-style-type: none"> <li> 24 - 2400K</li> <li> 27 - 2700K</li> <li> 30 - 3000K</li> <li> 35 - 3500K</li> <li> 42 - 4200K</li> <li> 53 - 5300K (LHP only)</li> <li> 62 - 6200K (LP only)</li> <li> WD1 - WarmDim 14W</li> <li> WD2 - WarmDim 17W</li> <li> TW1 - Tunable White 11W</li> <li> TW2 - Tunable White 19W</li> <li> RGB1 - RGB 14W</li> <li> RGB2 - RGB 19W</li> <li> RGBW1 - 3000K</li> <li> RGBW2 - 3000K 4in1</li> </ul>	<p>LP0 - 128 LM / 1.5W FT / 90+CRI</p> <p>LP1 - 160 LM / 1.5W FT / 90+CRI</p> <p>LP2 - 255 LM / 3.0W FT / 90+CRI</p> <p>LP3 - 308 LM / 4.5W FT / 90+CRI</p> <p>LP4 - 400 LM / 5.8W FT / 90+CRI</p> <p>LHP - 700 LM / 7.0W FT / 95+CRI</p> <p><b>Note:</b> Not applicable for Warmdim, Tunable White &amp; RGB color temperatures</p>	<p>HW3 - Hardware 3 FT</p> <p>HW6 - Hardware 6 FT</p> <p>HW9 - Hardware 9 FT</p> <p>HWX - Hardware custom FT</p> <p>DC3 - DC plug 3 FT</p> <p>DC6 - DC plug 6 FT</p> <p>DC9 - DC plug 9 FT</p> <p>DCX - DC plug custom FT</p> <p>SUS - Coaxial wire 15 Ft</p> <p>NO - No lead</p>	<p>I - IP22 indoor dry location</p>	<p>A - Non-dimming</p> <p>B - ELV dimming 120V AC</p> <p>C - ELV dimming 120/277 VAC**</p> <p>D - 0/10V dimming 120/277 VAC</p> <p>E - Non-dimming DC plug in</p> <p>F - DMX</p> <p>G - Lutron - HI-LUME PREMIER 0,1% Eco System 24V/96W</p> <p>I - Casambi CBU-A2D-0/10V-DALI-Bluetooth 100/277 VAC</p> <p>J - Casambi CBU-PWM4-4CH-Bluetooth 100/277 VAC</p> <p>K - Casambi CBU-TED-CV-Trail edge dim-Bluetooth 120 VAC</p> <p>NO - No driver</p>	<p><b>Total length of LED engine in inches</b> - See Appendix 3 on how to calculate length.</p>
COLOR TEMPERATURE CCT	LUMEN PACKAGE	LEAD IN      LEAD OUT	USAGE	POWER SUPPLY / CONTROL	LED ENGINE LENGTH

\*NOTE: The light output is provided in lumens per foot, for a CCT of 4200K and a clear lens. Please refer to the optics page for CCT and translucency conversion factors. \*\* Only available in 96W - 24V Driver

# ARCUS

Gypsum Series

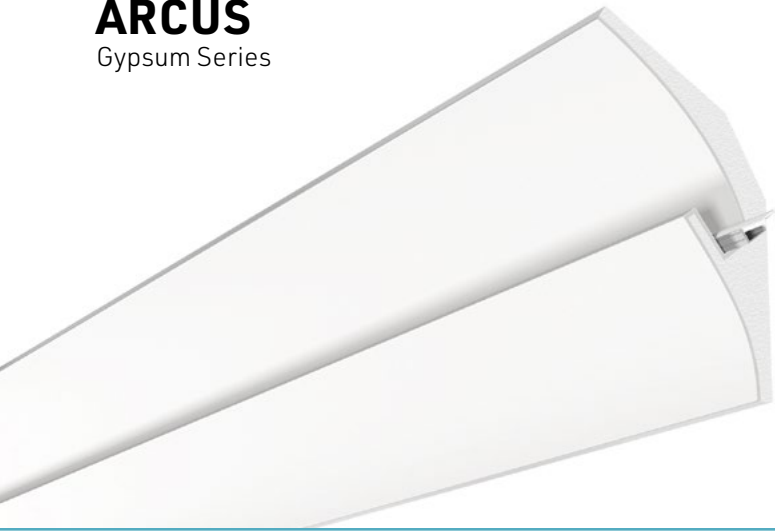

## Cross-section dimensions:

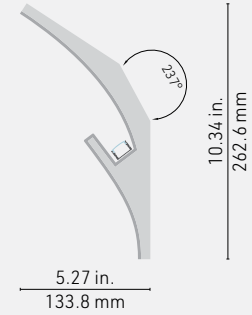

The **ARCUS** moulding is designed for slanted surfaces, such as in **attics or cathedral ceiling rooms**. It levels out flush with 1/2" or 5/8" gypsum panels, and contains a recessed LED channel for smooth lighting of the ceiling perimeter. Fits most common slant angles, with room for adjustment using drywall mud. It can be primed and painted like a regular wall surface.

## FEATURES

- Shape made of architectural-grade extruded polystyrene foam for stiffness and a high R-factor, exterior surface reinforced with fiberglass for rigidity, finished in white plaster that is primable and paintable like a regular gypsum panel.
- Flush installation with standard 1/2in. gypsum panels, or level with drywall mud to match seamlessly with 5/8in. panels.
- Direct fit for the 1100 and 1200 profiles in ALCOA 6063-T5 aluminum alloy for superior heat dissipation, allowing the use of the full range of 1000 Series lenses, for full control of the lighting effect.
- Designed to give a uniform light without hot spots with series 1200, an opal lens and an LED engine of 120 LEDs per meter or more.
- Application guide for 10mm (3/8-inch) LED engine or less.
- Available only in sections of 8 feet (2.4m). Customer is responsible for cutting.



Fire Rated Material Type : **NFPA CLASS C**  
(tested under ASTM E84. Similar to UL723, ANSI/NFPA No. 255 and UBC No. 8-1)

## OPTIONS



## LED ENGINE COMPATIBILITY

Compatible with LED engines up to **14mm** wide.







## LINEAR WEIGHT

0.856 lbs/ft, 1.275 kg/m (without aluminum profile or lens)

















GYPSUM PROFILE	LENGTH
 <p><b>ARC</b> - Gypsum profile * Light source delivered separately from the Gypsum fixture.</p>	Available in straight section of 8 feet (96 inches/2.4 m).
QUANTITY	X <b>96 INCHES</b> LENGTH

**Suggested aluminum profile options (for more information see product pages pp.10-13)**

ALU PROFILE	LENSES	MOUNTING HARDWARE	LENGTH
 <p><b>1100</b> - Profile, Alu</p>	 <p><b>OX</b> - Optiflex lens</p>	 <p><b>3M</b> - 3M mounting tape, 8mm</p>	Custom length by sections of 2 to 240 inches (6m).
 <p><b>1200</b> - 1200 Profile, alu</p>	 <p><b>OP</b> - Opal lens</p>	 <p><b>NO</b> - No mounting hardware</p>	
ALU PROFILE	LENSES	MOUNTING HARDWARE	LENGTH

**LED engine will be assembled on site. See Appendix 3 on page 159 to see how to calculate total ordering length.**

COLOR TEMPERATURE	LUMEN PACKAGE*	LEAD IN / OUT	USAGE	POWER SUPPLY / CONTROL	LENGTH
<ul style="list-style-type: none"> <li> <b>24</b> - 2400K</li> <li> <b>27</b> - 2700K</li> <li> <b>30</b> - 3000K</li> <li> <b>35</b> - 3500K</li> <li> <b>42</b> - 4200K</li> <li> <b>53</b> - 5300K (LHP only)</li> <li> <b>62</b> - 6200K (LP only)</li> <li> <b>WD1</b> - WarmDim 14W</li> <li> <b>WD2</b> - WarmDim 17W</li> <li> <b>TW1</b> - Tunable White 11W</li> <li> <b>TW2</b> - Tunable White 19W</li> <li> <b>RGB1</b> - RGB 14W</li> <li> <b>RGB2</b> - RGB 19W</li> <li> <b>RGBW1</b> - 3000K</li> <li> <b>RGBW2</b> - 3000K 4in1</li> </ul>	<ul style="list-style-type: none"> <li><b>LP0</b> - 128 LM / 1.5W FT / 90+CRI</li> <li><b>LP1</b> - 160 LM / 1.5W FT / 90+CRI</li> <li><b>LP2</b> - 255 LM / 3.0W FT / 90+CRI</li> <li><b>LP3</b> - 308 LM / 4.5W FT / 90+CRI</li> <li><b>LP4</b> - 400 LM / 5.8W FT / 90+CRI</li> <li><b>LHP</b> - 700 LM / 7.0W FT / 95+CRI</li> </ul> <p><b>Note:</b> Not applicable for Warmdim, Tunable White &amp; RGB color temperatures</p>	<ul style="list-style-type: none"> <li><b>HW3</b> - Hardwire 3 FT</li> <li><b>HW6</b> - Hardwire 6 FT</li> <li><b>HW9</b> - Hardwire 9 FT</li> <li><b>HWX</b> - Hardwire custom FT</li> <li><b>DC3</b> - DC plug 3 FT</li> <li><b>DC6</b> - DC plug 6 FT</li> <li><b>DC9</b> - DC plug 9 FT</li> <li><b>DCX</b> - DC plug custom FT</li> <li><b>SUS</b> - Coaxial wire 15 Ft</li> <li><b>NO</b> - No lead</li> </ul>	<ul style="list-style-type: none"> <li><b>I</b> - IP22 indoor dry location</li> </ul>	<ul style="list-style-type: none"> <li><b>A</b> - Non-dimming</li> <li><b>B</b> - ELV dimming 120V AC</li> <li><b>C</b> - ELV dimming 120/277 VAC**</li> <li><b>D</b> - 0/10V dimming 120/277 VAC</li> <li><b>E</b> - Non-dimming DC plug in</li> <li><b>F</b> - DMX</li> <li><b>G</b> - Lutron - HI-LUME PREMIER 0,1% Eco System 24V/96W</li> <li><b>I</b> - Casambi CBU-A2D-0/10V-DALI-Bluetooth 100/277 VAC</li> <li><b>J</b> - Casambi CBU-PWM4-4CH-Bluetooth 100/277 VAC</li> <li><b>K</b> - Casambi CBU-TED-CV-Trail edge dim-Bluetooth 120 VAC</li> <li><b>NO</b> - No driver</li> </ul>	<p><b>Total length of LED engine in inches</b> - See Appendix 3 on how to calculate length.</p>
COLOR TEMPERATURE CCT	LUMEN PACKAGE	LEAD IN    LEAD OUT	USAGE	POWER SUPPLY / CONTROL	LED ENGINE LENGTH

\*NOTE: The light output is provided in lumens per foot, for a CCT of 4200K and a clear lens. Please refer to the optics page for CCT and translucency conversion factors. \*\* Only available in 96W - 24V Driver

# GEMINUS

Gypsum Series

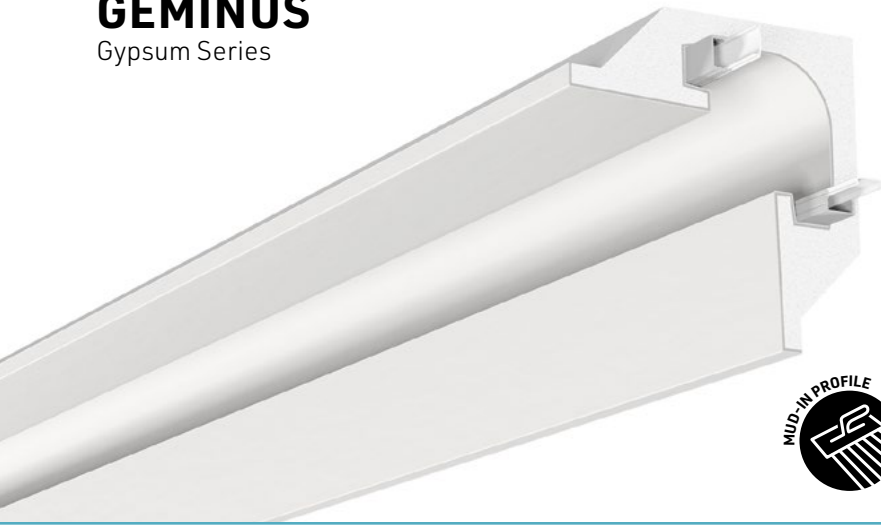

## Cross-section dimensions:

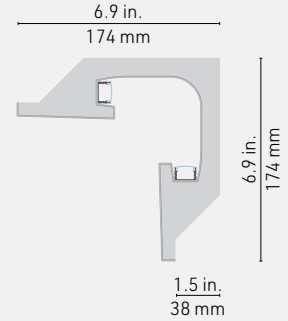

GEMINUS creates **corner alcoves** with a 2-inch wide opening, uniformly lit from both sides, for a **more emphasized linear lighting** effect. A direct fit for 1/2-inch gypsum panels, it can also be leveled with 5/8-inch ones, with the same ease of installation and effectiveness as with other Gypsum Series profiles.

## FEATURES

- Shape made of architectural-grade extruded polystyrene foam for stiffness and a high R-factor, exterior surface reinforced with fiberglass for rigidity, finished in white plaster that is primable and paintable like a regular gypsum panel.
- Flush installation with standard 1/2in. gypsum panels, or level out to 5/8in. panels with drywall mud and tape, while supporting the edges over 2x1.5in. wall/ceiling beams.
- Direct fit for the 1100 and 1200 profiles in ALCOA 6063-T5 aluminum alloy for superior heat dissipation, allowing the use of the full range of 1000 Series lenses, for full control of the lighting effect.
- Designed to give a uniform light without hot spots with series 1200, an opal lens and an LED engine of 120 LEDs per meter or more.
- Application guide for 10mm (3/8-inch) LED engine or less.
- Available only in sections of 8 feet (2.4m). Customer is responsible for cutting.



Fire Rated Material Type : **NFPA CLASS C**

(tested under ASTM E84. Similar to UL723, ANSI/NFPA No. 255 and UBC No. 8-1)

## OPTIONS



## LED ENGINE COMPATIBILITY

Compatible with LED engines up to **14mm** wide.

## LINEAR WEIGHT











1.067 lbs/ft, 1.587 kg/m (without aluminum profile or lens)

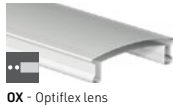
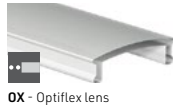

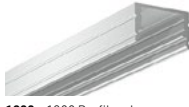
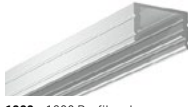



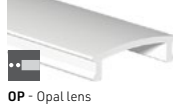











GYPSUM PROFILE	LENGTH
 <p><b>GEM</b> - Gypsum profile * Light source delivered separately from the Gypsum fixture.</p>	Available in straight section of 8 feet (96 inches/2.4 m).
QUANTITY	LENGTH
x	<b>96 INCHES</b>

**Suggested aluminum profile options (for more information see product pages pp.10-13)**

ALU PROFILE	2ND ALU PROFILE	LENSES	2ND LENSES	MOUNTING HARDWARE	LENGTH
 <p>1100 - Profile, Alu</p>	 <p>1100 - Profile, Alu</p>	 <p>OX - Optiflex lens</p>	 <p>OX - Optiflex lens</p>	 <p>3M - 3M mounting tape, 8mm</p>	Custom length by sections of 2 to 240 inches (6m).
 <p>1200 - 1200 Profile, alu</p>	 <p>1200 - 1200 Profile, alu</p> <p> NO - No 2nd profile</p>	 <p>OP - Opal lens</p> <p> NO - No Lens</p>	 <p>OP - Opal lens</p> <p> NO - No Lens</p>	 NO - No mounting hardware	
ALU PROFILE	LENSES	MOUNTING HARDWARE	LENGTH		

**LED engine will be assembled on site. See Appendix 3 on page 159 to see how to calculate total ordering length.**

COLOR TEMPERATURE	LUMEN PACKAGE*	LEAD IN / OUT	USAGE	POWER SUPPLY / CONTROL	LENGTH	
<ul style="list-style-type: none"> <li> 24 - 2400K</li> <li> 27 - 2700K</li> <li> 30 - 3000K</li> <li> 35 - 3500K</li> <li> 42 - 4200K</li> <li> 53 - 5300K (LHP only)</li> <li> 62 - 6200K (LP only)</li> <li> WD1 - WarmDim 14W</li> <li> WD2 - WarmDim 17W</li> <li> TW1 - Tunable White 11W</li> <li> TW2 - Tunable White 19W</li> <li> RGB1 - RGB 14W</li> <li> RGB2 - RGB 19W</li> <li> RGBW1 - 3000K</li> <li> RGBW2 - 3000K 4in1</li> </ul>	<p>LP0 - 128 LM / 1.5W FT / 90+CRI</p> <p>LP1 - 160 LM / 1.5W FT / 90+CRI</p> <p>LP2 - 255 LM / 3.0W FT / 90+CRI</p> <p>LP3 - 308 LM / 4.5W FT / 90+CRI</p> <p>LP4 - 400 LM / 5.8W FT / 90+CRI</p> <p>LHP - 700 LM / 7.0W FT / 95+CRI</p> <p><b>Note:</b> Not applicable for Warmdim, Tunable White &amp; RGB color temperatures</p>	<p>HW3 - Hardwire 3 FT</p> <p>HW6 - Hardwire 6 FT</p> <p>HW9 - Hardwire 9 FT</p> <p>HWX - Hardwire custom FT</p> <p>DC3 - DC plug 3 FT</p> <p>DC6 - DC plug 6 FT</p> <p>DC9 - DC plug 9 FT</p> <p>DCX - DC plug custom FT</p> <p>SUS - Coaxial wire 15 Ft</p> <p>NO - No lead</p>	<p>I - IP22 indoor dry location</p>	<p>A - Non-dimming</p> <p>B - ELV dimming 120V AC</p> <p>C - ELV dimming 120/277 VAC**</p> <p>D - 0/10V dimming 120/277 VAC</p> <p>E - Non-dimming DC plug in</p> <p>F - DMX</p> <p>G - Lutron - HI-LUME PREMIER 0,1% Eco System 24V/96W</p> <p>I - Casambi CBU-A2D-0/10V-DALI-Bluetooth 100/277 VAC</p> <p>J - Casambi CBU-PWM4-4CH-Bluetooth 100/277 VAC</p> <p>K - Casambi CBU-TED-CV-Trail edge dim-Bluetooth 120 VAC</p> <p>NO - No driver</p>	<p><b>Total length of LED engine in inches</b> - See Appendix 3 on how to calculate length.</p>	
COLOR TEMPERATURE CCT	LUMEN PACKAGE	LEAD IN	LEAD OUT	USAGE	POWER SUPPLY / CONTROL	LED ENGINE LENGTH

\*NOTE: The light output is provided in lumens per foot, for a CCT of 4200K and a clear lens. Please refer to the optics page for CCT and translucency conversion factors. \*\* Only available in 96W - 24V Driver

# NIDUS

Gypsum Series



## Cross-section dimensions:

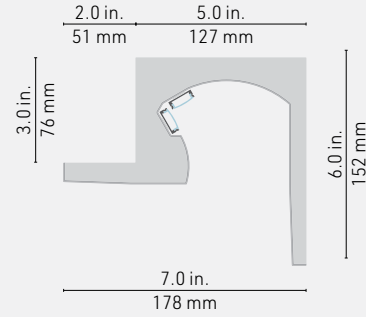

The **NIDUS** profile is an easy and affordable solution for lightgrazing a wall, while keeping the **LED source concealed** and the **corner visually intact**. Install over 2×3in. beams/joists, without the need to build elaborate wood structures, level with the gypsum panels, then mount the LED profile(s) at the position yielding the desired beam direction. Great above blinds or curtains!

## FEATURES

- Shape made of architectural-grade extruded polystyrene foam for stiffness and a high R-factor, exterior surface reinforced with fiberglass for rigidity, finished in white plaster that is primable and paintable like a regular gypsum panel.
- Flush installation with standard 1/2in. gypsum panels, or level out to 5/8in. panels with drywall mud and tape, while supporting the edges over 2x3in. wall/ceiling beams.
- Direct fit for the 1100 and 1200 profiles in ALCOA 6063-T5 aluminum alloy for superior heat dissipation, allowing the use of the full range of 1000 Series lenses, for full control of the lighting effect. The profiles can be installed at one or both of the two available positions.
- Designed to give a uniform light without hot spots with series 1200, an opal lens and an LED engine of 120 LEDs per meter or more.
- Application guide for 10mm (3/8-inch) LED engine or less.
- Available only in sections of 8 feet (2.4m). Customer is responsible for cutting.



Fire Rated Material Type : **NFPA CLASS C**  
(tested under ASTM E84. Similar to UL723, ANSI/NFPA No. 255 and UBC No. 8-1)

## OPTIONS



## LED ENGINE COMPATIBILITY

Compatible with LED engines up to **14mm** wide.







## LINEAR WEIGHT

1.368 lbs/ft, 2.036 kg/m (without aluminum profile or lens)

















GYPSUM PROFILE	LENGTH
 <p><b>NID</b> - Gypsum profile * Light source delivered separately from the Gypsum fixture.</p>	Available in straight section of 8 feet (96 inches/2.4 m).
QUANTITY	<div style="border: 1px solid black; padding: 5px; display: inline-block;"> <b>96 INCHES</b> </div>

### Suggested aluminum profile options (for more information see product pages pp.10-13)

ALU PROFILE	LENSES	MOUNTING HARDWARE	LENGTH
 <p><b>1100</b> - Profile, Alu</p>	 <p><b>OX</b> - Optiflex lens</p>  <p><b>OP</b> - Opal lens</p>  <p><b>NO</b> - No Lens</p>	 <p><b>3M</b> - 3M mounting tape, 8mm</p>  <p><b>NO</b> - No mounting hardware</p>	Custom length by sections of 2 to 240 inches (6m).
 <p><b>1200</b> - 1200 Profile, alu</p>			
ALU PROFILE	LENSES	MOUNTING HARDWARE	LENGTH

### LED engine will be assembled on site. See Appendix 3 on page 159 to see how to calculate total ordering length.

COLOR TEMPERATURE	LUMEN PACKAGE*	LEAD IN / OUT	USAGE	POWER SUPPLY / CONTROL	LENGTH
<ul style="list-style-type: none"> <li> <b>24</b> - 2400K</li> <li> <b>27</b> - 2700K</li> <li> <b>30</b> - 3000K</li> <li> <b>35</b> - 3500K</li> <li> <b>42</b> - 4200K</li> <li> <b>53</b> - 5300K (LHP only)</li> <li> <b>62</b> - 6200K (LP only)</li> <li> <b>WD1</b> - WarmDim 14W</li> <li> <b>WD2</b> - WarmDim 17W</li> <li> <b>TW1</b> - Tunable White 11W</li> <li> <b>TW2</b> - Tunable White 19W</li> <li> <b>RGB1</b> - RGB 14W</li> <li> <b>RGB2</b> - RGB 19W</li> <li> <b>RGBW1</b> - 3000K</li> <li> <b>RGBW2</b> - 3000K 4in1</li> </ul>	<ul style="list-style-type: none"> <li><b>LP0</b> - 128 LM / 1.5W FT / 90+CRI</li> <li><b>LP1</b> - 160 LM / 1.5W FT / 90+CRI</li> <li><b>LP2</b> - 255 LM / 3.0W FT / 90+CRI</li> <li><b>LP3</b> - 308 LM / 4.5W FT / 90+CRI</li> <li><b>LP4</b> - 400 LM / 5.8W FT / 90+CRI</li> <li><b>LHP</b> - 700 LM / 7.0W FT / 95+CRI</li> </ul> <p><b>Note:</b> Not applicable for Warmdim, Tunable White &amp; RGB color temperatures</p>	<ul style="list-style-type: none"> <li><b>HW3</b> - Hardware 3 FT</li> <li><b>HW6</b> - Hardware 6 FT</li> <li><b>HW9</b> - Hardware 9 FT</li> <li><b>HWX</b> - Hardware custom FT</li> <li><b>DC3</b> - DC plug 3 FT</li> <li><b>DC6</b> - DC plug 6 FT</li> <li><b>DC9</b> - DC plug 9 FT</li> <li><b>DCX</b> - DC plug custom FT</li> <li><b>SUS</b> - Coaxial wire 15 Ft</li> <li><b>NO</b> - No lead</li> </ul>	<ul style="list-style-type: none"> <li><b>I</b> - IP22 indoor dry location</li> </ul>	<ul style="list-style-type: none"> <li><b>A</b> - Non-dimming</li> <li><b>B</b> - ELV dimming 120V AC</li> <li><b>C</b> - ELV dimming 120/277 VAC**</li> <li><b>D</b> - 0/10V dimming 120/277 VAC</li> <li><b>E</b> - Non-dimming DC plug in</li> <li><b>F</b> - DMX</li> <li><b>G</b> - Lutron - HI-LUME PREMIER 0,1% Eco System 24V/96W</li> <li><b>I</b> - Casambi CBU-A2D-0/10V-DALI-Bluetooth 100/277 VAC</li> <li><b>J</b> - Casambi CBU-PWM4-4CH-Bluetooth 100/277 VAC</li> <li><b>K</b> - Casambi CBU-TED-CV-Trail edge dim-Bluetooth 120 VAC</li> <li><b>NO</b> - No driver</li> </ul>	<p><b>Total length of LED engine in inches</b> - See Appendix 3 on how to calculate length.</p>
COLOR TEMPERATURE CCT	LUMEN PACKAGE	LEAD IN      LEAD OUT	USAGE	POWER SUPPLY / CONTROL	LED ENGINE LENGTH

\*NOTE: The light output is provided in lumens per foot, for a CCT of 4200K and a clear lens. Please refer to the optics page for CCT and translucency conversion factors. \*\* Only available in 96W - 24V Driver

# SULCUS

Gypsum Series



## Cross-section dimensions:

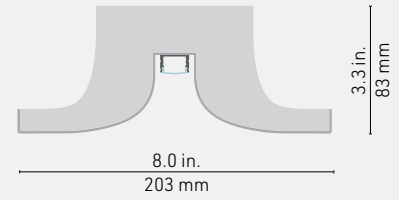

Add **smooth internally lit grooves** to your walls using the SULCUS gypsum profile. It is supported on 2x3in. joists or studs, and will level out flush with 5/8 in. gypsum panels, with a little drywall tape and mud. Paint to match your décor, and enjoy the smooth look as well as the admiration of others!

### FEATURES

- Shape made of architectural-grade extruded polystyrene foam for stiffness and a high R-factor, exterior surface reinforced with fiberglass for rigidity, finished in white plaster that is primable and paintable like a regular gypsum panel.
- Flush installation with standard 5/8in. gypsum panels, over 2x3in. wall/ceiling beams.
- Direct fit for the 1100 and 1200 profiles in ALCOA 6063-T5 aluminum alloy for superior heat dissipation, allowing the use of the full range of 1000 Series lenses, for full control of the lighting effect.
- Designed to give a uniform light without hot spots with series 1200, an opal lens and an LED engine of 120 LEDs per meter or more.
- Application guide for 10mm (3/8-inch) LED engine or less.
- Available only in sections of 8 feet (2.4m). Customer is responsible for cutting.

 Fire Rated Material Type : **NFPA CLASS C**  
(tested under ASTM E84. Similar to UL723, ANSI/NFPA No. 255 and UBC No. 8-1)

### OPTIONS





### LED ENGINE COMPATIBILITY

Compatible with LED engines up to **14mm** wide.



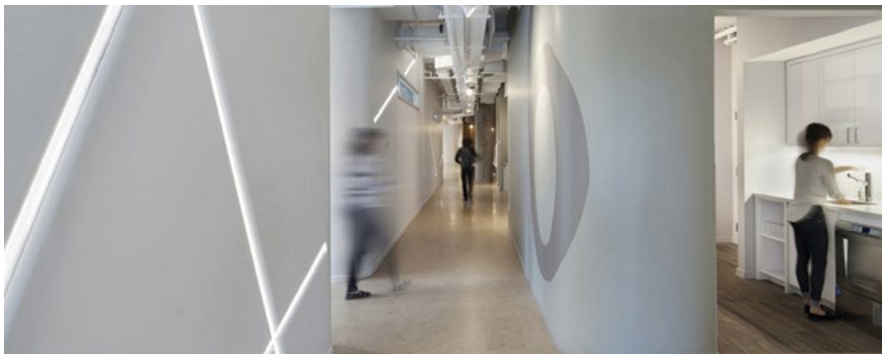



### LINEAR WEIGHT

0.702 lbs/ft, 1.044 kg/m (without aluminum profile or lens)







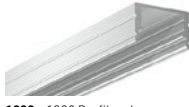









GYPSUM PROFILE	LENGTH
 <p><b>SUL</b> - Gypsum profile * Light source delivered separately from the Gypsum fixture.</p>	Available in straight section of 8 feet (96 inches/2.4 m).
QUANTITY	<div style="border: 1px solid black; padding: 5px; display: inline-block;"> <b>96 INCHES</b> </div>

**Suggested aluminum profile options (for more information see product pages pp.10-13)**

ALU PROFILE	LENSES	MOUNTING HARDWARE	LENGTH
 <p><b>1100</b> - Profile, Alu</p>	 <p><b>OX</b> - Optiflex lens</p>  <p><b>OP</b> - Opal lens</p>  <p><b>NO</b> - No Lens</p>	 <p><b>3M</b> - 3M mounting tape, 8mm</p>  <p><b>NO</b> - No mounting hardware</p>	Custom length by sections of 2 to 240 inches (6m).
 <p><b>1200</b> - 1200 Profile, alu</p>			
ALU PROFILE	LENSES	MOUNTING HARDWARE	LENGTH

**LED engine will be assembled on site. See Appendix 3 on page 159 to see how to calculate total ordering length.**

COLOR TEMPERATURE	LUMEN PACKAGE*	LEAD IN / OUT	USAGE	POWER SUPPLY / CONTROL	LENGTH
<ul style="list-style-type: none"> <li> <b>24</b> - 2400K</li> <li> <b>27</b> - 2700K</li> <li> <b>30</b> - 3000K</li> <li> <b>35</b> - 3500K</li> <li> <b>42</b> - 4200K</li> <li> <b>53</b> - 5300K (LHP only)</li> <li> <b>62</b> - 6200K (LP only)</li> <li> <b>WD1</b> - WarmDim 14W</li> <li> <b>WD2</b> - WarmDim 17W</li> <li> <b>TW1</b> - Tunable White 11W</li> <li> <b>TW2</b> - Tunable White 19W</li> <li> <b>RGB1</b> - RGB 14W</li> <li> <b>RGB2</b> - RGB 19W</li> <li> <b>RGBW1</b> - 3000K</li> <li> <b>RGBW2</b> - 3000K 4in1</li> </ul>	<ul style="list-style-type: none"> <li><b>LP0</b> - 128 LM / 1.5W FT / 90+CRI</li> <li><b>LP1</b> - 160 LM / 1.5W FT / 90+CRI</li> <li><b>LP2</b> - 255 LM / 3.0W FT / 90+CRI</li> <li><b>LP3</b> - 308 LM / 4.5W FT / 90+CRI</li> <li><b>LP4</b> - 400 LM / 5.8W FT / 90+CRI</li> <li><b>LHP</b> - 700 LM / 7.0W FT / 95+CRI</li> </ul> <p><b>Note:</b> Not applicable for Warmdim, Tunable White &amp; RGB color temperatures</p>	<ul style="list-style-type: none"> <li><b>HW3</b> - Hardwire 3 FT</li> <li><b>HW6</b> - Hardwire 6 FT</li> <li><b>HW9</b> - Hardwire 9 FT</li> <li><b>HWX</b> - Hardwire custom FT</li> <li><b>DC3</b> - DC plug 3 FT</li> <li><b>DC6</b> - DC plug 6 FT</li> <li><b>DC9</b> - DC plug 9 FT</li> <li><b>DCX</b> - DC plug custom FT</li> <li><b>SUS</b> - Coaxial wire 15 Ft</li> <li><b>NO</b> - No lead</li> </ul>	<ul style="list-style-type: none"> <li><b>I</b> - IP22 indoor dry location</li> </ul>	<ul style="list-style-type: none"> <li><b>A</b> - Non-dimming</li> <li><b>B</b> - ELV dimming 120V AC</li> <li><b>C</b> - ELV dimming 120/277 VAC**</li> <li><b>D</b> - 0/10V dimming 120/277 VAC</li> <li><b>E</b> - Non-dimming DC plug in</li> <li><b>F</b> - DMX</li> <li><b>G</b> - Lutron - HI-LUME PREMIER 0,1% Eco System 24V/96W</li> <li><b>I</b> - Casambi CBU-A2D-0/10V-DALI-Bluetooth 100/277 VAC</li> <li><b>J</b> - Casambi CBU-PWM4-4CH-Bluetooth 100/277 VAC</li> <li><b>K</b> - Casambi CBU-TED-CV-Trail edge dim-Bluetooth 120 VAC</li> <li><b>NO</b> - No driver</li> </ul>	<p><b>Total length of LED engine in inches</b> - See Appendix 3 on how to calculate length.</p>
COLOR TEMPERATURE CCT	LUMEN PACKAGE	LEAD IN      LEAD OUT	USAGE	POWER SUPPLY / CONTROL	LED ENGINE LENGTH

\*NOTE: The light output is provided in lumens per foot, for a CCT of 4200K and a clear lens. Please refer to the optics page for CCT and translucency conversion factors. \*\* Only available in 96W - 24V Driver

# LATUS

Gypsum Series



## Cross-section dimensions:

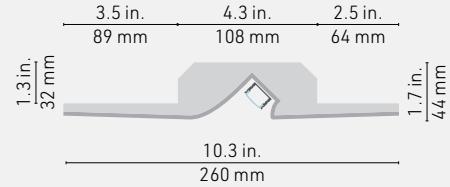

The **LATUS** is an asymmetric recessed LED moulding for drywall, allowing **washing an adjacent surface with light from a 45-degree angle**, from a distance of your choice. The uniform light distribution enhances the appearance of art and displayed items. A direct fit with standard gypsum panels, it needs only a low (1-1/4in.) back clearance, and can be easily installed between smaller beams or joists.

## FEATURES

- Shape made of architectural-grade extruded polystyrene foam for stiffness and a high R-factor, exterior surface reinforced with fiberglass for rigidity, finished in white plaster that is primable and paintable like a regular gypsum panel.
- Flush installation with standard 5/8in. gypsum panels.
- Direct fit for the 1100 and 1200 profiles in ALCOA 6063-T5 aluminum alloy for superior heat dissipation, allowing the use of the full range of 1000 Series lenses, for full control of the lighting effect.
- Designed to give a uniform light without hot spots with series 1200, an opal lens and an LED engine of 120 LEDs per meter or more.
- Application guide for 10mm (3/8-inch) LED engine or less.
- Available only in sections of 8 feet (2.4m). Customer is responsible for cutting.



Fire Rated Material Type : **NFPA CLASS C**  
(tested under ASTM E84. Similar to UL723, ANSI/NFPA No. 255 and UBC No. 8-1)

## OPTIONS



## LED ENGINE COMPATIBILITY

Compatible with LED engines up to **14mm** wide.







## LINEAR WEIGHT

0.637 lbs/ft, 0.947 kg/m (without aluminum profile or lens)

















GYPSUM PROFILE	LENGTH
 <p><b>LAT</b> - Gypsum profile * Light source delivered separately from the Gypsum fixture.</p>	Available in straight section of 8 feet (96 inches/2.4 m).
QUANTITY	<div style="border: 1px solid black; padding: 5px; display: inline-block;"> <b>96 INCHES</b> </div>

Suggested aluminum profile options (for more information see product pages pp.10-13)

ALU PROFILE	LENSES	MOUNTING HARDWARE	LENGTH
 <p><b>1100</b> - Profile, Alu</p>	 <p><b>OX</b> - Optiflex lens</p>	 <p><b>3M</b> - 3M mounting tape, 8mm</p>	Custom length by sections of 2 to 240 inches (6m).
 <p><b>1200</b> - 1200 Profile, alu</p>	 <p><b>OP</b> - Opal lens</p>	 <p><b>NO</b> - No mounting hardware</p>	
ALU PROFILE	LENSES	MOUNTING HARDWARE	LENGTH

LED engine will be assembled on site. See Appendix 3 on page 159 to see how to calculate total ordering length.

COLOR TEMPERATURE	LUMEN PACKAGE*	LEAD IN / OUT	USAGE	POWER SUPPLY / CONTROL	LENGTH
<ul style="list-style-type: none"> <li> <b>24</b> - 2400K</li> <li> <b>27</b> - 2700K</li> <li> <b>30</b> - 3000K</li> <li> <b>35</b> - 3500K</li> <li> <b>42</b> - 4200K</li> <li> <b>53</b> - 5300K (LHP only)</li> <li> <b>62</b> - 6200K (LP only)</li> <li> <b>WD1</b> - WarmDim 14W</li> <li> <b>WD2</b> - WarmDim 17W</li> <li> <b>TW1</b> - Tunable White 11W</li> <li> <b>TW2</b> - Tunable White 19W</li> <li> <b>RGB1</b> - RGB 14W</li> <li> <b>RGB2</b> - RGB 19W</li> <li> <b>RGBW1</b> - 3000K</li> <li> <b>RGBW2</b> - 3000K 4in1</li> </ul>	<p><b>LP0</b> - 128 LM / 1.5W FT / 90+CRI</p> <p><b>LP1</b> - 160 LM / 1.5W FT / 90+CRI</p> <p><b>LP2</b> - 255 LM / 3.0W FT / 90+CRI</p> <p><b>LP3</b> - 308 LM / 4.5W FT / 90+CRI</p> <p><b>LP4</b> - 400 LM / 5.8W FT / 90+CRI</p> <p><b>LHP</b> - 700 LM / 7.0W FT / 95+CRI</p> <p><b>Note:</b> Not applicable for Warmdim, Tunable White &amp; RGB color temperatures</p>	<p><b>HW3</b> - Hardware 3 FT</p> <p><b>HW6</b> - Hardware 6 FT</p> <p><b>HW9</b> - Hardware 9 FT</p> <p><b>HWX</b> - Hardware custom FT</p> <p><b>DC3</b> - DC plug 3 FT</p> <p><b>DC6</b> - DC plug 6 FT</p> <p><b>DC9</b> - DC plug 9 FT</p> <p><b>DCX</b> - DC plug custom FT</p> <p><b>SUS</b> - Coaxial wire 15 Ft</p> <p><b>NO</b> - No lead</p>	<p><b>I</b> - IP22 indoor dry location</p>	<p><b>A</b> - Non-dimming</p> <p><b>B</b> - ELV dimming 120V AC</p> <p><b>C</b> - ELV dimming 120/277 VAC**</p> <p><b>D</b> - 0/10V dimming 120/277 VAC</p> <p><b>E</b> - Non-dimming DC plug in</p> <p><b>F</b> - DMX</p> <p><b>G</b> - Lutron - HI-LUME PREMIER 0,1% Eco System 24V/96W</p> <p><b>I</b> - Casambi CBU-A2D-0/10V-DALI-Bluetooth 100/277 VAC</p> <p><b>J</b> - Casambi CBU-PWM4-4CH-Bluetooth 100/277 VAC</p> <p><b>K</b> - Casambi CBU-TED-CV-Trail edge dim-Bluetooth 120 VAC</p> <p><b>NO</b> - No driver</p>	<p><b>Total length of LED engine in inches</b> - See Appendix 3 on how to calculate length.</p>
COLOR TEMPERATURE CCT	LUMEN PACKAGE	LEAD IN      LEAD OUT	USAGE	POWER SUPPLY / CONTROL	LED ENGINE LENGTH

\*NOTE: The light output is provided in lumens per foot, for a CCT of 4200K and a clear lens. Please refer to the optics page for CCT and translucency conversion factors. \*\* Only available in 96W - 24V Driver



# LUMINAIRES







# EXA

Luminaire Series



## Cross-section dimensions:

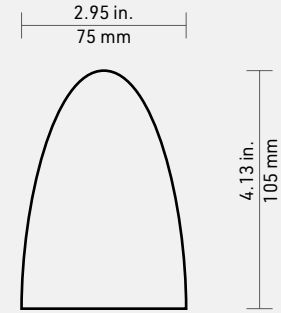

## A SUSPENDED LUMINAIRE THAT WILL INSPIRE YOU

Introducing EXA, a new suspended luminaire that will inspire you. With an elegant and clean design featuring a honeycomb diffuser that evokes the wings of an airplane. Made of extruded aluminum, this architectural grade luminaire features anti-glare technology for incomparable visual comfort. Available in seven colors, this unique and modern luminaire will enhance your décor.

The EXA luminaire provides exceptional lighting quality, ideal for office and condos. It is powered by an integrated 120 V driver with the option of adding ELV or 0-10 V - 120/277 VAC dimmer.

### FEATURES

- Ideal for work spaces
- 1832 Lumens delivered
- Antiglare design for optimal visual comfort
- 3 color temperature: 3000 K, 3500 K and 4000 K
- 7 body colors: black and white in a textured matte finish, silver in a matte finish, yellow, blue, green and orange in a semi-gloss finish
- Excellent value for the price

### LENGTH

54.33 in, 1380 mm

### WEIGHT

9.25 lbs, 4.2 kg





## ADD A SPLASH OF COLOR!

Be bold! EXA comes in seven different body colors that will match any decor. You can even order a custom color, just give us a RAL number and we'll do the rest.

**Midnight Black**



**Frost White**

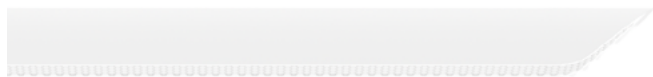

**Cloudy Grey**



**Fiery orange**



**Spring green**



**Spark Yellow**



**Azure Blue**















**EXA DIMENSIONS**







TECHNICAL DATA			
<b>Dimension</b>	54.33 x 4.13 x 2.95 in	<b>CRI</b>	+80
<b>Weight</b>	9.25 lbs, 4.2 kg	<b>Beam Angle</b>	72.8°
<b>Input Power</b>	37.8W	<b>Input Voltage</b>	120/277V
<b>Efficacy</b>	51.1 Lm/W	<b>CCT</b>	3000 K, 3500 K, 4000 K
<b>Insulation Class</b>	Class 1		

LUMINAIRE	LENS DOWN	MOUNTING HARDWARE	CANOPY	LENGTH
 <b>EXA0</b> - Cloudy Grey	 <b>H</b> - Honeycomb	 Suspension kit with 54 in. power cable <b>SUS0</b> - Alu	 <b>Canopy plate</b> See Appendix 2 on page 158 <b>CR</b> - Same color as luminaire  NOTE: The canopy will be the same color as the luminaire. Please call your agent for special orders.	<b>54</b> - EXA luminaire 54.33 inches
 <b>EXA1</b> - Midnight Black (textured matte color)				
 <b>EXA2</b> - Frost White (textured matte color)				
 <b>EXA4</b> - Fiery Orange <i>*Similar to RAL2003</i>				
 <b>EXA5</b> - Spring Green <i>*Similar to RAL6018</i>				
 <b>EXA6</b> - Spark Yellow <i>*Similar to RAL1021</i>				
 <b>EXA7</b> - Azure Blue <i>*Similar to RAL5010</i>				
 <b>EXAX</b> - Custom color IMPORTANT: Give RAL color No See Appendix 1 on page 158				

RAL NUMBER

	<b>H</b>	<b>SUS0</b>	<b>CR</b>	<b>54</b>
LUMINAIRE COLOR FINISH	LENS DOWN	MOUNTING HARDWARE	CANOPY	LENGTH

COLOR TEMPERATURE	LUMEN PACKAGE	POWER CABLE FINISH	USAGE	POWER SUPPLY/CONTROL
 <b>30</b> - 3000K  <b>35</b> - 3500K  <b>40</b> - 4000K	<b>LP</b> - 1832 LM	 <b>WH</b> - White  <b>OPTION</b>  <b>BK</b> - Black for black casing only	<b>I</b> - INTERIOR	<b>C</b> - ELV dimming 120/277V AC <b>D</b> - 0/10V dimming 120/277V AC <b>H</b> - Lutron - LUTRON - HI-LUME 1% Eco System EXA UPGRADE <b>I</b> - Casambi CBU-A2D-0/10V-DALI-Bluetooth 100/277 VAC
COLOR TEMPERATURE CCT	LUMEN PACKAGE	POWER CABLE FINISH	USAGE	POWER SUPPLY/CONTROL

	<b>LP</b>		<b>I</b>	
	LUMEN PACKAGE		USAGE	

# FULLMOON - SURFACE MOUNT

Luminaire Series



## Cross-section dimensions:

Full Moon 18"

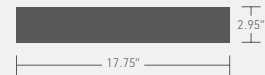

Full Moon 36"

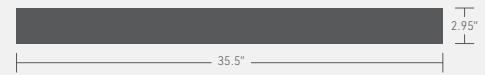

## FULL POWER WITH FULLMOON!

Introducing FullMoon, the new architectural-grade luminaire from LumenTruss™ designed to be suspended or surface mounted. Offering direct and indirect lighting that enhances its elegant and luxurious design, it has everything to impress. The outstanding quality of OSRAM light sources with their very high light output makes it very attractive for large spaces. And the microprism lens, developed with the latest glare-free technology, provides exceptional visual comfort. It is a luminaire of first choice for high or very high ceiling applications such as hotel lobbies or office towers. Exclusive to LumenTruss™.

### FEATURES

- 3 sumptuous finishes: white, black or black and gold
- 2 diameters: 17 ¾ in (45 cm) and 35 ½ in (90 cm)
- Up and down lighting
- OSRAM high-end light sources, CRI 90+
  - Light output: 17 ¾ in (45 cm) luminaire, 26W = 950 lumen ↑ and 2400 lumen ↓
  - Light output: 35 ½ in (90 cm) luminaire, 68W = 2200 lumen ↑ and 7300 lumen ↓
- 2 color temperatures: 3000 K and 3500 K
- Microprism lens with anti-glare technology reducing eye fatigue
- Surface or suspended installation with aerospace-grade cable or suspension rod (39 in/1 m)
- Indoor installation, IP22

### WEIGHT



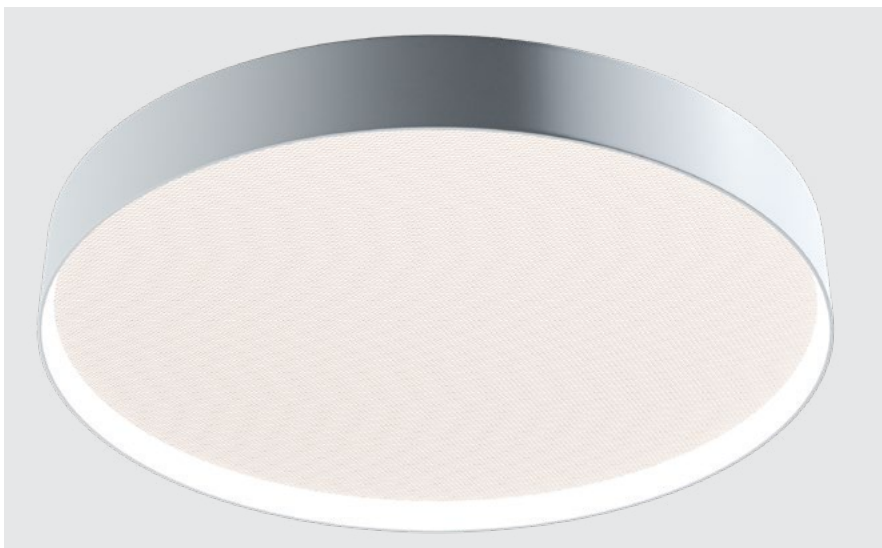

FullMoon 18: 1.288 lbs (2.232 kg)  
FullMoon 36: 7.6064 lbs (3.450 kg)







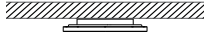



LUMINAIRE	LENS	MOUNTING HARDWARE
 <b>1801</b> - Black 18" diameter <b>3601</b> - Black 36" diameter	 <b>A</b> - Anti-glare	 <b>SM</b> - Surface mount
 <b>1802</b> - White 18" diameter <b>3602</b> - White 36" diameter		
 <b>1803</b> - Black & Gold 18" diameter <b>3603</b> - Black & Gold 36" diameter		

LUMINAIRE COLOR FINISH	<b>A</b>	<b>SM</b>
	LENS	MOUNTING HARDWARE

Luminaire

COLOR TEMPERATURE	LUMEN PACKAGE	USAGE	POWER SUPPLY/CONTROL
 <b>30</b> - 3000K  <b>35</b> - 3500K	FOR 18" (26W) <b>D18</b> - 2400 LM (down) <b>DU18</b> - 2400LM / 950 LM (up + down)  FOR 36" (68W) <b>D36</b> - 7300 LM (down) <b>DU36</b> - 7300 LM / 2200LM (up + down)	<b>I</b> - IP22 indoor dry location	<b>C</b> - ELV dimming 120/277VAC <i>*ELV dimming only available for 18"</i> <b>D</b> - 0/10V dimming 120/277V AC <b>I</b> - Casambi CBU-A2D-0/10V-DALI-Bluetooth 100/277 VAC

COLOR TEMPERATURE CCT	LUMEN PACKAGE	<b>I</b>	POWER SUPPLY/CONTROL
-----------------------	---------------	----------	----------------------

# FULLMOON - SUSPENDED

Luminaire Series



## Cross-section dimensions:

Full Moon 18"

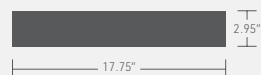

Full Moon 36"

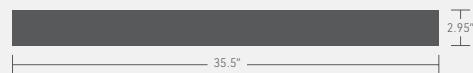

## FULL POWER WITH FULLMOON!

Introducing FullMoon, the new architectural-grade luminaire from LumenTruss™ designed to be suspended or surface mounted. Offering direct and indirect lighting that enhances its elegant and luxurious design, it has everything to impress. The outstanding quality of OSRAM light sources with their very high light output makes it very attractive for large spaces. And the microprism lens, developed with the latest glare-free technology, provides exceptional visual comfort. It is a luminaire of first choice for high or very high ceiling applications such as hotel lobbies or office towers. Exclusive to LumenTruss™.

### FEATURES

- 3 sumptuous finishes: white, black or black and gold
- 2 diameters: 17 ¾ in (45 cm) and 35 ½ in (90 cm)
- Up and down lighting
- OSRAM high-end light sources, CRI 90+
  - Light output: 17 ¾ in (45 cm) luminaire, 26W = 950 lumen ↑ and 2400 lumen ↓
  - Light output: 35 ½ in (90 cm) luminaire, 68W = 2200 lumen ↑ and 7300 lumen ↓
- 2 color temperatures: 3000 K and 3500 K
- Microprism lens with anti-glare technology reducing eye fatigue
- Surface or suspended installation with aerospace-grade cable or suspension rod (39 in/1 m)
- Indoor installation, IP22





### WEIGHT

FullMoon 18: 1.288 lbs (2.232 kg)  
FullMoon 36: 7.6064 lbs (3.450 kg)



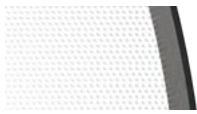
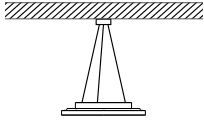

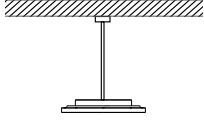

LUMINAIRE	LENS	MOUNTING HARDWARE
 <b>1801</b> - Black 18" diameter <b>3601</b> - Black 36" diameter	 <b>A</b> - Anti-glare	 <b>CS</b> - Cable suspension 39"
 <b>1802</b> - White 18" diameter <b>3602</b> - White 36" diameter		 <b>RS</b> - Rod suspension 43"
 <b>1803</b> - Black & Gold 18" diameter <b>3603</b> - Black & Gold 36" diameter		

LUMINAIRE COLOR FINISH	<div style="border: 1px solid black; padding: 5px; display: inline-block;"><b>A</b></div>	MOUNTING HARDWARE
	LENS	

Luminaire

COLOR TEMPERATURE	LUMEN PACKAGE	USAGE	POWER SUPPLY/CONTROL
<div style="display: flex; gap: 10px;"> <div style="width: 15px; height: 10px; background-color: #f0e68c; border: 1px solid black;"></div> <b>30</b> - 3000K  <div style="width: 15px; height: 10px; background-color: #f0e68c; border: 1px solid black;"></div> <b>35</b> - 3500K                 </div>	FOR 18" (26W) <b>D18</b> - 2400 LM (down) <b>DU18</b> - 2400LM / 950 LM (up + down)  FOR 36" (68W) <b>D36</b> - 7300 LM (down) <b>DU36</b> - 7300 LM / 2200LM (up + down)	<b>I</b> - IP22 indoor dry location	<b>C</b> - ELV dimming 120/277VAC <i>*ELV dimming only available for 18"</i> <b>D</b> - 0/10V dimming 120/277V AC <b>I</b> - Casambi CBU-A2D-0/10V-DALI-Bluetooth 100/277 VAC

COLOR TEMPERATURE CCT	LUMEN PACKAGE	<div style="border: 1px solid black; padding: 5px; display: inline-block;"><b>I</b></div>	POWER SUPPLY/CONTROL
		USAGE	

# SERZO 2.0

Luminaire Series

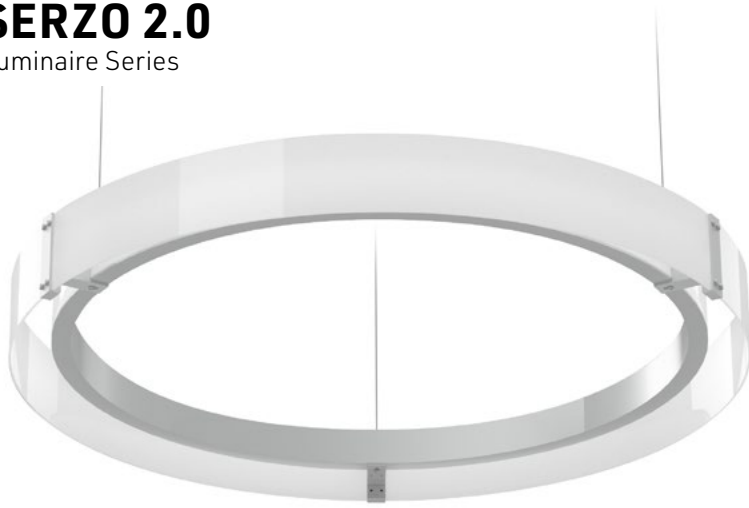

## Cross-section dimensions:

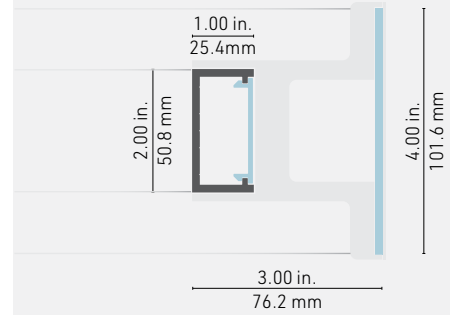

Introducing the impressive SERZO ring luminaire system, an exclusive series at LumenTruss™. The Serzo can be suspended horizontally in different angles to create a spectacular visual effect. Available in three fixed diameters of 36, 54 and 72 inches<sup>1</sup>, they provide 360 degrees, even, dot-free omnidirectional lighting, making them particularly attractive for large spaces. The design of each ring incorporates an offset acrylic opal diffuser that gives this exceptional luminaire an elegant and refined look.

(1) Overall diameter with offset acrylic diffusers.

## FEATURES

- Anodized aluminum, white, black, or custom finishing.
- 180 LED/m light source with single or double installation for high power.
- Overall diameter of 36, 54 and 72 inches.
- Made of ALCOA 6063-T5 aluminum alloy that increases heat dissipation.

## OPTIONS



## LED ENGINE COMPATIBILITY

The LED channel is compatible with multiple LED engines, up to **36mm (1.42")** wide in total.

## WEIGHT

Serzo36: 1.288 lbs (2.232 kg)  
Serzo54: 7.6064 lbs (3.450 kg)  
Serzo72: 10.291 lbs (4.668 kg)









The weight varies significantly depending on product configuration. Figures provided are for the LED profiles only without lenses, mounting hardware, diffusers or reflectors.









PROFILE	LENSES	SUSPENSION	OUTER RING	CANOPY
 <p>Serzo 36 - Profile, 32" O.D.  <b>S362</b> - White  <b>S361</b> - Black  <b>S36X</b> - Custom color</p> <p><b>IMPORTANT:</b> Give RAL color No            See Appendix 1 on page 158</p>	 <p><b>OX</b> - Serzo optiflex lens</p>	 <p>Horizontal suspension kit with            diffuser/reflector mount and 15ft.            aircraft cable  <b>SUS2</b> - White  <b>SUS1</b> - Black  <b>SUS3</b> - Graphite</p>	 <p><b>AC</b> - 4" Acrylic diffuser</p>	 <p><b>Remote driver canopy plate</b>            See Appendix 2 on page 158  <b>CR0</b> - Alu  <b>CR1</b> - Black  <b>CR2</b> - White</p>
<p>RAL NUMBER</p>  <p>Serzo 54 - Profile, 50" O.D.  <b>S542</b> - White  <b>S541</b> - Black  <b>S54X</b> - Custom color</p> <p><b>IMPORTANT:</b> Give RAL color No            See Appendix 1 on page 158</p>				 <p><b>Integrated driver in canopy</b>            See Appendix 2 on page 158  <b>CI0</b> - Alu  <b>CI1</b> - Black  <b>CI2</b> - White</p>
<p>RAL NUMBER</p>  <p>Serzo 72 - Profile, 68" O.D.  <b>S722</b> - White  <b>S721</b> - Black  <b>S72X</b> - Custom color</p> <p><b>IMPORTANT:</b> Give RAL color No            See Appendix 1 on page 158</p>				 <p><b>NO</b> - No canopy</p>



COLOR TEMPERATURE	LUMEN PACKAGE*	USAGE	POWER SUPPLY/CONTROL**	*NOTES
<ul style="list-style-type: none"> <li><span style="display: inline-block; width: 15px; height: 10px; background-color: #f4a460; border: 1px solid black; margin-right: 5px;"></span> 24 - 2400K</li> <li><span style="display: inline-block; width: 15px; height: 10px; background-color: #f08080; border: 1px solid black; margin-right: 5px;"></span> 27 - 2700K</li> <li><span style="display: inline-block; width: 15px; height: 10px; background-color: #f4c48c; border: 1px solid black; margin-right: 5px;"></span> 30 - 3000K</li> <li><span style="display: inline-block; width: 15px; height: 10px; background-color: #f0e68c; border: 1px solid black; margin-right: 5px;"></span> 35 - 3500K</li> <li><span style="display: inline-block; width: 15px; height: 10px; background-color: #f0f0f0; border: 1px solid black; margin-right: 5px;"></span> 42 - 4200K</li> </ul>	<p>SERZO 36*<b>36L</b> - 3558 LM / 48W / 90+CRI</p> <p><b>36H</b> - 4234 LM / 71.78W / 90+CRI</p> <p>SERZO 54*</p> <p><b>54L</b> - 5574 LM / 75.3W / 90+CRI</p> <p><b>54H</b> - 6720 LM / 113.96W / 90+CRI</p> <p>SERZO 72*</p> <p><b>72L</b> - 7604 LM / 102.7W / 90+CRI</p> <p><b>72H</b> - 9164 LM / 155.4W / 90+CRI</p>	<p>I - IP22 indoor dry location</p>	<p><b>A</b> - Non-dimming</p> <p><b>B</b> - ELV dimming 120V AC</p> <p><b>C</b> - ELV dimming 120/277 VAC***</p> <p><b>D</b> - 0/10V dimming 120/277 VAC</p> <p><b>E</b> - Non-dimming DC plug in</p> <p><b>F</b> - DMX</p> <p><b>G</b> - Lutron - HI-LUME PREMIER 0,1% Eco System 24V/96W</p> <p><b>I</b> - Casambi CBU-A2D-0/10V-DALI-Bluetooth 100/277 VAC</p> <p><b>J</b> - Casambi CBU-PWM4-4CH-Bluetooth 100/277 VAC</p> <p><b>K</b> - Casambi CBU-TED-CV-Trail edge dim-Bluetooth 120 VAC</p> <p><b>NO</b> - No driver</p>	<p>* The light output is provided in lumens per foot, for a CCT of 4200K and a clear lens. Please refer to the optics page for CCT and translucency conversion factors.</p> <p>** 54H and 72H lumen packages require installation of two drivers.</p> <p>*** Only available in 96W - 24V Driver</p>

COLOR TEMPERATURE CCT - LUMEN PACKAGE - USAGE - POWER SUPPLY/CONTROL

# STRUSS DOWN

Luminaire Series



## Cross-section dimensions:

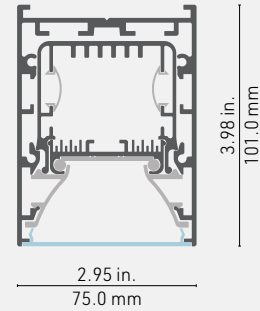

Available in two popular lengths, the STRUSS is a linear lighting system designed to be suspended. With its minimalistic style, it is robust and powerful. With a CRI of 92+, **UL certified LED engines** provide exceptional linear lighting quality, in high power. It is equipped with an Optiflex lens that scatters light evenly, dot-free, in a 120-degree beam. **Exclusive, tool-free assembly** eliminates hardware clutter for a clean look. Ideal for offices and commercial spaces.

## FEATURES

- Dimensions: 3" wide, 4" high and 48" (4 ft) or 96" (8 ft) length.
- Choice of 4 color temperatures (3000 K, 3500 K, 4000 K and 5000K) and 4 high power rigid PCBs.
- Driver integrated in an internal housing for additional protection.
- Toolless mounting kit with rubber splines and strong magnetic endcaps, exclusive to LumenTruss™.
- Suspension cables can be installed anywhere on top of the luminaire for greater installation flexibility.

## OPTIONS



## LED ENGINE COMPATIBILITY

STRUSS is designed for use with proprietary rigid 1.5in wide LED PCBs.

## LINEAR WEIGHT

2.863 lbs/ft, 4.261 kg/m

Figures provided for the aluminum profiles only – outer and inner enclosures, heatsink. The complete assembly, with LED light sources, reflectors, power supplies, endcaps, mounting hardware etc. will be greater, and will vary depending on product configuration.



# STRUSS DOWN ordering sheet

# Luminaire Series

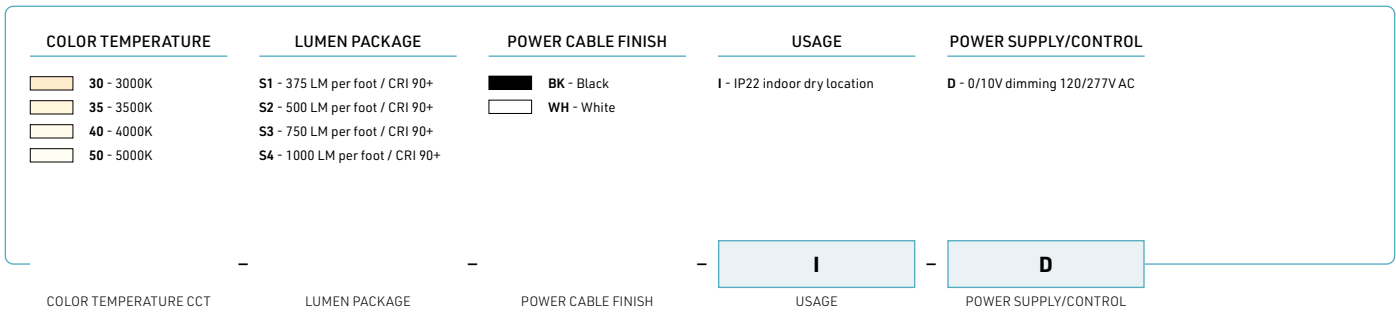
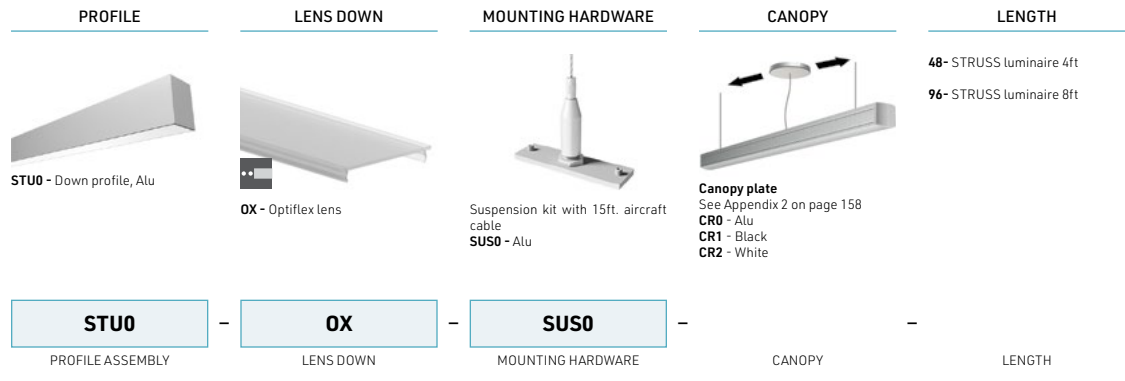

Luminaire

# TASKLINE

Luminaire Series



## Cross-section dimensions:

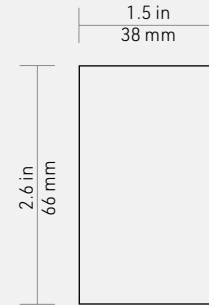

## VISUALLY DISCREET AND YET SO POWERFUL

Introducing TaskLine, the first up and down, glare-free, miniature linear lighting system in its category. You can easily connect more than one TaskLine with our quick-link system to create a continuous run.

The highly esthetic TaskLine square-in-square optical system delivers superior visual comfort, flawless color mixing and uniform lighting. Boasting an efficacy of up to 118 lm/W and an output of up to 762 lm/ft, this linear downlight is suited for general lighting and high-ceiling applications. Available in silver, white and black finish.

## UP & DOWN LIGHTING

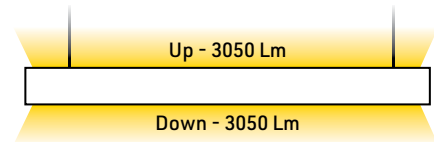

## FEATURES

- Ability to connect more than one unit with our quick-link design.
- Up and down lighting.
- Integrated 0-10 V dimming solution.
- Anti-glare technology reducing eye fatigue.
- Very powerful lighting, convenient for work and commercial spaces.

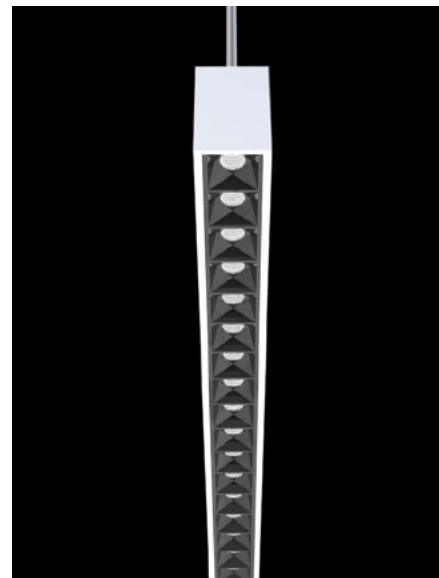
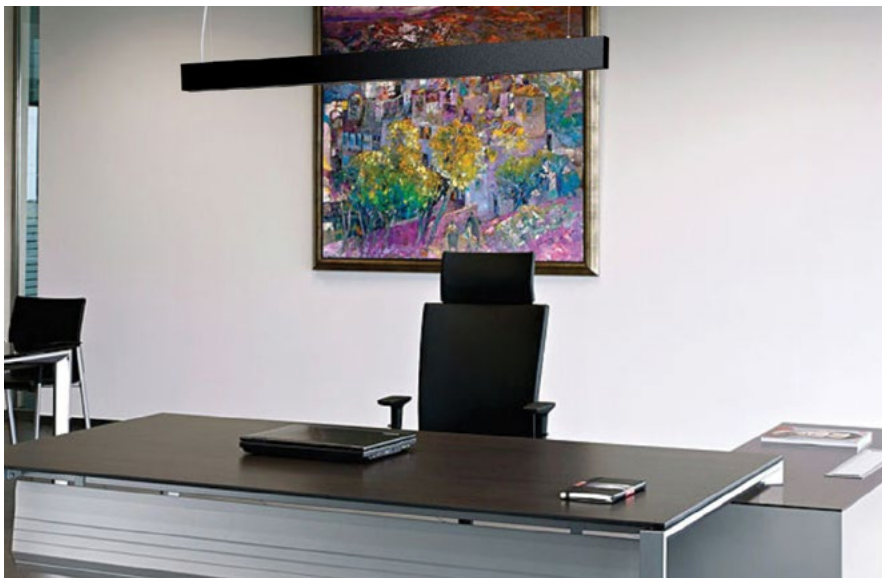

# LINKABLE DESIGN

Easily connect additional taskline with our quick link design.



## QUICK LINK DESIGN

Our Quick Link system bring new flexibility to linear lighting systems. Easily and quickly combine up to 15 units to create a continuous run design.

Our Quick Link design open up fresh choices for design flexibility and custom approaches.

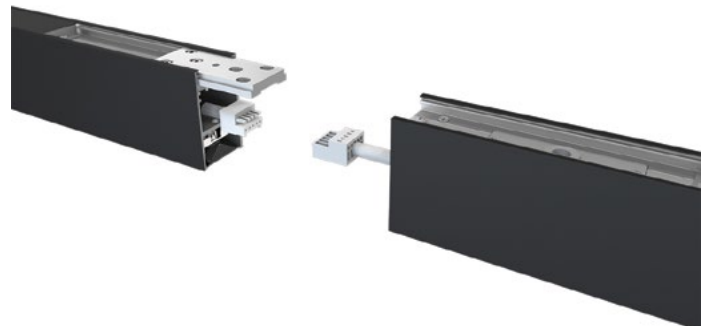

## CERTIFIED QUALITY



From the time of design and conception, through the final manufacturing process, LumenTruss quality is controlled and backed by leading certification authorities to ensure that you get a product that is guaranteed to perform to your expectations.





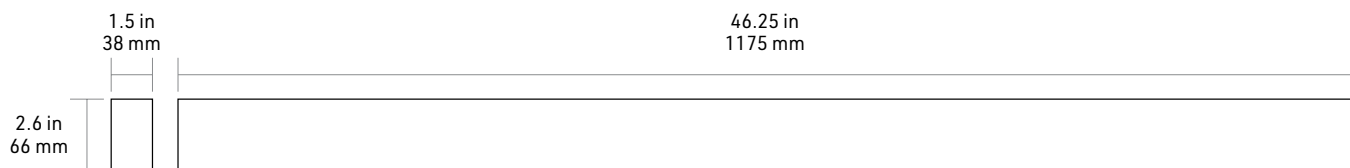









#### TASKLINE DIMENSIONS



#### TECHNICAL DATA

<b>Dimension</b>	46.25 x 2.6 x 1.5 in	<b>Max. Interconnected units</b>	15
<b>Weight</b>	7 lbs / 3.2 kg	<b>CRI</b>	+80
<b>Power</b>	25W up, 25W down	<b>Beam Range</b>	50 degree
<b>Efficacy</b>	118 lm/W	<b>Input</b>	120/277 VAC - 50/60Hz
<b>Lumen Output</b>	762 Lm/ft		

LIGHTING SYSTEM	COLOR TEMPERATURE	QUANTITY
 <p><b>TASKLINE-50W, SILVER</b> Up/Down-0-10V</p>	3000K  (special order)*	<b>LM00001-38</b>
	3500K  (special order)*	<b>LM00001-40</b>
	4000K  (special order)*	<b>LM00001-39</b>
 <p><b>TASKLINE-50W, BLACK</b> Up/Down-0-10V</p>	3000K  (in stock)	<b>LM00001-49</b>
	3500K  (special order)*	<b>LM00001-47</b>
	4000K  (in stock)	<b>LM00001-55</b>
 <p><b>TASKLINE-50W, WHITE</b> Up/Down-0-10V</p>	3000K  (in stock)	<b>LM00001-50</b>
	3500K  (special order)*	<b>LM00001-48</b>
	4000K  (in stock)	<b>LM00001-56</b>

*\*Delivery times will be longer for special orders.*

# LIGHT TASK

Luminaire Series



## Cross-section dimensions:

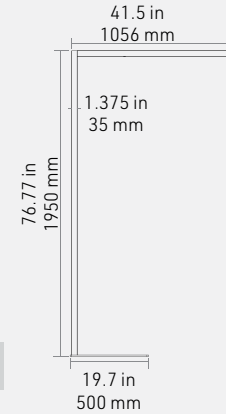

## WITH TUNABLE WHITE!

The aluminum Light Task floor lamp is designed with intelligent lighting control, daylight adjustment and movement detection. You can configure these controls to your liking and the lamp will automatically turn on when sensing your presence and adjust its lighting output so that a relatively constant level of illumination is maintained throughout the day. Its straight and clean lines will give a modern look to your decor.

### FEATURES

- Configurable daylight sensor and motion sensor.
- Daylight adjustment directly and indirectly.
- Regulation of amount of light when absent, resuming automatically by motion sensor.
- Manual dimming available for room light (indirect light) and direct light.
- Anti-glare technology reducing eye fatigue.

### UP & DOWN LIGHTING

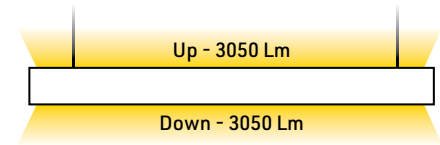

### VARIABLE COLOR

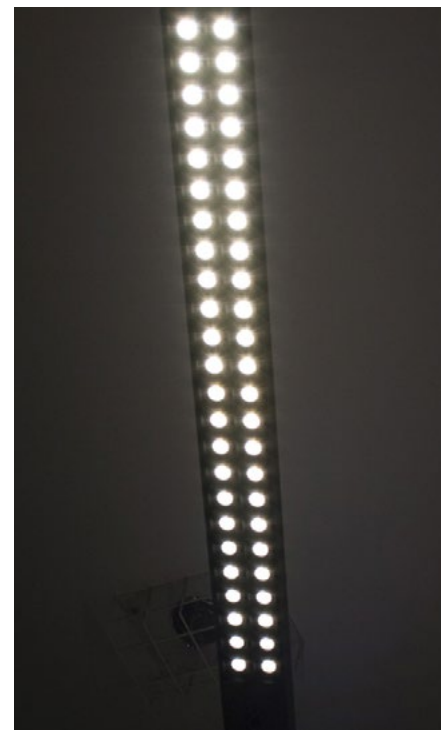



# A WIDE RANGE OF SETTINGS

Use the touch panel to manually adjust the light intensity.

## SENSORS AND SETTING SWITCH



SWITCH POSITION	MOTION SENSOR	DAYLIGHT SENSOR
0	OFF	OFF
1	ON	OFF
2	ON	ON
3	OFF	ON

## MOTION SENSOR

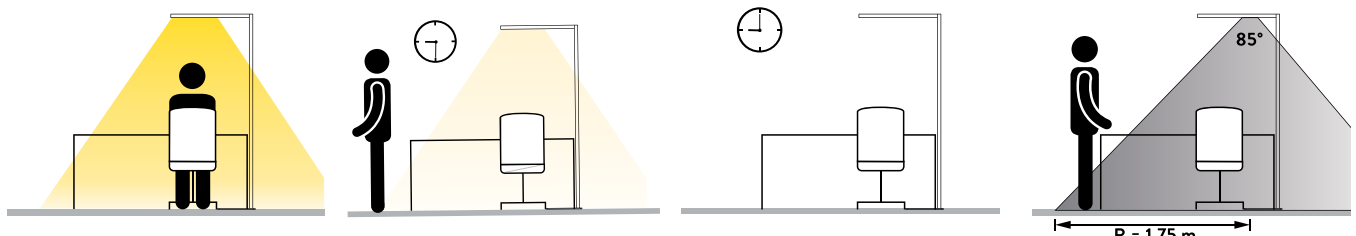

Turn on the lamp.

After 30 min, without presence, output of the luminaire is reduced to 30% automatically.

After 30 min, without presence, output of the luminaire automatically switches off.

When presence detected, the luminaire switches on immediately. Detection angle 85°

## DAYLIGHT SENSOR

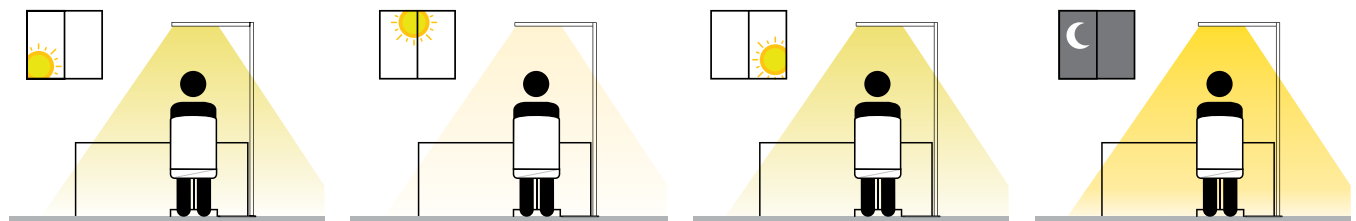

After each manual dimming, the set value is stored together with the value of the ambient light, measured by the sensor.

When the ambient light change or re-dimming, the output of the lamp is adjusted so that a relatively constant level of illumination are maintained, optimal for desk work.

## TOUCH PANEL



**Upper area:**  
 - Indirect light On/Off switch  
 - indirect light: dimming

**Middle area:**  
 - On/Off switch  
 - Adjust color temperature in tunable white.

**Lower area:**  
 - Direct light On/Off switch  
 - Direct light: dimming

## CERTIFIED QUALITY



From the time of design and conception, through the final manufacturing process, LumenTruss quality is controlled and backed by leading certification authorities to ensure that you get a product that is guaranteed to perform to your expectations.

# WITH SEPARATE UP & DOWN CONTROLS, LIGHT TASK GIVES YOU MANY OPTIONS



## LIGHT TASK DIMENSIONS

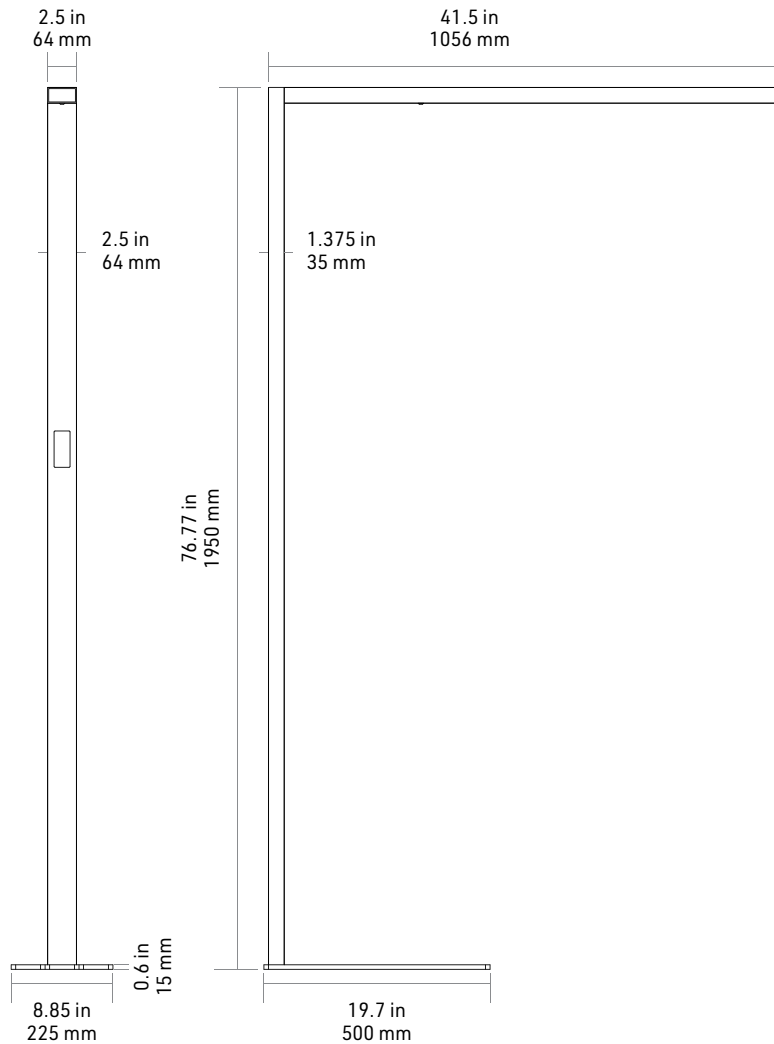

### TECHNICAL DATA

<b>Dimension</b>	46.25 x 2.6 x 1.5 in	<b>Beam angle</b>	50° direct, 120° indirect
<b>Power</b>	25W up, 25W down	<b>Dimming</b>	Touch-dim
<b>Power Consumption</b>	80kwh/1000h	<b>Protection Rating</b>	IP20
<b>Lumen Output</b>	762 Lm/ft	<b>Warranty</b>	5 year warranty

LUMINAIRE TYPE	QUANTITY
 LIGHT TASK, SILVER	LM00001-25
 LIGHT TASK, BLACK	LM00001-45
 LIGHT TASK, WHITE	LM00001-46



## RECESSED & TRACK LIGHT SYSTEM





# OMEGA

4" Recessed Downlight



## Trims dimensions:

RA2 - SA2

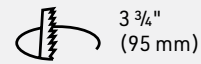

RS2

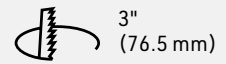

RR2

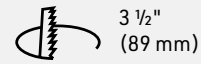

KT0 - KT1 - KT2

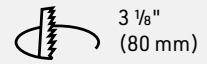

The quality of light of this Series is comparable to that of a halogen lamp offering crisp, directional light which perfectly highlights surroundings. It offers a CRI of 90 and glare-control reflector design.

This small LED module provides higher lumen performance than an LED lamp and is very easy to install. Without the need of a housing, it is installed directly in the ceiling using torsion springs and most models are IC rated. The LED module is fitted with an external dimmable driver. Omega is also offering style, discretion and flexibility with a wide selection of interchangeable trims and accessories.

## FEATURES

- Anti-glare reflector design UGR  $\leq$  19
- Available in 6 W (IC rated) with three different beam angle options: 22°, 36° and 60°
- Reproduces the crisp white light of an MR16 halogen lamp
- 50 000 hours
- High CRI of 90
- Discreet look and sleek design
- Dimmable
- Designed to meet North American woodworking standards.





## OMEGA TRIMLESS KIT - MODERN & STUNNING

### AN INSTANT CLASSIC

The Omega trimless kit is our new favorite LED Recessed luminaire! Minimalist with the newest in technology. The kit is available in silver, white or black. One of the advantages is that it is designed to be plastered into ceilings to give a seamless appearance. A great choice to get a clean and modern look.

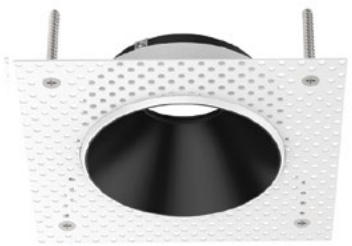

Kit Trimless Black

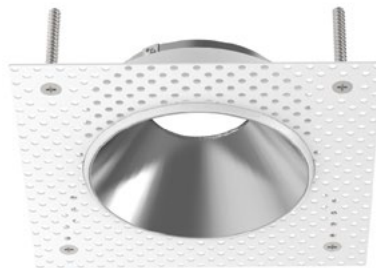

Kit Trimless Silver



Kit Trimless White

Recessed



## OMEGA MODULES AND TRIMS DIMENSIONS

### QUALITY CONSTRUCTION

The Omega Series is designed and manufactured using high quality materials.

### EASE OF INSTALLATION

This LED downlight is easy to install with no need for a housing and it comes equipped with torsion springs.

### VERSATILITY

With interchangeable trims and reflectors, this product can be adapted to all types of designs and applications.

### PLEASING LIGHT

The Omega Series reproduces the crisp white look of a halogen MR16 lamp at a fraction of the energy cost

### SUPERIOR PERFORMANCE

The Omega Series produces more light output than a regular LED MR16 or GU10 lamp.

RA2 - SA2

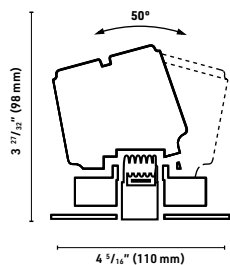

3 3/4" (95 mm)

RS2

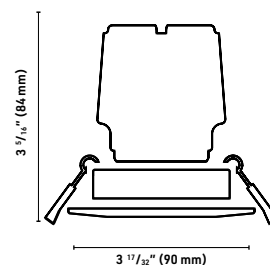

3" (76.5 mm)

RR2

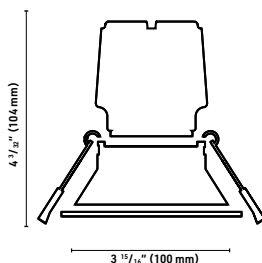





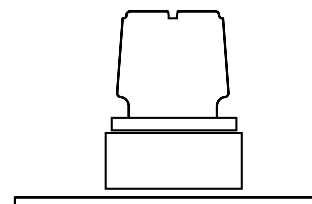





3 1/2" (89 mm)

KT0 - KT1 - KT2



3 1/8" (80 mm)



TRIM	LUMINOSITY	COLOR TEMPERATURE	BEAM ANGLE	POWER SUPPLY	ACCESSORIES	QUANTITY
 <p><b>KIT0</b> - Kit trimless silver 3 1/8" (80 mm)</p>	<p>670 - 670 lm (6W) CRI 90+</p> <p>900 - 900 lm (8W)* CRI 90+</p> <p><i>*900 lm is not IC rated. May need insulated box (see accessories).</i></p>	<p>27 - 2700K (in stock)</p> <p>30 - 3000K (in stock)</p> <p>35 - 3500K (in stock)</p> <p>40 - 4000K (special order)*</p> <p><i>*Delivery times will be longer for special orders.</i></p>	<p>22 - 22 degrees</p> <p>36 - 36 degrees</p> <p>60 - 60 degrees</p>	<p><b>*Included</b></p> <p>B - ELV dimming 120V AC</p> <p>D - 0-10V dimming 120/277V AC</p>	<p><b>New construction plaster frame</b></p>  <p>PF1 - cut-out size 3" for RS2</p> <p>PF2 - cut-out size 3 1/8" for KIT0 - KIT1 - KIT2</p> <p>PF3 - cut-out size 3 1/2" for RR2</p> <p>PF4 - cut-out size 3 3/4" for RA2 - SA2</p> <p><b>New construction IC box*</b> <i>*Use only with 900 lm</i></p>  <p>IC1 - cut-out size 3" for RS2</p> <p>IC2 - cut-out size 3 1/8" for KIT0 - KIT1 - KIT2</p> <p>IC3 - cut-out size 3 1/2" for RR2</p> <p>IC4 - cut-out size 3 3/4" for RA2 - SA2</p> <p><b>NO</b> - No mounting accessories</p>	 <p><b>OMEGA</b></p>
 <p><b>KIT1</b> - Kit trimless black 3 1/8" (80 mm)</p>						
 <p><b>KIT2</b> - Kit trimless white 3 1/8" (80 mm)</p>						
 <p><b>RA2</b> - Round adjustable white 3 3/4" (95 mm)</p>						
 <p><b>SA2</b> - Square adjustable white 3 3/4" (95 mm)</p>						
 <p><b>RR2</b> - Round recessed white 3 1/2" (89 mm)</p>						
 <p><b>RS2</b> - Round shower white 3" (76.5 mm)</p>						

## ACCESSORIES COMPATIBILITY

	TRIMLESS	TRIM, white			
TRIM TYPE	Silver - Black - White	Round adjustable	Square adjustable	Round recessed	Round shower
TRIM CODE	KIT0 - KIT1 - KIT2	RA2	SA2	RR2	RS2
NEW CONSTRUCTION PLASTER FRAME CODE	PF2	PF4	PF4	PF3	PF1
NEW CONSTRUCTION INSULATED BOX CODE	IC2	IC4	IC4	IC3	IC1
CUT-OUT SIZE	3 1/8" (80 mm)	3 3/4" (95 mm)	3 3/4" (95 mm)	3 1/2" (89 mm)	3" (76.5 mm)

# TRAXX SPOTLIGHT

Track light system



## Cross-section dimensions:

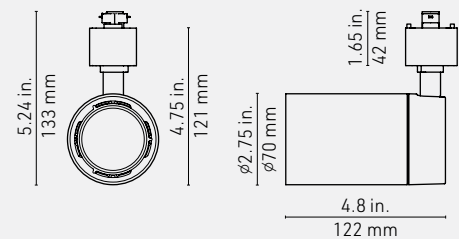

Shown: 15W model (see opposite page for 8W dimensions).



Elegant and powerful, the TRAXX track light system from LumenTruss™ enhances the decorative elements or products you want to highlight. With its interchangeable heads providing 3 projection angles and a choice of 4 color temperatures, this track-mounted spotlight is ideal for high-end applications. Its modular design, removable and tool-free, makes it an exceptionally versatile LED spotlight.

## FEATURES

- Lumen output (15W) 1200lm - 4000K
- Lumen output (8W) 465lm - 4000K
- 8W & 15 W, 120V, 50,000 hours.
- interchangeable projection angles : 15°, 38° and 60°.
- Four color temperatures to choose from: 2700K, 3000K, 3500K and 4000K.
- CAMETA anti-glare design with protective angle to reduce glare.
- Can be used with most dimmers with variable intensity.
- Integral regulators, isolated circuit.
- Passive cooling achieved through innovative thermal design.
- Rotation 350° (horizontal), adjustable to 90° (vertical).
- Compatible with Type J, Type H, and Type L.
- With a CRI of 95+.

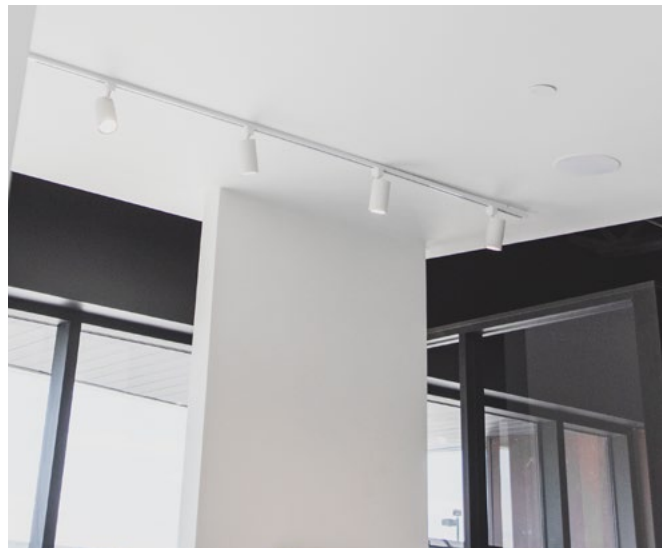

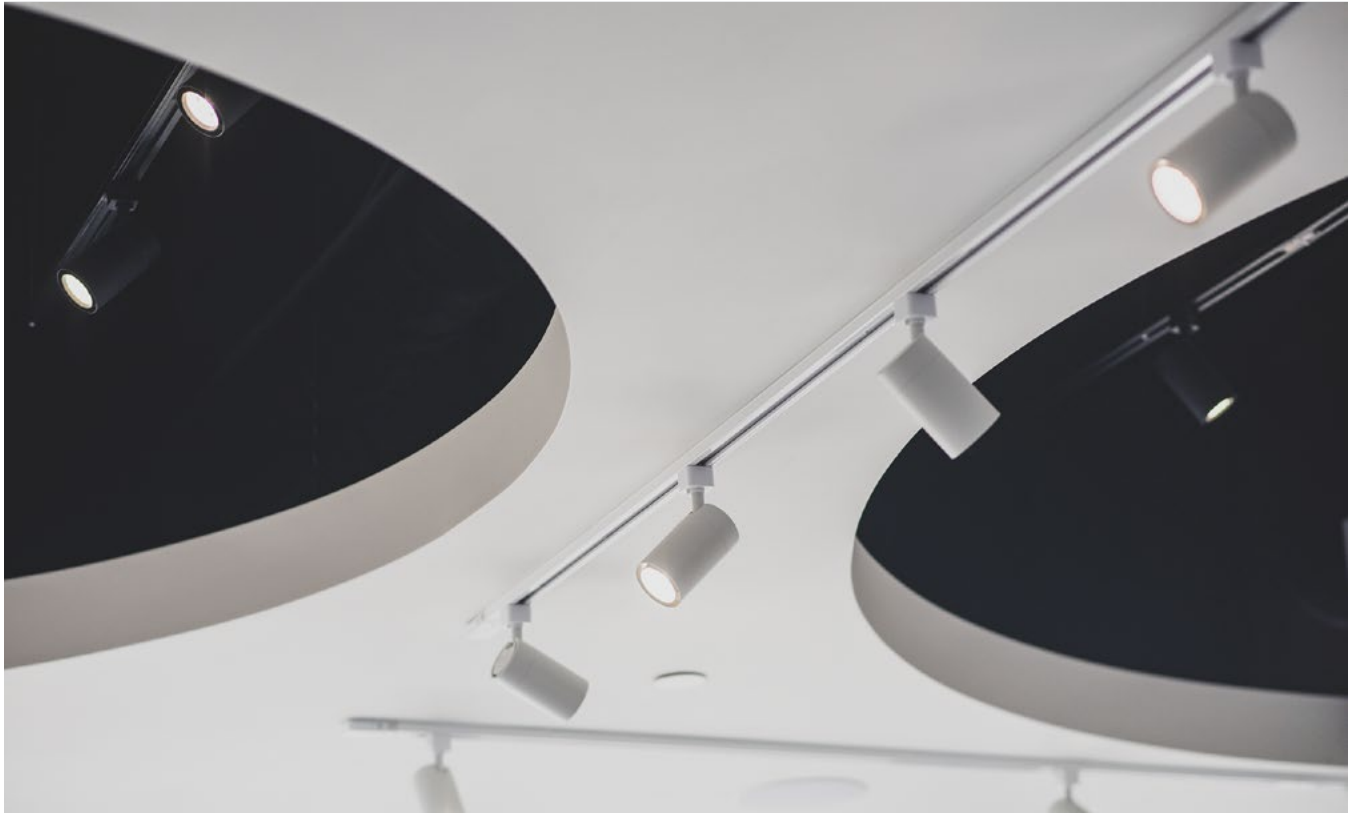

**DIMENSIONS - 15W & 8W**

**15W**

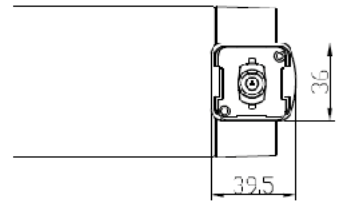
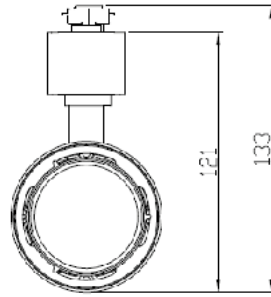
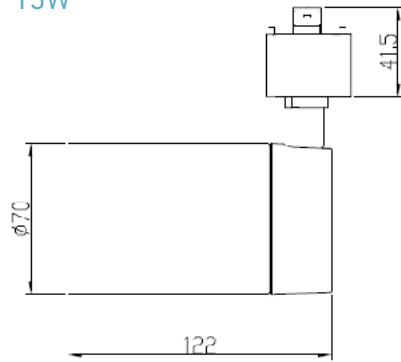



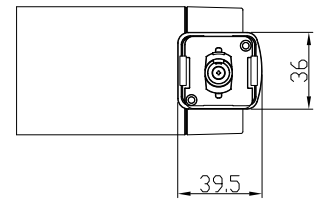
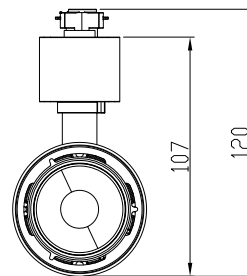
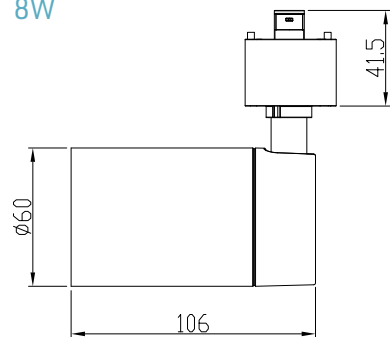











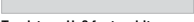







**8W**





SPOTLIGHT COLOR	INPUT POWER	COLOR TEMPERATURE	BEAM ANGLE	BASE CONNECTOR	QUANTITY
 TRX1 - Spotlight, black	8 <b>8W</b>	27 - 2700K  (special order)*	15 - 15 degrees 	TJ - Type J	
	15 <b>15W</b>	30 - 3000K  (in stock)	38 - 38 degrees 	TH - Type H	
 TRX2 - Spotlight, White		35 - 3500K  (special order)*	60 - 60 degrees 	TL - Type L	
		40 - 4000K  (in stock)			
*Delivery times will be longer for special orders.					
SPOTLIGHT COLOR	INPUT POWER	COLOR TEMPERATURE	BEAM ANGLE	BASE CONNECTOR	QUANTITY
SPOTLIGHT COLOR	INPUT POWER	COLOR TEMPERATURE	BEAM ANGLE	BASE CONNECTOR	QUANTITY

TRACK COLOR	TRACK TYPE	QUANTITY	ACCESSORIES	COLOR	QUANTITY
 Black	 Track type H, 8 feet, black LM55000-1		 Joiner connector	Black LM55002-1 	
	 Track type H, 4 feet, black LM55000-11			White LM55002 	
 White	 Track type H, 8 feet, white LM55000		 L Connector	Black LM55003-1 	
	 Track type H, 4 feet, white LM55000-10			White LM55003 	
			 T Connector	Black LM55004 	
				White LM55004 	
			 Endcap for Track	Black LM55005-1 	
				White LM55005 	
			 Live End Connector	Black LM55001-1 	
				White LM55001 	
			 Floating Canopy	Black LM55014-1 	
				White LM55014 	
			 Monopoint Canopy	Black LM55015-1 	
				White LM55015 	

Spotlight

# TRAXX PENDANT SPOTLIGHT

Track light system



Cross-section dimensions:

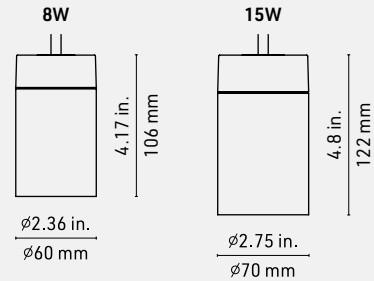

Elegant and powerful, the TRAXX pendant from LumenTruss™ enhances the decorative elements or products you want to highlight. With its interchangeable heads providing 3 projection angles and a choice of 4 color temperatures, this spotlight is ideal for high-end applications. Its modular design, removable and tool-free, makes it an exceptionally versatile LED spotlight.

## FEATURES

- Lumen output (15W) 1200lm - 4000K
- Lumen output (8W) 465lm - 4000K
- 8W & 15 W, 120V, 50,000 hours.
- interchangeable projection angles : 15°, 38° and 60°.
- Four color temperatures to choose from: 2700K, 3000K, 3500K and 4000K.
- With a CRI of 95+.
- CAMEA anti-glare design with protective angle to reduce glare.
- Can be used with most dimmers with variable intensity.
- Integral regulators, isolated circuit.
- Passive cooling achieved through innovative thermal design.

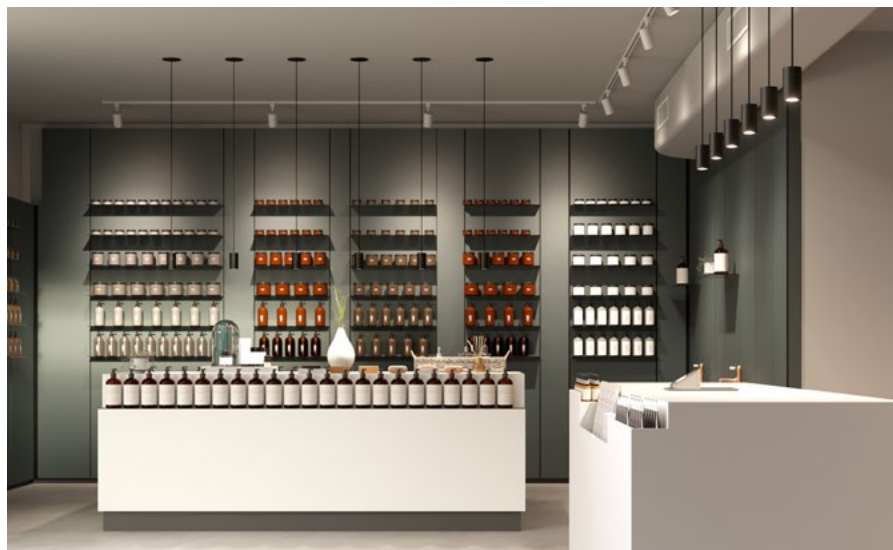







SPOTLIGHT COLOR	INPUT POWER	COLOR TEMPERATURE	BEAM ANGLE	PENDANT	QUANTITY
 TRX1 - Spotlight, black	8	27 - 2700K	15 - 15 degrees	P - Pendant with canopy	
	15	30 - 3000K	38 - 38 degrees		
	35 - 3500K	60 - 60 degrees			
	40 - 4000K				



SPOTLIGHT COLOR	INPUT POWER	COLOR TEMPERATURE	BEAM ANGLE	P	QUANTITY
SPOTLIGHT COLOR	INPUT POWER	COLOR TEMPERATURE	BEAM ANGLE	P	QUANTITY
SPOTLIGHT COLOR	INPUT POWER	COLOR TEMPERATURE	BEAM ANGLE	P	QUANTITY
SPOTLIGHT COLOR	INPUT POWER	COLOR TEMPERATURE	BEAM ANGLE	P	QUANTITY



# LED ENGINES + PSU



# B3528-XXV-60-8MM-4.8W-XXK-IPYY

LED Engines



## FEATURES

- Lumen output: 12V = 113.5 lm/ft, 24V = 128 lm/ft
- Single row, SMD 3528
- 18.3 LED/ft / 60 LED/m
- Width: 5/16 in / 8mm
- Length: 16.4ft / 5m
- 12V / 24V
- 1.46 W/ft / 4.8W/m



12V LED ENGINE - IP22	QUANTITY	12V LED ENGINE - IP68	QUANTITY
B3528-12V-60-8mm-4.8W-2700K-IP22		B3528-12V-60-8mm-4.8W-2700K-IP68	
B3528-12V-60-8mm-4.8W-3000K-IP22		B3528-12V-60-8mm-4.8W-3000K-IP68	
B3528-12V-60-8mm-4.8W-3500K-IP22		B3528-12V-60-8mm-4.8W-3500K-IP68	
B3528-12V-60-8mm-4.8W-4200K-IP22		B3528-12V-60-8mm-4.8W-4200K-IP68	
B3528-12V-60-8mm-4.8W-6200K-IP22		B3528-12V-60-8mm-4.8W-6200K-IP68	

24V LED ENGINE - IP22	QUANTITY	24V LED ENGINE - IP68	QUANTITY
B3528-24V-60-8mm-4.8W-2700K-IP22		B3528-24V-60-8mm-4.8W-2700K-IP68	
B3528-24V-60-8mm-4.8W-3000K-IP22		B3528-24V-60-8mm-4.8W-3000K-IP68	
B3528-24V-60-8mm-4.8W-3500K-IP22		B3528-24V-60-8mm-4.8W-3500K-IP68	
B3528-24V-60-8mm-4.8W-4200K-IP22		B3528-24V-60-8mm-4.8W-4200K-IP68	
B3528-12V-60-8mm-4.8W-6200K-IP22		B3528-12V-60-8mm-4.8W-6200K-IP68	

### CUSTOM OPTIONS:

SMD TYPE	INPUT VOLTAGE	LED DENSITY	STRIP WIDTH	RATED POWER	CCT	USAGE	LEAD IN / OUT	STRIP LENGTH	
<b>B3528</b>	12V - 12 volt 24V - 24 volt	60 - 60 LED/m	8mm (5/16 in.)	4.8 W/m (1.5 W/ft)	<div style="display: flex; flex-direction: column; gap: 5px;"> <div style="display: flex; align-items: center;"><span style="width: 15px; height: 10px; background-color: #f4a460; border: 1px solid black; margin-right: 5px;"></span> 2700K</div> <div style="display: flex; align-items: center;"><span style="width: 15px; height: 10px; background-color: #f4c63d; border: 1px solid black; margin-right: 5px;"></span> 3000K</div> <div style="display: flex; align-items: center;"><span style="width: 15px; height: 10px; background-color: #f4e125; border: 1px solid black; margin-right: 5px;"></span> 3500K</div> <div style="display: flex; align-items: center;"><span style="width: 15px; height: 10px; background-color: #f4f1c1; border: 1px solid black; margin-right: 5px;"></span> 4200K</div> <div style="display: flex; align-items: center;"><span style="width: 15px; height: 10px; background-color: #f4f9ff; border: 1px solid black; margin-right: 5px;"></span> 6200K</div> </div>	IP22 - indoor dry location  IP68 - wet/damp location	HW3 - Hardwire 36" HW6 - Hardwire 72" HW9 - Hardwire 108" HWX - Hardwire cust. DC3 - DC plug 36" DC6 - DC plug 72" DC9 - DC plug 108" DCX - DC plug cust. NO - No lead	Custom length up to 420 inches.  Quick ship regular roll is 196 inches - 12 in HW only.	
<b>B3528</b>		<b>60</b>	<b>8MM</b>	<b>4.8W</b>					
SMD TYPE	INPUT VOLTAGE	LED/M	WIDTH	W/M	CCT	USAGE	IN	OUT	LENGTH

\*NOTE: The light output is provided in lumens per foot, for a CCT of 4200K and a clear lens. Please refer to the optics page for CCT and translucency conversion factors.

# B3528-24V-120-8MM-4.8W-XXK-IPYY-NDA

LED Engines



## FEATURES

- Lumen output: 24V = 160 lm/ft
- Single row, SMD 3528
- 36.6 LED/ft / 120 LED/m
- Width: 5/16 in / 8mm
- Length: 16.4ft / 5m
- 24V
- 1.46 W/ft / 4.8W/m



24V LED ENGINE - IP22	QUANTITY	24V LED ENGINE - IP68	QUANTITY
B3528-24V-120-8mm-4.8W-2400K-IP22-NDA		B3528-24V-120-8mm-4.8W-2400K-IP68-NDA	
B3528-24V-120-8mm-4.8W-2700K-IP22-NDA		B3528-24V-120-8mm-4.8W-2700K-IP68-NDA	
B3528-24V-120-8mm-4.8W-3000K-IP22-NDA		B3528-24V-120-8mm-4.8W-3000K-IP68-NDA	
B3528-24V-120-8mm-4.8W-3500K-IP22-NDA		B3528-24V-120-8mm-4.8W-3500K-IP68-NDA	
B3528-24V-120-8mm-4.8W-4200K-IP22-NDA		B3528-24V-120-8mm-4.8W-4200K-IP68-NDA	
B3528-24V-120-8mm-4.8W-6200K-IP22-NDA		B3528-24V-120-8mm-4.8W-6200K-IP68-NDA	

### CUSTOM OPTIONS:

SMD TYPE	INPUT VOLTAGE	LED DENSITY	STRIP WIDTH	RATED POWER	CCT	USAGE	LEAD IN / OUT	STRIP LENGTH	
B3528 - 3.5 x 2.8mm	24V - 24 volt	120 - 120 LED/m	8mm (5/16 in.)	4.8 W/m (4.4 W/ft)	<div style="display: flex; flex-direction: column; gap: 5px;"> <div style="display: flex; align-items: center;"><span style="width: 15px; height: 10px; background-color: #f4a460; border: 1px solid black;"></span> 2400K</div> <div style="display: flex; align-items: center;"><span style="width: 15px; height: 10px; background-color: #f9c996; border: 1px solid black;"></span> 2700K</div> <div style="display: flex; align-items: center;"><span style="width: 15px; height: 10px; background-color: #fde725; border: 1px solid black;"></span> 3000K</div> <div style="display: flex; align-items: center;"><span style="width: 15px; height: 10px; background-color: #fff176; border: 1px solid black;"></span> 3500K</div> <div style="display: flex; align-items: center;"><span style="width: 15px; height: 10px; background-color: #fff9c4; border: 1px solid black;"></span> 4200K</div> <div style="display: flex; align-items: center;"><span style="width: 15px; height: 10px; background-color: #fff176; border: 1px solid black;"></span> 5300K</div> </div>	IP22 - indoor dry location  IP68 - wet/damp location	HW3 - Hardwire 36" HW6 - Hardwire 72" HW9 - Hardwire 108" HWX - Hardwire cust. DC3 - DC plug 36" DC6 - DC plug 72" DC9 - DC plug 108" DCX - DC plug cust. NO - No lead	Custom length up to 420 inches.  Quick ship regular roll is 196 inches - 12 in HW only.	
<b>B3528</b>	<b>24V</b>	<b>120</b>	<b>8MM</b>	<b>4.8W</b>					
SMD TYPE	INPUT VOLTAGE	LED/M	WIDTH	W/M	CCT	USAGE	IN	OUT	LENGTH

\*NOTE: The light output is provided in lumens per foot, for a CCT of 4200K and a clear lens. Please refer to the optics page for CCT and translucency conversion factors.

# B3528-XXV-120-8MM-9.6W-XXK-IPYY

LED Engines



## FEATURES

- Lumen output: 12V = 232.1 lm/ft, 24V = 255 lm/ft
- Single row, SMD 3528
- 36.6 LED/ft / 120 LED/m
- Width:  $\frac{5}{16}$  in / 8mm
- Length: 16.4ft / 5m
- 12V / 24V
- 2.93 W/ft / 9.6 W/m



12V LED ENGINE - IP22	QUANTITY	12V LED ENGINE - IP68	QUANTITY
B3528-12V-120-8mm-9.6W-2700K-IP22		B3528-12V-120-8mm-9.6W-2700K-IP68	
B3528-12V-120-8mm-9.6W-3000K-IP22		B3528-12V-120-8mm-9.6W-3000K-IP68	
B3528-12V-120-8mm-9.6W-3500K-IP22		B3528-12V-120-8mm-9.6W-3500K-IP68	
B3528-12V-120-8mm-9.6W-4200K-IP22		B3528-12V-120-8mm-9.6W-4200K-IP68	
B3528-12V-120-8mm-9.6W-6200K-IP22		B3528-12V-120-8mm-9.6W-6200K-IP68	

24V LED ENGINE - IP22	QUANTITY	24V LED ENGINE - IP68	QUANTITY
B3528-12V-120-8mm-9.6W-2700K-IP22		B3528-12V-120-8mm-9.6W-2700K-IP68	
B3528-12V-120-8mm-9.6W-3000K-IP22		B3528-12V-120-8mm-9.6W-3000K-IP68	
B3528-12V-120-8mm-9.6W-3500K-IP22		B3528-12V-120-8mm-9.6W-3500K-IP68	
B3528-12V-120-8mm-9.6W-4200K-IP22		B3528-12V-120-8mm-9.6W-4200K-IP68	
B3528-12V-120-8mm-9.6W-6200K-IP22		B3528-12V-120-8mm-9.6W-6200K-IP68	

### CUSTOM OPTIONS:

SMD TYPE	INPUT VOLTAGE	LED DENSITY	STRIP WIDTH	RATED POWER	CCT	USAGE	LEAD IN / OUT	STRIP LENGTH
<b>B3528</b> - 3.5 x 2.8mm	<b>12V</b> - 12 volt <b>24V</b> - 24 volt	<b>120</b> - 120 LED/m	<b>8mm</b> ( $\frac{5}{16}$ in.)	<b>9.6 W/m</b> (2.9 W/ft)	<input type="checkbox"/> 2700K <input type="checkbox"/> 3000K <input type="checkbox"/> 3500K <input type="checkbox"/> 4200K <input type="checkbox"/> 6200K	<b>IP22</b> - indoor dry location  <b>IP68</b> - wet/damp location	<b>HW3</b> - Hardwire 36" <b>HW6</b> - Hardwire 72" <b>HW9</b> - Hardwire 108" <b>HWX</b> - Hardwire cust. <b>DC3</b> - DC plug 36" <b>DC6</b> - DC plug 72" <b>DC9</b> - DC plug 108" <b>DCX</b> - DC plug cust. <b>NO</b> - No lead	Custom length up to 420 inches.  Quick ship regular roll is 196 inches - 12 in HW only.

<b>B3528</b>	-	<b>120</b>	-	<b>8MM</b>	-	<b>9.6W</b>	-		-		-					
SMD TYPE		INPUT VOLTAGE		LED/M		WIDTH		W/M		CCT		USAGE		IN	OUT	LENGTH

\*NOTE: The light output is provided in lumens per foot, for a CCT of 4200K and a clear lens. Please refer to the optics page for CCT and translucency conversion factors.

# B3528-24V-180-8MM-14.5W-XXK-IPYY

LED Engines



## FEATURES

- Lumen output: 24V = 308 lm/ft
- Single row, SMD 3528
- 54.9 LED/ft / 180 LED/m
- Width:  $\frac{5}{16}$  in / 8mm
- Length: 16.4ft / 5m
- 24V
- 4.4 W/ft / 14.5 W/m



24V LED ENGINE - IP22	QUANTITY	24V LED ENGINE - IP68	QUANTITY
B3528-24V-180-8mm-14.5W-2400K-IP22		B3528-24V-180-8mm-14.5W-2400K-IP68	
B3528-24V-180-8mm-14.5W-2700K-IP22		B3528-24V-180-8mm-14.5W-2700K-IP68	
B3528-24V-180-8mm-14.5W-3000K-IP22		B3528-24V-180-8mm-14.5W-3000K-IP68	
B3528-24V-180-8mm-14.5W-3500K-IP22		B3528-24V-180-8mm-14.5W-3500K-IP68	
B3528-24V-180-8mm-14.5W-4200K-IP22		B3528-24V-180-8mm-14.5W-4200K-IP68	
B3528-24V-180-8mm-14.5W-5300K-IP22		B3528-24V-180-8mm-14.5W-5300K-IP68	

### CUSTOM OPTIONS:

SMD TYPE	INPUT VOLTAGE	LED DENSITY	STRIP WIDTH	RATED POWER	CCT	USAGE	LEAD IN / OUT	STRIP LENGTH	
B3528 - 3.5 x 2.8mm	24V - 24 volt	180 - 180 LED/m	8mm ( $\frac{5}{16}$ in.)	14.5 W/m (4.4 W/ft)	<input type="checkbox"/> 2400K <input type="checkbox"/> 2700K <input type="checkbox"/> 3000K <input type="checkbox"/> 3500K <input type="checkbox"/> 4200K <input type="checkbox"/> 5300K	IP22 - indoor dry location  IP68 - wet/damp location	HW3 - Hardwire 36" HW6 - Hardwire 72" HW9 - Hardwire 108" HWX - Hardwire cust. DC3 - DC plug 36" DC6 - DC plug 72" DC9 - DC plug 108" DCX - DC plug cust. NO - No lead	Custom length up to 420 inches.  Quick ship regular roll is 196 inches - 12 in HW only.	
<b>B3528</b>	<b>24V</b>	<b>180</b>	<b>8MM</b>	<b>14.5W</b>					
SMD TYPE	INPUT VOLTAGE	LED/M	WIDTH	W/M	CCT	USAGE	IN	OUT	LENGTH

\*NOTE: The light output is provided in lumens per foot, for a CCT of 4200K and a clear lens. Please refer to the optics page for CCT and translucency conversion factors.

# B2835-24V-240-10MM-23W-XXK-IPYY-HOS

## LED Engines



### FEATURES

- Lumen output: 24V = 700 lm/ft
- Single row, SMD 2835
- 73 LED/ft / 240 LED/m
- Width: 3/8 in / 10mm
- Length: 16.4ft / 5m
- 24V
- 7 W/ft / 23 W/m
- 113.1 lm/W (5300K)



24V LED ENGINE - IP22	QUANTITY
B2835-24V-240-10mm-23W-2400K-IP22-HOS	LM21423-01
B2835-24V-240-10mm-23W-2700K-IP22-HOS	LM21423-02
B2835-24V-240-10mm-23W-3000K-IP22-HOS	LM21423-03
B2835-24V-240-10mm-23W-3500K-IP22-HOS	LM21423-04
B2835-24V-240-10mm-23W-4200K-IP22-HOS	LM21423-05
B2835-24V-240-10mm-23W-5300K-IP22-HOS	LM21423-06

### CUSTOM OPTIONS:

SMD TYPE	INPUT VOLTAGE	LED DENSITY	STRIP WIDTH	RATED POWER	CCT	USAGE	LEAD IN / OUT	STRIP LENGTH	
B2835 - 2.8 x 3.5mm	24V - 24 volt	240 - 240 LED/m	10mm (3/8 in.)	23W/m (7 W/ft)	<div style="display: flex; flex-direction: column; gap: 5px;"> <div style="display: flex; align-items: center;"><span style="width: 15px; height: 10px; background-color: #f4a460; border: 1px solid black;"></span> 2400K</div> <div style="display: flex; align-items: center;"><span style="width: 15px; height: 10px; background-color: #f9c996; border: 1px solid black;"></span> 2700K</div> <div style="display: flex; align-items: center;"><span style="width: 15px; height: 10px; background-color: #fde725; border: 1px solid black;"></span> 3000K</div> <div style="display: flex; align-items: center;"><span style="width: 15px; height: 10px; background-color: #fff176; border: 1px solid black;"></span> 3500K</div> <div style="display: flex; align-items: center;"><span style="width: 15px; height: 10px; background-color: #fff9c4; border: 1px solid black;"></span> 4200K</div> <div style="display: flex; align-items: center;"><span style="width: 15px; height: 10px; background-color: #fff176; border: 1px solid black;"></span> 5300K</div> </div>	IP22 - indoor dry location	HW3 - Hardwire 36" HW6 - Hardwire 72" HW9 - Hardwire 108" HWX - Hardwire cust. DC3 - DC plug 36" DC6 - DC plug 72" DC9 - DC plug 108" DCX - DC plug cust. NO - No lead	Custom length up to 420 inches.  Quick ship regular roll is 196 inches - 12 in HW only.	
<b>B2835</b>	<b>24V</b>	<b>240</b>	<b>10mm</b>	<b>23W</b>		<b>IP22</b>			
SMD TYPE	INPUT VOLTAGE	LED/M	WIDTH	W/M	CCT	USAGE	IN	OUT	LENGTH

\*NOTE: The light output is provided in lumens per foot, for a CCT of 4200K and a clear lens. Please refer to the optics page for CCT and translucency conversion factors.



# B5050-24V-60-10MM-14.4W-RGB-IPYY

LED Engines



## FEATURES

- Single row, SMD 5050
- 18.3 LED/ft / 60 LED/m
- Width: 3/8 in / 10mm
- Length: 16.4ft / 5m
- 24V
- 4.4 W/ft / 14.4 W/m

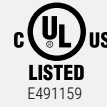

24V LED ENGINE - IP22		QUANTITY	24V LED ENGINE - IP68		QUANTITY
B5050-24V-60-10mm-14.4W-RGB-IP22	LM28336		B5050-24V-60-10mm-14.4W-RGB-IP68	LM28338	

### CUSTOM OPTIONS:

SMD TYPE	INPUT VOLTAGE	LED DENSITY	STRIP WIDTH	RATED POWER	COLOR	USAGE	LEAD IN / OUT	STRIP LENGTH	
B5050 - 5 x 5mm	24V - 24 volt	60 - 60 LED/m	10mm (3/8 in.)	14.4W/m (4.4 W/ft)	 RGB	IP22 - indoor dry location  IP68 - wet/damp location	HW3 - Hardwire 36" HW6 - Hardwire 72" HW9 - Hardwire 108" HWX - Hardwire cust. DC3 - DC plug 36" DC6 - DC plug 72" DC9 - DC plug 108" DCX - DC plug cust. NO - No lead	Custom length up to 420 inches.  Quick ship regular roll is 196 inches - 12 in HW only.	
<b>B5050</b>	<b>24V</b>	<b>60</b>	<b>10MM</b>	<b>14.4W</b>	<b>RGB</b>				
SMD TYPE	INPUT VOLTAGE	LED/M	WIDTH	W/M	RGB / RGBW	USAGE	IN	OUT	LENGTH

# B3535-24V-112-10MM-19.2W-RGB-IPYY

LED Engines

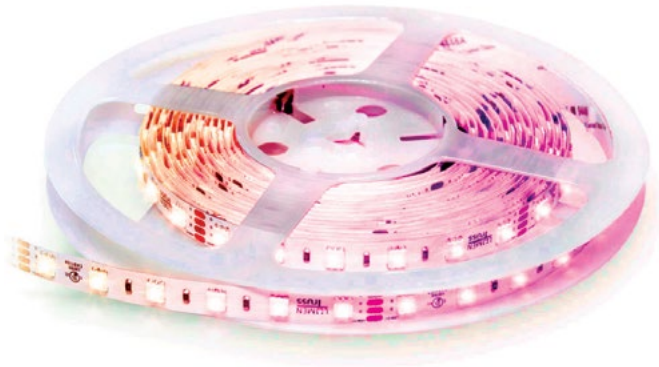

## FEATURES

- Single row, SMD 3535
- 34 LED/ft / 112 LED/m
- Width: 3/8 in / 10mm
- Length: 16.4ft / 5m
- 24V
- 5.9W/ft / 19.2 W/m

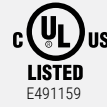

24V LED ENGINE - IP22		QUANTITY	24V LED ENGINE - IP68		QUANTITY
B3535-24V-112-10mm-19.2W-RGB-IP22	LM28335		B3535-24V-112-10mm-19.2W-RGB-IP68	LM28335-01	

### CUSTOM OPTIONS:

SMD TYPE	INPUT VOLTAGE	LED DENSITY	STRIP WIDTH	RATED POWER	COLOR	USAGE	LEAD IN / OUT	STRIP LENGTH	
B3535 - 3.5 x 3.5mm	24V - 24 volt	112 - 112 LED/m	10mm (3/8 in.)	19.2W/m (5.9 W/ft)	 RGB	IP22 - indoor dry location  IP68 - wet/damp location	HW3 - Hardwire 36" HW6 - Hardwire 72" HW9 - Hardwire 108" HWX - Hardwire cust. DC3 - DC plug 36" DC6 - DC plug 72" DC9 - DC plug 108" DCX - DC plug cust. NO - No lead	Custom length up to 420 inches.  Quick ship regular roll is 196 inches - 12 in HW only.	
<b>B3535</b>	<b>24V</b>	<b>112</b>	<b>10MM</b>	<b>19.2W</b>	<b>RGB</b>				
SMD TYPE	INPUT VOLTAGE	LED/M	WIDTH	W/M	RGB / RGBW	USAGE	IN	OUT	LENGTH

# B5050-24V-60-10MM-14.4W-RGB+WHITE-IPYY

LED Engines



## FEATURES

- Single row, SMD 5050
- 18.3 LED/ft / 60 LED/m
- Width: 3/8 in / 10mm
- Length: 16.4ft / 5m
- 24V
- 4.4 W/ft / 14.4 W/m

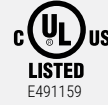

24V LED ENGINE - IP22	QUANTITY	24V LED ENGINE - IP68	QUANTITY
B5050-24V-60-10mm-14.4W-RGB+WHITE-IP22	LM28340-21	B5050-24V-60-10mm-14.4W-RGB+WHITE-IP68	LM28340-11

### CUSTOM OPTIONS:

SMD TYPE	INPUT VOLTAGE	LED DENSITY	STRIP WIDTH	RATED POWER	COLOR	USAGE	LEAD IN / OUT	STRIP LENGTH	
B5050 - 5 x 5mm	24V - 24 volt	60 - 60 LED/m	10mm (3/8 in.)	14.4W/m (4.4 W/ft)	RGBW	IP22 - indoor dry location  IP68 - wet/damp location	HW3 - Hardwire 36" HW6 - Hardwire 72" HW9 - Hardwire 108" HWX - Hardwire cust. DC3 - DC plug 36" DC6 - DC plug 72" DC9 - DC plug 108" DCX - DC plug cust. NO - No lead	Custom length up to 420 inches.  Quick ship regular roll is 196 inches - 12 in HW only.	
<b>B5050</b>	<b>24V</b>	<b>60</b>	<b>10MM</b>	<b>14.4W</b>	<b>RGBW</b>				
SMD TYPE	INPUT VOLTAGE	LED/M	WIDTH	W/M	RGB / RGBW	USAGE	IN	OUT	LENGTH

# TUNABLE WHITE

LED Engines

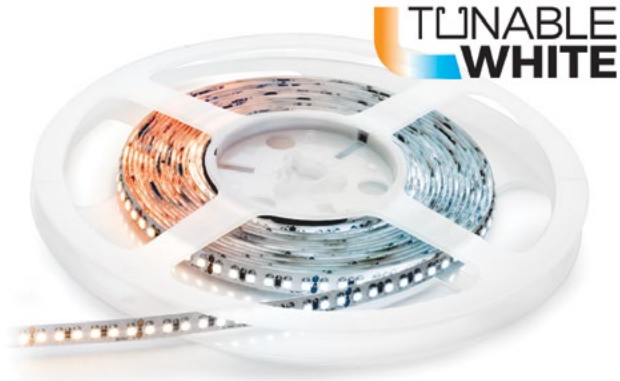

## FEATURES

- LED Linear Density: 72 LED/ft / 240 LED/m
- Strip Width: 3/8 in / 10mm
- Strip Total Length (Roll): 16ft / 5m
- Rated Power (Max.): 6 W/ft / 19.2 W/m
- 24V
- CRI 90+

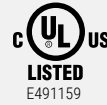

24V LED ENGINE - IP22

QUANTITY

24V LED ENGINE - IP68

QUANTITY

B3528-24V-240-10MM-SINGLE ROW-19.2W-TWHITE-IP22

B3528-24V-240-10MM-SINGLE ROW-19.2W-TWHITE-IP68

### CUSTOM OPTIONS:

SMD TYPE	INPUT VOLTAGE	LED DENSITY	STRIP WIDTH	RATED POWER	COLOR	USAGE	LEAD IN / OUT	STRIP LENGTH	
B3535 - 3.5 x 2.8mm	24V - 24 volt	240 - 240 LED/m	10mm (%in.)	19.2W/m (5.9 W/ft)	 TWHITE	IP22 - indoor dry location  IP68 - wet/damp location	HW3 - Hardwire 36" HW6 - Hardwire 72" HW9 - Hardwire 108"  HWX - Hardwire cust. DC3 - DC plug 36" DC6 - DC plug 72" DC9 - DC plug 108" DCX - DC plug cust. NO - No lead	Custom length up to 420 inches.  Quick ship regular roll is 196 inches - 12 in HW only.	
<b>B3528</b>	<b>24V</b>	<b>240</b>	<b>10MM</b>	<b>19.2W</b>	<b>TWHITE</b>				
SMD TYPE	INPUT VOLTAGE	LED/M	WIDTH	W/M	RGB / RGBW	USAGE	IN	OUT	LENGTH

A modern office interior featuring a prominent yellow ductwork structure on the ceiling, illuminated by long, linear LED light fixtures. The space includes a wooden table with blue and black stools, a yellow wire chair, and a large window with a planter box. A glass-walled office area is visible in the background.

**LEDS**  
TALK ABOUT  
**YOUR**  
PROJECTS

# LUXLINE

## TIRED OF YOUR LED DRIVERS?

No drivers required up to 164 ft.



**YOUR SOLUTION TO LONG LED RUN**

**350 LM/FT**

**LUXLINE DRIVERLESS TECHNOLOGY UP TO 164 LINEAR FT**

### LUXLINE FEATURES

- LumenTruss Driverless technology.
- Direct line voltage.
- Constant current IC providing uniform intensity over the entire run.
- Uses North American power plug with built-in fuse.
- 164 FT maximum run.
- Ultra high lumen output.
- Architectural grade.
- PVC coating (not recommended for direct sunlight).
- IP65 - **(HAS TO BE DONE IN FACTORY OVERMOLDED CONNECTORS)**.
- 3 year warranty - Life of 50,000 hours.
- NOTICE: Do not cut AC plug.

<b>164 Ft MAX</b>	<b>120V</b> Plug & Play or Hardwire	<b>115 LM/W</b>	<b>CUSTOM LENGTHS</b>
	<b>DRIVER</b>		<b>TITLE 20 COMPLIANT</b>

### RECOMMENDED DIMMERS - 3% TO 80%

- Lutron DVELV-300P-LA
- Leviton Sureslide 6674
- Skylark SELV 300P

### PLUG-IN AND HARDWIRE VERSIONS

Plug-in Connection Diagram

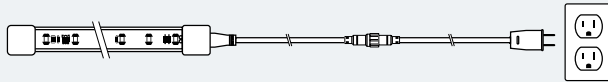

Hardwire Connection Diagram

**NEW revolutionary hardwire connection with built-in fuse! Exclusive to LumenTruss.**



120V LED ENGINE - IP65 - ROLL 164 FT		QTY	ACCESSORIES	QTY	PVC EXTRUSIONS	QTY
B3056-LUXLINE120-72-16MM-13.2W-2400K	LM28500-15		DIY Kit jumper 6"	LM28500-93	LuxSleeve with Prime lens, 8'	LSPR
B3056-LUXLINE120-72-16MM-13.2W-2700K	LM28500-25		DIY Kit jumper 12"	LM28500-94	LuxSleeve with Clear lens, 8'	LSCL
B3056-LUXLINE120-72-16MM-13.2W-3000K	LM28500-35		DIY Kit Plug-In (120cm cable)	LM28500-87		
B3056-LUXLINE120-72-16MM-13.2W-3500K	LM28500-40		DIY Kit Hardwire	LM28500-86		
B3056-LUXLINE120-72-16MM-13.2W-4000K	LM28500-45		Bracket (suggested every 6")	LM28500-92		

### CUSTOM OPTIONS:

SMD TYPE	INPUT VOLTAGE	LED DENSITY	STRIP WIDTH	RATED POWER	CCT	JUMPER	LEAD IN / OUT	STRIP LENGTH
B3056 - 3 x 5.6mm	120 - 120 volt	72 - 72 LED/m	16mm (% in.)	13.2W/m (4 W/ft)		JP6 - Jumper 6" JP12 - Jumper 12" NO - No jumper	PG - Plug-in 47" HW - Hardwire 118"	Order in lengths of 1ft (12in.)* *Connection every 12 inches, cuttable every 12 in.
<b>B3056</b>	<b>LUXLINE120</b>	<b>72</b>	<b>16mm</b>	<b>13.2W</b>	CCT	JUMPER	IN OUT	LENGTH

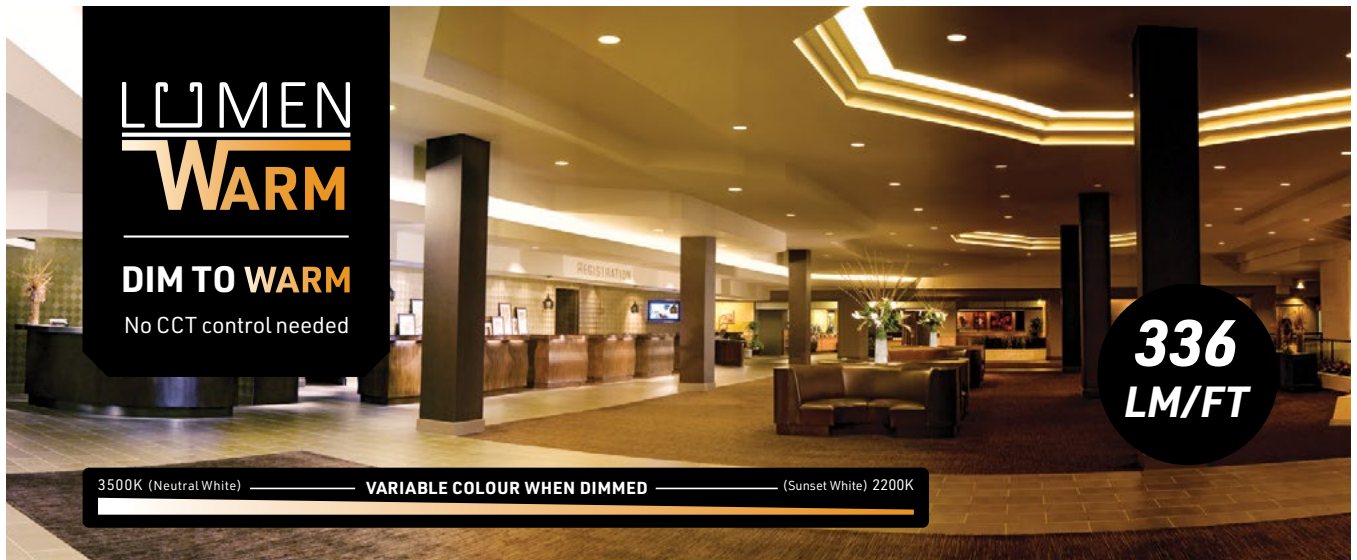

### WARMDIM FEATURES

- Dim to warm, variable colour when dimmed.
- A different mood for different times of the day
- No CCT control needed.
- Cuttable every 2.46 inches (14 LEDs).
- 3M double sided tape for easy installation.
- Compatible with PWM controller (PWM is a powerful technique for controlling analog circuits with a microprocessor's digital outputs).



24V LED ENGINE - IP22 - ROLL 16.4 FT	QUANTITY	24V LED ENGINE - IP67 - ROLL 16.4 FT	QUANTITY
B2016-24V-224-12mm-17.3W-WARMDIM-2200-3500K-IP22 LM28500		B2016-24V-224-12mm-17.3W-WARMDIM-2200-3500K-IP67 LM28500-01	
B2016-24V-240-10mm-14.5W-WARMDIM-2200-2900K-IP22		B2016-24V-240-10mm-14.5W-WARMDIM-2200-2900K-IP67	

#### CUSTOM OPTIONS:

SMD TYPE	INPUT VOLTAGE	LED DENSITY	STRIP WIDTH	RATED POWER	CCT	USAGE	LEAD IN / OUT	STRIP LENGTH
B2016 - 2 x 1.6mm	24V - 24 volt	224 - 224 LED/m → 12mm (½ in.) → 17.3W/m (5.3 W/ft) → 2200-3500K	12mm (½ in.)	17.3W/m (5.3 W/ft)	2200-3500K	IP22 - indoor dry location	HW3 - Hardwire 36" HW6 - Hardwire 72" HW9 - Hardwire 108" HWX - Hardwire cust. DC3 - DC plug 36" DC6 - DC plug 72" DC9 - DC plug 108" DCX - DC plug cust. NO - No lead	Custom length up to 420 inches.
		240 - 240 LED/m → 10mm (¾ in.) → 14.5W/m (4.4 W/ft) → 2200-2900K						

B2016

24V

SMD TYPE
INPUT VOLTAGE
LED/M
WIDTH
W/M
CCT
USAGE
IN
OUT
LENGTH

LED ENGINE

# NEON SLEEVE SERIES

Highly durable, flexible,  
Uniform pixel free light!

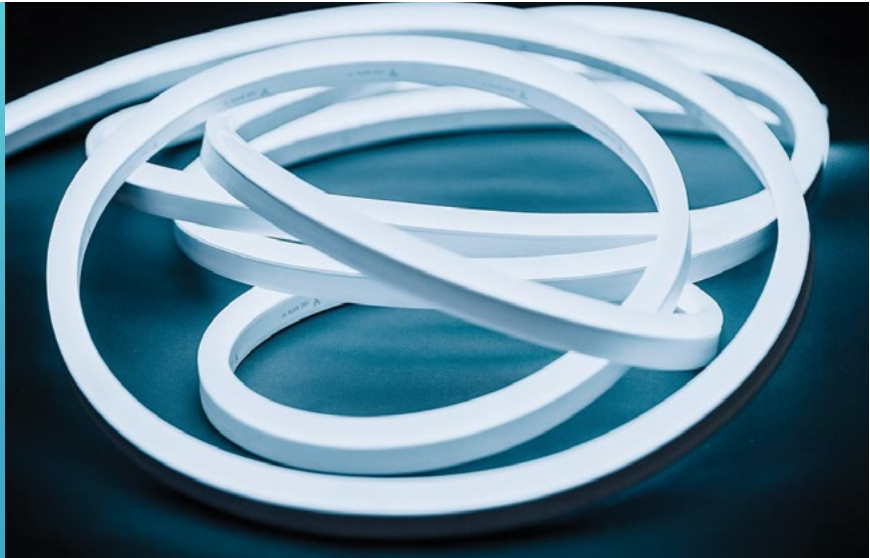

## NEON SLEEVES FEATURES

- Attractive modern look for wide variety of applications.
- Silicone material, resistant to yellowing and high temperature, can be used outdoors.
- Soft, flexible.
- Easy modeling and tensile resistance.
- Professional structure design.
- Uniform light, no spots.
- Consistent color temperature.

## COMPATIBLE WITH

**Color Temperature:**  
2400K, 2700K, 3000K, 3500K, 4200K, 6200K

**Lumen Package:**  
LP0: 128 LM / 1.5W FT / 90+CRI  
LP1: 160 LM / 1.5W FT / 90+CRI  
LP2: 255 LM / 3.0W FT / 90+CRI  
LP3: 308 LM / 4.5W FT / 90+CRI  
LP4: 400 LM / 5.8W FT / 90+CRI  
LHP: 700LM / 7.0W FT / 95+ CRI

## FIVE DIFFERENT MODELS

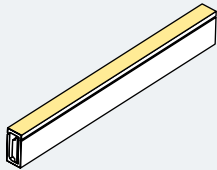

Mini Side Flex

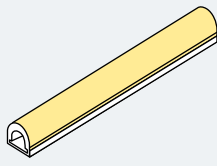

180 Flex

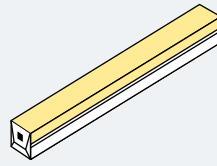

3D Flex

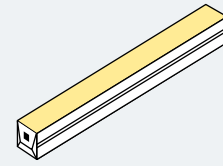

Top View Flex

SLEEVE TYPE	BRACKET	LENGTH	CCT	LUMEN PACKAGE	LEAD IN / OUT	USAGE	POWER SUPPLY TYPE
MSF - Mini Side Flex TOPF - Top View Flex 3DF - 3D Flex 180F - 180 Flex	FL - Flat bracket	<b>Total length in inches</b> Max. length = 196in (5m) per driver	<div style="display: flex; flex-direction: column; gap: 5px;"> <div><span style="display: inline-block; width: 15px; height: 10px; background-color: #f4a460; border: 1px solid black;"></span> 24 - 2400K</div> <div><span style="display: inline-block; width: 15px; height: 10px; background-color: #f4c996; border: 1px solid black;"></span> 27 - 2700K</div> <div><span style="display: inline-block; width: 15px; height: 10px; background-color: #f4e1d9; border: 1px solid black;"></span> 30 - 3000K</div> <div><span style="display: inline-block; width: 15px; height: 10px; background-color: #f4f2e1; border: 1px solid black;"></span> 35 - 3500K</div> <div><span style="display: inline-block; width: 15px; height: 10px; background-color: #f4f9e1; border: 1px solid black;"></span> 42 - 4200K</div> <div><span style="display: inline-block; width: 15px; height: 10px; background-color: #f4f9e1; border: 1px solid black;"></span> 53 - 5300K</div> <div><span style="display: inline-block; width: 15px; height: 10px; background-color: #f4f9e1; border: 1px solid black;"></span> 62 - 6200K</div> <div><span style="display: inline-block; width: 15px; height: 10px; background-color: #f4f9e1; border: 1px solid black;"></span> WD - WarmDim</div> <div><span style="display: inline-block; width: 15px; height: 10px; background-color: #f4f9e1; border: 1px solid black;"></span> TW - Tunable White</div> <div><span style="display: inline-block; width: 15px; height: 10px; background-color: #f4f9e1; border: 1px solid black;"></span> RGB - RGB</div> <div><span style="display: inline-block; width: 15px; height: 10px; background-color: #f4f9e1; border: 1px solid black;"></span> RGBW - RGBW</div> </div> <p><b>Note:</b> Warmdim, Tunable White &amp; RGBW options are only available with TOPF sleeve.</p>	<p>LP0 - 128 LM/1.5W FT/90+CRI LP1 - 160 LM/1.5W FT/90+CRI LP2 - 255 LM/3.0W FT/90+CRI LP3 - 308 LM/4.5W FT/90+CRI LP4 - 400 LM/5.8W FT/90+CRI LHP - 700 LM/7.0W FT/95+CRI</p> <p><b>Note:</b> Not applicable for Warmdim, Tunable White &amp; RGB color temperatures</p> <p>LP4 and LHP Lumen Package options are only available with TOPF sleeve.</p>	<p>HW3F - Hardwire 3ft, front HW3S - Hardwire 3ft, side HW6F - Hardwire 6ft, front HW6S - Hardwire 6ft, side HW9F - Hardwire 9ft, front HW9S - Hardwire 9ft, side HWXF - Hardwire N ft, front HWXS - Hardwire N ft, side DC3F - DC plug 3ft, front DC3S - DC plug 3ft, side DC6F - DC plug 6ft, front DC6S - DC plug 6ft, side DC9F - DC plug 9ft, front DC9S - DC plug 9ft, side DCXF - DC plug N ft, front DCXS - DC plug N ft, side</p>	<p>I - IP65 dry and damp locations</p>	<p>A - No dimming B - ELV dimming 120VAC C - ELV dimming 120/277VAC D - 0/10V dimming 120/277VAC E - No dimming DC plug in NO - No driver</p>
	FL					I	
SLEEVE TYPE	MOUNTING HARDWARE	LENGTH	COLOUR TEMPERATURE	LUMEN PACKAGE	LEAD IN LEAD OUT	USAGE	POWER SUPPLY TYPE

\*NOTE: The light output is provided in lumens per foot, for a CCT of 4200K and a clear lens. Please refer to the optics page for CCT and translucency conversion factors



LED ENGINE

# NEON FLEX

Fully dimmable, highly durable, flexible & pixel free



The Neon Flex Topview is designed for indoor architectural projects in commercial installations such as shopping centres, hotels, restaurants and many other applications. Side view can be flexed "up & down" with a maximum radius of 5 in.

## NEON FLEX FEATURES





- Forward Voltage 24VDC
- Forward Current 183mA/ft
- LED Density 73 LED/ft
- Power <4.4W/ft
- Width 0.375 in
- Thickness 0.375 in
- Length 196 in (16.4 ft)
- Min. Bending Diameter 5 in
- Can Be Cut Anywhere
- IP Grade IP65
- CRI 90+



### NEON SLEEVE

NF - Neon Flex

### COLOR TEMPERATURE

-  24 - 2400K
-  27 - 2700K
-  30 - 3000K
-  35 - 3500K

### LENGTH

Total length in inches

NF

NEON FLEX

COLOR TEMPERATURE CCT

LENGTH (inches)

# POWER SUPPLIES

**Lighting under control!** Our comprehensive range of power supplies includes **dimnable electronic drivers**, compatible with most ELV (Triac / forward phase / reverse phase) or 0-10V dimmers. Used directly on standard 120VAC input, they are available in **constant voltage** output (12VDC or 24VDC) for common LED light sources, also in **constant current** output for special applications. Many power supplies are available in **custom junction boxes** for extra protection and superior lifespan. Featured below is a selection of our most popular products in constant voltage output.



## 12V DIMMABLE DRIVERS IN JUNCTION BOXES























Product code	LTPS-DIM-100 130VAC-CV-12V-25W-ELV-HW-DRBX	LTPS-DIM-100 130VAC-CV-12V-50W-ELV-HW-DRBX	LTPS-DIM-100 130VAC-CV-12V-120W-ELV-HW-IP67-DRBX	LTPS-DIM-100 130VAC-CV-12V-200W-ELV-HW-IP67-DRBX
Input Type	<b>Hardwire</b>	<b>Hardwire</b>	<b>Hardwire</b>	<b>Hardwire</b>
Input Voltage	100-130VAC	100-130VAC	100-130VAC	100-130VAC
Output Voltage	<b>12VDC</b>	<b>12VDC</b>	<b>12VDC</b>	<b>12VDC</b>
Rated Power (max.)	<b>25W</b>	<b>50W</b>	<b>120W</b>	<b>200W</b>
IP Rating	<b>IP20</b>	<b>IP20</b>	<b>IP67</b>	<b>IP67</b>
Dimming				
IEC Protection	<b>Class 2</b>	<b>Class 2</b>	<b>Class 1</b>	<b>Class 1</b>
Ground Class				
Certification	 CUL US LISTED E309419 CIP-CV-121F	 CUL US LISTED E309401 CHP-CV-121T	 CUL US LISTED E341221 CHP-CV-120T	 CUL US LISTED E341271 CHP-CV-121X

## 12V NON-DIMMABLE DRIVERS























Product code	PS-CV-120-24-1000mA-24W-WH-PG	PS-CV-120-12-5000mA-60W-BK-DK	LTPS-VS-12VDC-60W-IP65-HW	LTPS-IPS-12VDC-60W-IP66-HW	LTPS-IPS-12VDC-100W-IP66-HW	LTPS-IPS-12VDC-200W-IP66-HW
Input Type	<b>Plug-in</b>	<b>Plug-in, desktop</b>	<b>Hardwire</b>	<b>Hardwire</b>	<b>Hardwire</b>	<b>Hardwire</b>
Input Voltage	100-240VAC	100-240VAC	100-240VAC	100-277VAC	100-277VAC	100-277VAC
Output Voltage	<b>12VDC</b>	<b>12VDC</b>	<b>12VDC</b>	<b>12VDC</b>	<b>12VDC</b>	<b>12VDC</b>
Rated Power (max.)	<b>24W</b>	<b>60W</b>	<b>60W</b>	<b>60W</b>	<b>100W</b>	<b>200W</b>
IP Rating	<b>IP22</b>	<b>IP22</b>	<b>IP65</b>	<b>IP66</b>	<b>IP66</b>	<b>IP66</b>
Dimming						
IEC Protection	<b>Class 2</b>	<b>Class 2</b>	<b>Class 2</b>	<b>Class 2</b>	<b>Class 1</b>	<b>Class 1</b>
Ground Class						
Certification	 CUL US LISTED E309419 XY243-12020000-UW	 CUL US LISTED E309404 XY605-12050000-UD	 CUL US LISTED E340001 LD060C-CU50012-40	 CUL US LISTED E341221 VF-1206001310	 CUL US LISTED E341271 VF-12100002-42	 CUL US LISTED E341271 VD-1220000710

## 24V DIMMABLE DRIVERS IN JUNCTION BOXES





					
Product code	LTPS-DIM-100 130VAC-CV-24V-25W-ELV-EN-DRBX	LTPS-DIM-100 130VAC-CV-24V-50W-ELV-HW-DRBX	LTPS-DIM-100 130VAC-CV-24V-96W-ELV-HW-IP67-DRBX	TFT-DIM-PS-100 130VAC-CV-24V-200W-ELV-HW-IP67-DRBX (LM42496-05)	LTPS-DIM-110 277VAC-CV-24V-100W-0-10V-IP66-DRBX
Input Type	<b>Hardwire</b>	<b>Hardwire</b>	<b>Hardwire</b>	<b>Hardwire</b>	<b>Hardwire</b>
Input Voltage	100-130VAC	100-130VAC	100-130VAC	100-130VAC	100-277VAC
Output Voltage	<b>24VDC</b>	<b>24VDC</b>	<b>24VDC</b>	<b>24VDC</b>	<b>24VDC</b>
Rated Power (max.)	<b>25W</b>	<b>50W</b>	<b>96W</b>	<b>200W</b>	<b>100W</b>
IP Rating	<b>IP20</b>	<b>IP20</b>	<b>IP67</b>	<b>IP67</b>	<b>IP66</b>
Dimming					
IEC Protection	<b>Class 2</b>	<b>Class 2</b>	<b>Class 2</b>	<b>Class 1</b>	<b>Class 2</b>
Ground Class					
Certification					





## 24V NON-DIMMABLE DRIVERS

					
Product code	PS-CV-120-24-2500mA-60W-WH-DK	LTPS-IPS-24VDC-60W-IP66-HW	PS-CV-120-24-4A-96W-BK-DK	LTPS-IPS-24VDC-96W-IP66-HW	LTPS-IPS-24VDC-200W-IP66-HW
Input Type	<b>Plug-in, desktop</b>	<b>Hardwire</b>	<b>Plug-in, desktop</b>	<b>Hardwire</b>	<b>Hardwire</b>
Input Voltage	100-240VAC	100-277VAC	100-240VAC	100-277VAC	100-277VAC
Output Voltage	<b>24VDC</b>	<b>24VDC</b>	<b>24VDC</b>	<b>24VDC</b>	<b>24VDC</b>
Rated Power (max.)	<b>60W</b>	<b>60W</b>	<b>96W</b>	<b>96W</b>	<b>200W</b>
IP Rating	<b>IP22</b>	<b>IP66</b>	<b>IP22</b>	<b>IP66</b>	<b>IP66</b>
Dimming					
IEC Protection	<b>Class 2</b>	<b>Class 2</b>	<b>Class 2</b>	<b>Class 2</b>	<b>Class 1</b>
Ground Class					
Certification					

POWER SUPPLY / PRODUCT CODE

QUANTITY

-  Certified by UL (Underwriters Laboratories) for Canada and the United States concerning North American safety and electrical standards governing this product.
-  Components recognized by UL (Underwriters Laboratories).
-  Product tested by Intertek and found in compliance with accepted national standards.
-  Manufacturer statement of product compliance with relevant European Union directives and standards.
-  Restriction of hazardous materials in electronic and electrical equipment.

-  Can be used with electronic low voltage (ELV), TRIAC, forward-phase and reverse-phase dimmers.
-  Can be used with 0-10V dimmers.
-  Cannot be used with dimmers.
-  Ground Class 1
-  Ground Class 2

HIGH EFFICIENCY  
REFLECTOR

# NEW! HER

Significantly improves  
luminous efficiency!

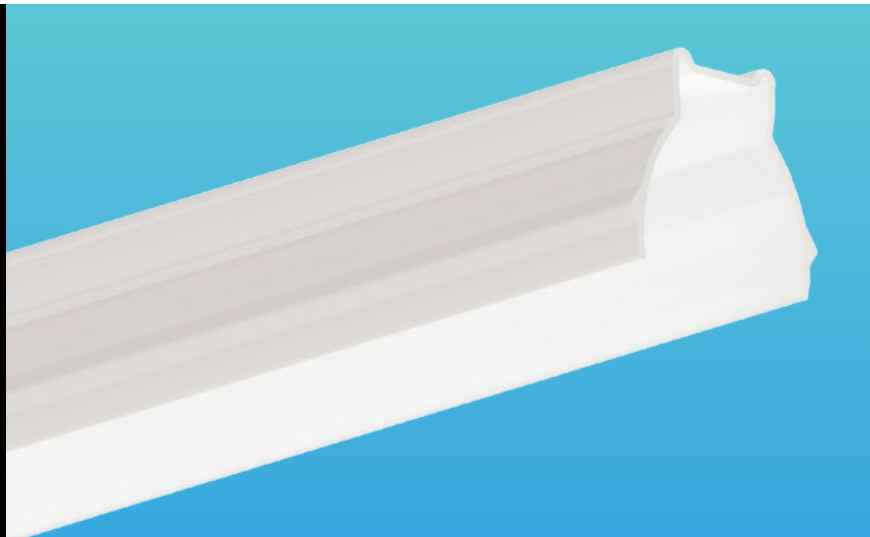

## HER - HIGH EFFICIENCY REFLECTOR

Achieve maximum luminous flux with the **HER** (High Efficiency Reflector)! With its engineered design, this new reflector significantly improves luminous efficiency and provides lighting without loss of light. An ingenious idea that surpasses the use of white reflective paint to maximize lighting.

Even better, the LuxLine 120 V light source fits perfectly at the base of the reflector: forget about 3M foam tape or clips to hold it in place: it fits like a glove! The HER reflector is suitable for **1450, 8500, 8600, 8800 and 9400 series** aluminum profiles.

LUMENSENS

# MOTION SENSOR

30 sec. and 4 min. options.  
Compatible with 1200, 1300,  
1400, 1500, 1650 & 1690.



Turns on automatically when it detects your presence and regulates the amount of light in case of absence. Internal and external installation options available.

Compatible with series: 1200 / 1300 / 1400 / 1500 / 1650 / 1690

## RANGE OF PRODUCTS

Integrated Motion Sensor **30 sec.:** LM16000-5  
Integrated Motion Sensor **4 min.:** LM16000-15

Remote Motion Sensor **30 sec.:** LM16000-20  
Remote Motion Sensor **4 min.:** LM16000-24

# DEMO BOXES

**New!** We now offer demo boxes with samples of our products. Aluminum profiles, recessed and LED light sources are available free of charge\*. To order your demo box, please check the product box and send us your request by fax or email. To order products, please contact your authorized representative or agent.

\* Taxes payable where applicable / U.S. and Canada only.



## KEYCHAIN - DEMO BOX

### INCLUDED

- 1450 Profile - Prime lens
- 1201 Profile - Optiflex lens
- Power supply 24V - 24W
- 1100 Profile - Opal lens
- 1201 Profile - Optiflex lens
- 1300 Profile - Optiflex lens
- 1400 Profile - Prime lens
- 1450 Profile - Prime lens
- 1650 Profile - Opal lens
- 1690 Profile - Opal lens
- 2000 Profile - Opal lens
- 3100 Profile - Prime lens
- 4400 Profile - Optiflex lens
- 4500 Profile - Clear lens
- 5300 Profile - Opal lens
- 7850 Profile - Opal lens
- 8800 Profile - Prime lens

KEYCHAIN DEMO BOX

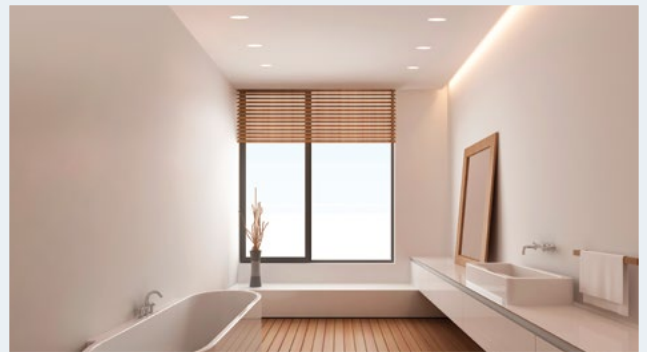

## OMEGA - DEMO BOX

### INCLUDED

- Omega Module
- Trim Square Adjustable - White
- Trim Round Adjustable - White
- Beam 60 degrees, Beam 36 degrees & Beam 22 degrees
- Power Supply 6W
- Suction cup

OMEGA DEMO BOX



## LUXLINE - DEMO BOX

### INCLUDED

- LuxLine LED Strip + AC Plug (38")
- LuxLine120 - DIY Kit Plug-in (47")
- LuxLine120 - DIY Kit Hardwire (40")
- Series 1450 Profile Alu, 6.75"
  - + Series 1450 Prime Lens, 6.75"
  - + Series 1450 Clip PVC (x2)
- LuxLine120-Bracket (x4)

LUXLINE DEMO BOX

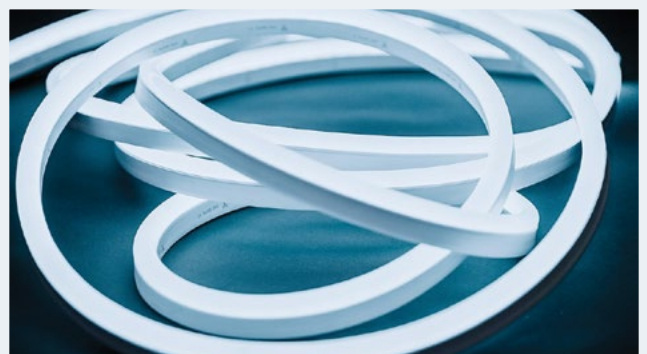

## NEON SLEEVES - DEMO BOX

### INCLUDED

- 360 Flex 16": 14.5W - 4200K
- 180 Flex 9"
- 3D Flex 9"
- Mini Side Flex 9"
- Top View Flex 9"
- Power Supply: 24V - 24W
- Top View Endcaps + Clips
- Lumentruss Badges

NEON SLEEVES DEMO BOX

# APPENDIX

## APPENDIX 1 - RAL COLOR №

RAL is a color matching system which defines colors for paint, coatings and plastics. RAL Classic is the most famous and widely used system. The colors are used in architecture, construction, industry and road safety. When choosing a custom profile color, you must then provide a RAL color №. Please refer to the following website to choose a color and its matching RAL number:

[www.ralcolor.com](http://www.ralcolor.com)

### Example

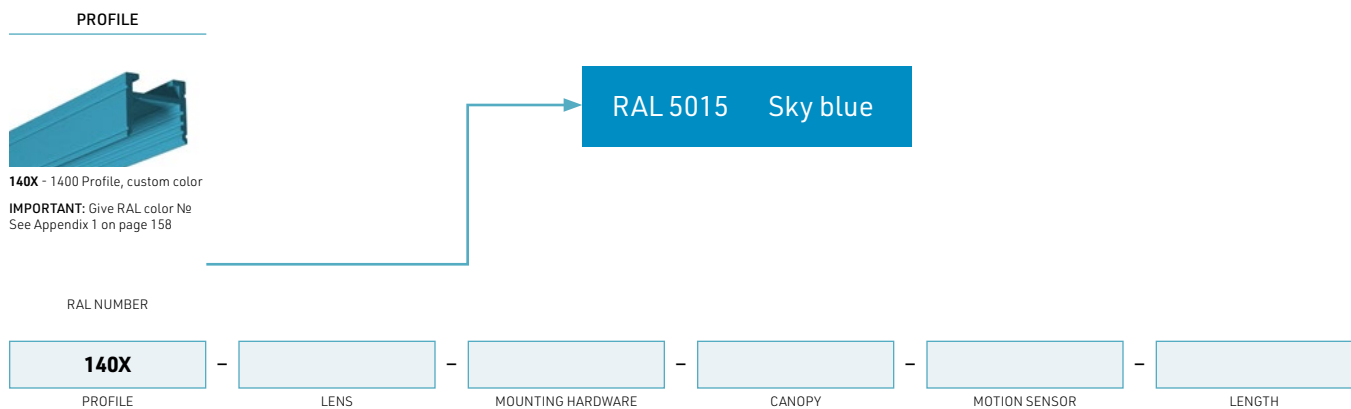

## APPENDIX 2 - CANOPY OPTIONS

Canopy installation options:



### Remote driver canopy plate

The driver is installed in a remote location and then secondary power is fed to a junction box, comes with a 4-inch canopy cover.



### Integrated driver in canopy

The driver is installed inside a rectangle canopy that can be installed to an electrical junction box. Size may vary according to driver.



### Integrated driver & suspension kit

The driver is installed into the canopy and the suspension kit are installed onto the canopy cover, that in turn is connected to a junction box.

## APPENDIX 3 - HOW TO CALCULATE HOW MANY SECTIONS OF 8 FEET TO ORDER

Some products are only available in straight section of 8 feet (96 inches), namely the 3100, 8860, 8900 and the whole Gypsum Series. Here's an example on how to calculate how many sections to order:

### Example

■ Walls    ■ Profiles

$$192 + 120 + 67 + 86 + 125 = 590 \text{ in}$$

$$590 \div 96 = 6.15$$

6.15 rounded up = **7 sections total**



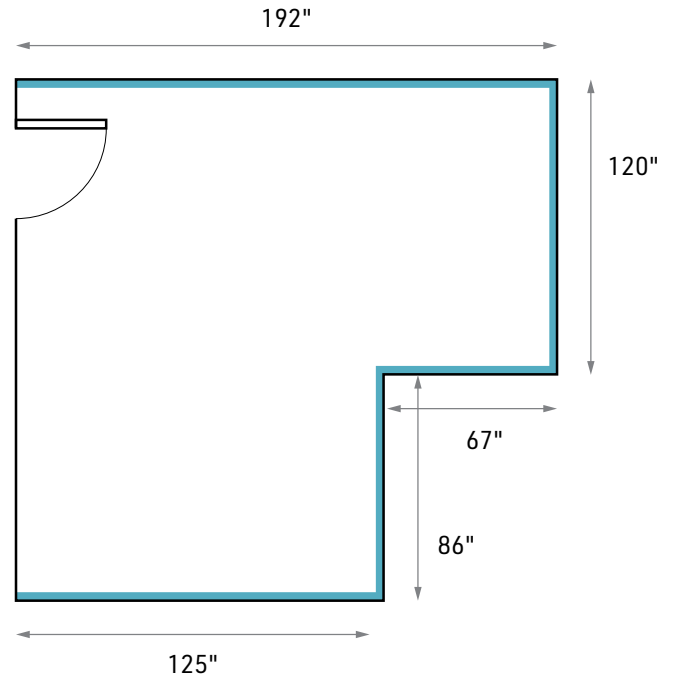





PROFILE	LENGTH
	Available in straight section of 8 feet (96 inches/2.4 m). *Cut on site
<b>7</b> QUANTITY	<b>96 INCHES</b> LENGTH



## HOW TO CALCULATE TOTAL LED ENGINE ORDERING LENGTH

Those same products only available in straight section of 8 feet will not have the LED engine preinstalled. For these profiles where the LED engine will be assembled on site, you need to specify the length when ordering.

**Order each length separately: 192 + 120 + 67 + 86 + 125**

COLOR TEMPERATURE	LUMEN PACKAGE*	LEAD IN/OUT	USAGE	POWER SUPPLY/CONTROL	LENGTH	
 24 - 2400K	LP0 - 128 LM / 1.5W FT / 90+CRI	HW3 - Hardwire 3 FT	I - IP22 indoor dry location	A - Non-dimming	<b>Total length of LED engine in inches</b> - See Appendix 3 on how to calculate length.	
 27 - 2700K	LP1 - 160 LM / 1.5W FT / 90+CRI	HW6 - Hardwire 6 FT		B - ELV dimming 120V AC		
 30 - 3000K	LP2 - 255 LM / 3.0W FT / 90+CRI	HW9 - Hardwire 9 FT		C - ELV dimming 120/277V AC		
 35 - 3500K	LP3 - 308 LM / 4.5W FT / 90+CRI	HWX - Hardwire custom FT		D - 0/10V dimming 120/277V AC		
 42 - 4200K	LHP - 700 LM / 7.0W FT / 95+CRI	DC3 - DC plug 3 FT		E - Non-dimming DC plug in		
 53 - 5300K (LHP only)	Note: Not applicable for WarmDim & RGB color temperatures	DC6 - DC plug 6 FT		F - DMX		
 62 - 6200K (LP only)		DC9 - DC plug 9 FT		NO - No driver		
 RGB - RGB		DCX - DC plug custom FT				
 RGBW - RGBW		NO - No lead				
						<b>192"</b>
COLOR TEMPERATURE CCT	LUMEN PACKAGE	LEAD IN    LEAD OUT	USAGE	POWER SUPPLY/CONTROL		LED ENGINE LENGTH

\*NOTE: The light output is provided in lumens per foot, for a CCT of 4200K and a clear lens. Please refer to the optics page for CCT and translucency conversion factors.

# APPENDIX

## APPENDIX 5 - BRACKET CHART

PROFILE	2 BRACKETS	4 BRACKETS	6 BRACKETS	8 BRACKETS	10 BRACKETS	11 BRACKETS	12 BRACKETS
1100	1-36	37-108	109-180	181-240	-----	-----	-----
1200	1-36	37-108	109-180	181-240	-----	-----	-----
1400	1-36	37-108	109-180	181-240	-----	-----	-----
1500	1-36	25-72	109-180	181-240	-----	-----	-----
1650	RED DOUBLE FACE TAPE 10MM(ROLL 33 METERS) (1033) LM21027-22						
1690	0-24	37-108	73-120	121-168	169-192	193-216	214-240
1800	1-36	37-108	109-180	181-240	-----	-----	-----
2000	1-36	37-108	109-180	181-240	-----	-----	-----
2100	1-36	37-108	109-180	181-240	-----	-----	-----
4400	1-36	37-108	109-180	181-240	-----	-----	-----
4500	1-36	37-108	109-180	181-240	-----	-----	-----
7650	1-36	37-108	109-180	181-240	-----	-----	-----
7800	1-36	37-108	109-180	181-240	-----	-----	-----
7850	1-36	37-108	109-180	181-240	-----	-----	-----
9200	1-36	37-108	109-180	181-240	-----	-----	-----
9400	1-36	37-108	109-180	181-240	-----	-----	-----
9500	0-24	25-72	73-120	121-168	169-192	193-216	217-240

HEAT SINK	2 BRACKETS	3 BRACKETS	4 BRACKETS	5 BRACKETS	6 BRACKETS	7 BRACKETS	9 BRACKETS	10 BRACKETS	11 BRACKETS	12 BRACKETS
9499I	1-36	37-108	109-180	181-240	-----	-----	-----			
9800I	1-36	37-108	109-180	181-240	-----	-----	-----			

## APPENDIX 6 - VOLTAGE DROP CHART

Voltage Drop for 12 VDC for 1.5W / Foot LED Tape				Voltage Drop for 24 VDC for 1.5W / Foot LED Tape				Voltage Drop for 24 VDC for 2.9W / Foot LED Tape				Voltage Drop for 24 VDC for 4.4W / Foot LED Tape			
Dist.	18AWG	20AWG	22AWG	Dist.	18AWG	20AWG	22AWG	Dist.	18AWG	20AWG	22AWG	Dist.	18AWG	20AWG	22AWG
5 ft.	11.87 V	11.80 V	11.68 V	5 ft.	11.93 V	11.90 V	11.84 V	5 ft.	23.87 V	23.80 V	23.68 V	5 ft.	23.81 V	23.70 V	23.52 V
10 ft.	11.74 V	11.59 V	11.35 V	10 ft.	11.87 V	11.80 V	11.68 V	10 ft.	23.74 V	23.59 V	23.35 V	10 ft.	23.62 V	23.39 V	23.03 V
15 ft.	11.62 V	11.39 V	11.03 V	15 ft.	11.81 V	11.70 V	11.52 V	15 ft.	23.62 V	23.39 V	23.03 V	15 ft.	23.43 V	23.09 V	22.55 V
20 ft.	11.49 V	11.19 V	10.71 V	20 ft.	11.74 V	11.59 V	11.35 V	20 ft.	23.49 V	23.19 V	22.71 V	20 ft.	23.23 V	22.78 V	22.06 V
25 ft.	11.36 V	10.98 V	10.39 V	25 ft.	11.68 V	11.49 V	11.19 V	25 ft.	23.36 V	22.98 V	22.39 V	25 ft.	23.04 V	22.48 V	21.58 V
30 ft.	11.23 V	10.78 V	10.06 V	30 ft.	11.62 V	11.39 V	11.03 V	30 ft.	23.23 V	22.78 V	22.06 V	30 ft.	22.85 V	22.17 V	21.09 V
35 ft.	11.11 V	10.58 V	9.74 V	35 ft.	11.55 V	11.29 V	10.87 V	35 ft.	23.11 V	22.58 V	21.74 V	35 ft.	22.66 V	21.87 V	20.61 V
40 ft.	10.98 V	10.38 V	9.42 V	40 ft.	11.49 V	11.19 V	10.71 V	40 ft.	22.98 V	22.38 V	21.42 V	40 ft.	22.47 V	21.56 V	20.13 V
45 ft.	10.85 V	10.17 V	9.09 V	45 ft.	11.43 V	11.09 V	10.55 V	45 ft.	22.85 V	22.17 V	21.09 V	45 ft.	22.28 V	21.26 V	19.64 V
50 ft.	10.72 V	9.97 V	8.77 V	50 ft.	11.36 V	10.98 V	10.39 V	50 ft.	22.72 V	21.97 V	20.77 V	50 ft.	22.08 V	20.95 V	19.16 V
55 ft.	10.60 V	9.77 V	8.45 V	55 ft.	11.30 V	10.88 V	10.22 V	55 ft.	22.60 V	21.77 V	20.45 V	55 ft.	21.89 V	20.65 V	18.67 V
60 ft.	10.47 V	9.56 V	8.13 V	60 ft.	11.23 V	10.78 V	10.06 V	60 ft.	22.47 V	21.56 V	20.13 V	60 ft.	21.70 V	20.34 V	18.19 V
65 ft.	10.34 V	9.36 V	7.80 V	65 ft.	11.17 V	10.68 V	9.90 V	65 ft.	22.34 V	21.36 V	19.80 V	65 ft.	21.51 V	20.04 V	17.70 V
70 ft.	10.21 V	9.16 V	7.48 V	70 ft.	11.11 V	10.58 V	9.74 V	70 ft.	22.21 V	21.16 V	19.48 V	70 ft.	21.32 V	19.74 V	17.22 V
75 ft.	10.08 V	8.95 V	7.16 V	75 ft.	11.04 V	10.48 V	9.58 V	75 ft.	22.08 V	20.95 V	19.16 V	75 ft.	21.13 V	19.43 V	16.74 V
80 ft.	9.96 V	8.75 V	6.83 V	80 ft.	10.98 V	10.38 V	9.42 V	80 ft.	21.96 V	20.75 V	18.83 V	80 ft.	20.93 V	19.13 V	16.25 V
85 ft.	9.83 V	8.55 V	6.51 V	85 ft.	10.91 V	10.27 V	9.26 V	85 ft.	21.83 V	20.55 V	18.51 V	85 ft.	20.74 V	18.82 V	15.77 V
90 ft.	9.70 V	8.34 V	6.19 V	90 ft.	10.85 V	10.17 V	9.09 V	90 ft.	21.70 V	20.34 V	18.19 V	90 ft.	20.55 V	18.52 V	15.28 V
95 ft.	9.57 V	8.14 V	5.87 V	95 ft.	10.78 V	10.07 V	8.93 V	95 ft.	21.57 V	20.14 V	17.87 V	95 ft.	20.36 V	18.21 V	14.80 V
100 ft.	9.45 V	7.94 V	5.54 V	100 ft.	10.67 V	9.97 V	8.77 V	100 ft.	21.45 V	19.94 V	17.54 V	100 ft.	20.17 V	17.95 V	14.31 V

### PHOTO CREDITS

**Maxime Brodeur:** Cover, Inside front cover, pp. 2-3, pp. 8-9, p. 12, p. 20 (right), p. 50 (left), pp. 72-73, p. 78 (left), p. 80 (right), p. 86 (left), pp. 130-131, pp. 136, 137, 138, Back cover.

**Maxime Brouillet:** p. 64 (left), pp. 84-85, p. 86 (right), p. 149.



# NOTES

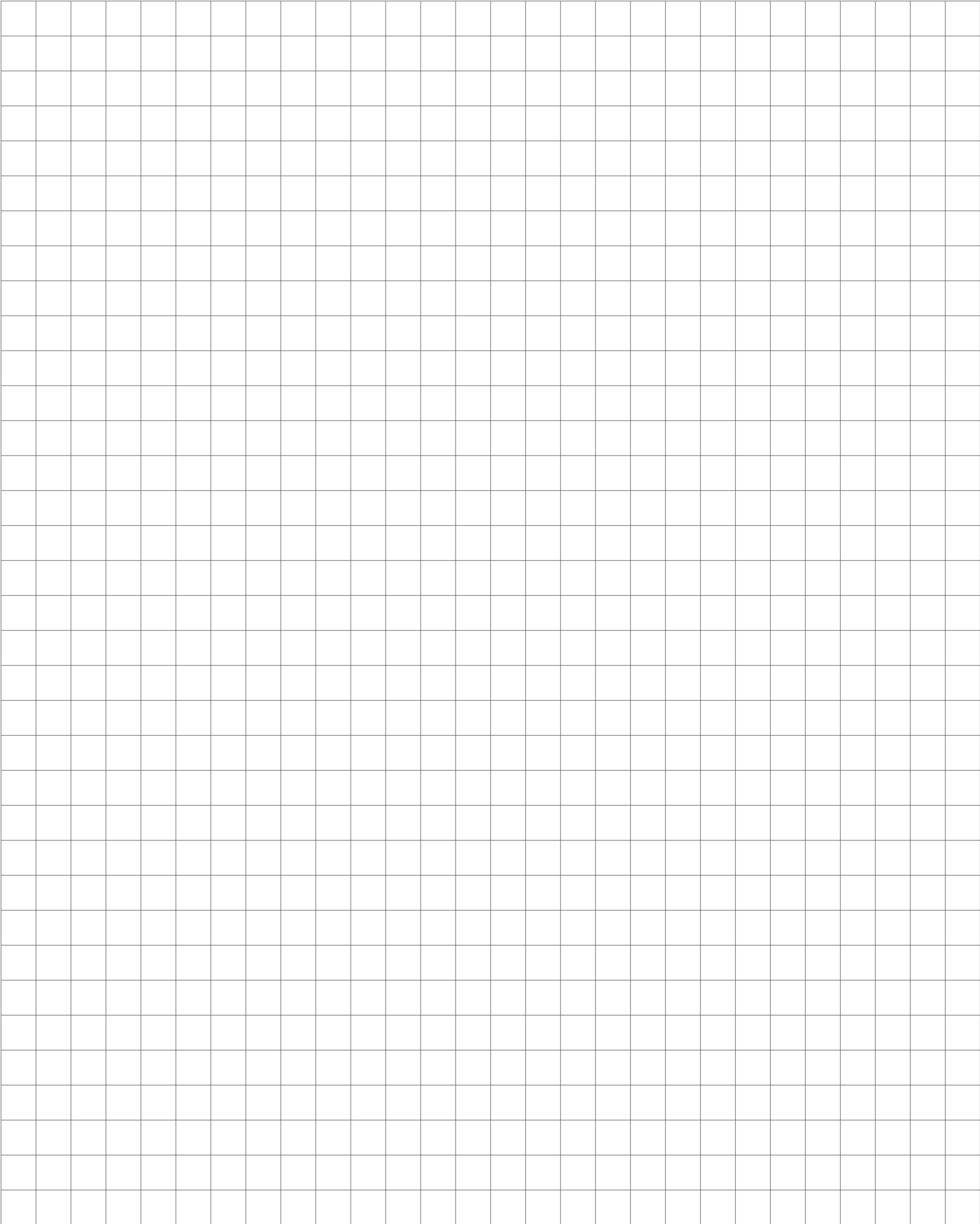



## CONTACT US

**ADDRESS**  
9221 Edison  
Montreal, Quebec,  
H1J 1T4, Canada

**FAX**  
1.514.903.0649

**EMAIL**  
[info@lumentruss.com](mailto:info@lumentruss.com)

**PHONE**  
1.855.384.3384

**WEBSITE**  
[www.lumentruss.com](http://www.lumentruss.com)



**MADE IN  
NORTH AMERICA**

**LUMEN™  
Truss**